



Procurement Department

INVITATION FOR BIDS (IFB)

FOR

Cassiano Burn Units Rehabilitation

FOR

**HOUSING AUTHORITY OF THE
CITY OF SAN ANTONIO, TEXAS
AND
AFFILIATED ENTITIES**

IFB# 1905-909-23-4929

Prepared by:

**Department of Procurement
Of the
San Antonio Housing Authority
818 South Flores Street
San Antonio, Texas 78204**

President & CEO David Nisivoccia

**Invitation For Bids
For
Cassiano Burn Units Rehabilitation**

The Housing Authority of the City of San Antonio, Texas and its affiliated entities d/b/a San Antonio Housing Authority ("SAHA") hereby invites qualified independent Contractors to submit bids for the rebuilding of a 7 fire and water damaged units at the Cassiano Homes Apartment Complex.

As a part of our social mission and federal mandate, SAHA is committed to providing economic, training and educational opportunities to the low income individuals in the communities we serve. All contractors are required to recruit and hire low income individuals for new positions and provide training & educational opportunities to the greatest extent feasible for these individuals.

The Invitation for Bids can be obtained by calling 210-477-6059 or online at

www.saha.org

<http://nahro.economicengine.com>

<http://www.publicpurchase.com/gems/saha.tx/buyer/public/home>

Notice: Contact with members of the SAHA Board of Commissioners, or SAHA officers and employees other than the contact person listed herein, by any prospective Bidder, after publication of the IFB and prior to the execution of a contract with the successful bidder(s) could result in disqualification of your bid. In fairness to all prospective bidder(s) during the IFB process, if SAHA meets in person with anyone representing a potential provider of these services to discuss this IFB other than at the pre-submittal meeting, an addendum will be issued to address all questions so as to insure no Bidder has a competitive advantage over another. This does not exclude meetings required to conduct business not related to the IFB or possible personal presentations after written qualifications have been received and evaluated.

HOUSING AUTHORITY OF THE
CITY OF SAN ANTONIO, TEXAS

Table of Contents

IFB Information at a Glance	4
Introduction	5
General Information	6
SAHA Reservation of Rights	6
General Conditions	8
Conditions to Bid	14
Form of Bid	16
Mistake in Bid	18
Insurance Requirements	19
Invoicing	20
Right to Protest	21
Additional Considerations	22
Attachments:	
Attachment - A Specifications & Estimated Construction Quantities	
Attachment - B HUD Forms and Conflict of Interest Questionnaire	
Attachment - C Profile of Firm Form	
Attachment - D Section 3 Guidelines and Forms	
Attachment - E Wage Decision	
Attachment - F Form of Bid, Bid Fee Sheet	

IFB INFORMATION AT A GLANCE

POINT OF CONTACT	Charles Bode Assistant Director of Procurement Phone: (210) 477-6703 Fax: (210) 477-6167 charles_bode@saha.org
DATE ISSUED	June 24, 2019
NON-MANDATORY PRE-SUBMITTAL MEETING	July 9, 2019 at 10:00 a.m. SAHA Central Office, 818 S. Flores, San Antonio, TX 78204
LAST DATE FOR QUESTIONS	July 11, 2019 at 3:00 p.m.
SITE VISIT	July 10, 2019 1:00 pm to 4:00 pm
BID DUE DATE	July 22, 2019 at 2:00 p.m. SAHA Procurement Dept. 818 S. Flores, San Antonio, TX 78204
ANTICIPATED APPROVAL BY THE BOARD	August/September 2019
SUBMITAL REQUIREMENTS	1 (one) Original signature document marked "ORIGINAL" and 2 (two) exact copies marked "COPY" in a sealed envelope or container.

INTRODUCTION

The San Antonio Housing Authority (SAHA) is a public housing agency created by resolution of the City of San Antonio in 1938 pursuant to the Texas Housing Authorities Law (now Chapter 392 of the Texas Local Government Code) and federal law. SAHA is a unit of government and its functions are essential governmental functions. The property of SAHA is used for essential public and governmental purposes and is exempt from all taxes, including sales tax on all its purchases of supplies and services.

SAHA enters into and executes contracts and other instruments that are necessary and convenient to the exercise of its powers. SAHA maintains contractual arrangements with United States Department of Housing and Urban Development (HUD) to manage and operate its low rent public housing program and administers the Section 8 Housing Assistance Payments Programs. SAHA programs are federally funded along with development and modernization grants and rental income.

Its primary activity is the ownership and management of over 6,300 public housing units. It also administers rental assistance for almost 12,000 privately owned rental units through the Section 8 program. It operates and manages its housing developments to provide decent, safe, sanitary and affordable housing to low income families, the elderly, and the disabled, and implements various programs designed and funded by HUD.

SAHA has created a number of affiliated public facility corporations (“PFCs”) pursuant to Chapter 303 of the Texas Local Government Code (the Public Facility Corporation Act). In some instances, these PFCs own projects. In other cases, PFCs or other related entities serve as partners in partnerships that have been awarded low-income housing tax credits. SAHA’s affiliated entities own and operate over 3,000 units of affordable housing.

SAHA staff also manages the San Antonio Housing Finance Corporation (“Finance Corporation”), which is primarily a conduit issuer of bonds for developers of affordable housing projects. The Finance Corporation was created pursuant to Chapter 394 of the Texas Local Government Code (the Texas Housing Finance Corporations Act). When used herein, “SAHA” shall include its affiliated entities.

INVITATION FOR BID

1.0 GENERAL INFORMATION

- 1.1 **Statement of Purpose:** The Housing Authority of the City of San Antonio and its affiliated entities (SAHA) are seeking bids from independent contractors with demonstrated professional competence and experience to provide for the rehabilitation of 7 fire and water damaged units at the Cassiano Homes Apartments as specified herein.
- 1.2 Bidders acknowledge that submitting a bid to SAHA is not a right to be awarded a contract, but only an offer by the Bidder to perform the requirements of the IFB documents in the event SAHA decides to award a contract to that Bidder.
- 1.3 **Non-Mandatory Pre-Bid Conference:** A pre-bid conference will be held at SAHA Central Office, located at 818 South Flores, San Antonio, Texas 78204 as indicated herein. The purpose of this conference is to assist Bidders in understanding of the IFB documents and required submittal documents. At this conference, SAHA will conduct an overview of the IFB documents, including attachments. Any questions concerning the scope must be presented in writing (e-mail is acceptable) to the contact person listed herein and will be answered in an addendum.
- 1.4 **Bidder's Responsibilities-Contact with SAHA:** Bidders shall address all communication and correspondences pertaining to this IFB process to contact listed herein only. Bidders must not inquire or communicate with any other SAHA staff member or official (including members of the Board of Commissioners) pertaining to this IFB. Failure to abide by this requirement is cause for a bid to be disqualified. During the IFB solicitation process, SAHA will not conduct any ex parte conversations which may give one prospective Bidder an advantage over other prospective Bidders.

2.0 SAHA'S RESERVATION OF RIGHTS

- 2.1 SAHA reserves the right to reject any or all bids, to waive any informality in the IFB process, or to terminate the IFB process at any time, if deemed by SAHA to be in its best interests.
- 2.2 SAHA reserves the right not to award a contract pursuant to this IFB.
- 2.3 SAHA reserves the right to terminate a contract awarded pursuant to this IFB, at any time for its convenience upon 30 days written notice to the successful Bidder(s).
- 2.4 SAHA reserves the right to determine the days, hours and locations that the successful Bidder(s) shall provide the services called for in this IFB.

- 2.5** SAHA reserves the right to retain all bids submitted and not permit withdrawal for a period of 90 days subsequent to the deadline for receiving bids without the written consent from SAHA.
- 2.6** SAHA reserves the right to reject and not consider any bid that does not meet the requirements of this IFB, including but not necessarily limited to incomplete bids and/or bids offering alternate or non-requested services and from individuals deemed non responsible.
- 2.7** SAHA shall have no obligation to compensate any Bidder for any costs incurred in responding to this IFB.
- 2.8** SAHA reserves the right to at any time during the IFB or contract process to prohibit any further participation by a Bidder or reject any bids submitted that does not conform to any of the requirements detailed herein. Each prospective Bidder further agrees that he/she will inform SAHA in writing within five (5) days of the discovery of any item that is issued thereafter by SAHA that he/she feels needs to be addressed. Failure to abide by this timeframe shall relieve SAHA, but not the prospective Bidder, of any responsibility pertaining to such issue.
- 2.9** SAHA reserves the right to, prior to award, revise, change, alter or amend any of the instructions, terms, conditions, and/or specifications identified within the IFB documents issued, within any attachment or drawing, or within any addenda issued. All addenda will be posted on SAHA's website www.saha.org, www.publicpurchase.com and <https://nahro.economicengine.com>. Such changes that are issued before the bid submission deadline shall be binding upon all prospective Bidders.
- 2.10** In the case of rejection of all bids, SAHA reserves the right to advertise for new bids or to proceed to do the work otherwise.
- 2.11** SAHA reserves the right to, without any liability; cancel the award of any bid(s) at any time before the execution of the contract documents by all parties.
- 2.12** SAHA reserves the right to add or delete to the estimated or actual quantities, shown herein, in whatever amount necessary, including complete properties, without prejudice or liability to SAHA, if:
- 2.12.1** Funding is not available,
- 2.12.2** Legal restrictions are placed upon the expenditure of monies for this category of service or supplies; or,
- 2.12.3** SAHA's requirements in good faith change after award of the contract.
- 2.13** SAHA reserves the right to make an award to more than one Bidder based on cost and the Bidder being considered responsive and responsible.

- 2.14 SAHA reserves the right to require additional information from all Bidders to determine level of responsibility. Such information shall be submitted in the form and time frame required by SAHA.
- 2.15 SAHA reserves the right to require the Contractor to keep accurate timesheets for all employees assigned to perform any project, task, or assignment resulting from this IFB and any resulting contract.
- 2.16 SAHA reserves the right to contact any individuals, entities, or organizations that have had a business relationship with the Bidder regardless of their inclusion in the reference section of the bid submittal.
- 2.17 In the event any resulting contract is prematurely terminated due to non-performance and/or withdrawal by the Contractor, SAHA reserves the right to seek monetary restitution (to include but not limited to withholding of monies owed) from the Contractor to cover costs for interim services and/or cover the difference of a higher cost (difference between terminated Contractor's rate and new company's rate) beginning the date of Contractor's termination through the contract expiration date.
- 2.18 SAHA reserves the right to amend the contract any time prior to contract execution.

3.0 **GENERAL CONDITIONS:**

- 3.1 **SPECIFICATIONS:** The Contractor shall provide the goods or services as specified in this IFB and any attached HUD Documents. Specifications are in Attachment A.
- 3.2 **REGULATORY/LICENSING:** Contractor shall comply with all applicable federal, state and local laws, rules, regulations, ordinances and codes and obtain any licenses or permits required to provide the services under this IFB. Obtaining licenses and permits shall be the sole responsibility of the successful Bidder whether or not they are known to either the SAHA or the Bidders at the time of the submittal deadline or the award.
- 3.3 **SECTION 3: Contactor is required to prepare and submit monthly reports on Section 3.** Contractor shall utilize Section 3 residents and businesses as defined in Attachment D to perform the requirements under this IFB to the greatest extent feasible and shall document such efforts monthly. There is a 30% goal for hiring Section 3 residents on any contract resulting from this IFB, a subcontracting goal of 10% for Section 3 Businesses for construction contracts and a subcontracting goal of 3% with Section 3 Businesses for non-construction contracts. Contractors will be evaluated on their performance at achieving this goal and such evaluation shall be a factor in future awards.
FAILURE TO PROVIDE A SECTION 3 PLAN MAY CAUSE THE SUBMITTAL TO BE DISQUALIFIED AS NON-RESPONSIVE.

- 3.4 SMALL, WOMAN, MINORITY BUSINESS ENTERPRISES (SWMBE):** The Proposer is required to include a plan identifying the Proposer's good faith efforts to assist SAHA in its responsibility to foster the development of small and historically under-utilized business enterprises including woman owned, minority owned, disabled veteran owned business enterprises and other business enterprises owned and recognized by HUD as having privileged status. **All** subcontracting opportunities shall be outlined in this plan and any subcontractors listed on the Subcontractor's form provided in Attachment C. **FAILURE TO PROVIDE A SWMBE PLAN MAY CAUSE THE SUBMITTAL TO BE DISQUALIFIED AS NON-RESPONSIVE.**
- 3.5 RESPONSIBILITY FOR SUBCONTRACTORS:** All requirements for the "Prime" contractor shall also apply to any and all subcontractors. It is the Prime Contractors' responsibility to insure the compliance by the subcontractors. Regardless of subcontracting, the Prime Contractor remains liable to SAHA for the performance under this IFB or any resulting contract.
- 3.6 CRIMINAL HISTORY/DRUG TESTING;** Contractor shall perform criminal history checks and drug screening tests on all employees performing work under this IFB and any resulting contract and if requested provide summaries of the results to SAHA. Prospective employees whose criminal history checks discloses a misdemeanor or felony conviction involving crimes of moral turpitude or harm to persons or property shall not be used to perform work under this IFB or any resulting contract. Contractor is required to perform drug screening of all employees and to insure acceptable test results. Criminal history and drug screening checks will be completed at the sole expense of the Contractor.
- 3.7 LIQUIDATED DAMAGES:** For each day that performance under a resulting contract from this IFB is delayed beyond the time specified for completion, the successful Bidder shall be liable for liquidated damages in the amount of \$25.00 per day. However, the timeframe for performance may be adjusted at SAHA's discretion in writing and received by the successful Bidder prior to default under any resulting contract.
- 3.8 UNACCEPTABLE EMPLOYEES:** If any employee of the Contractor is deemed unacceptable by SAHA, Contractor shall immediately replace such personnel with a substitute acceptable to SAHA.
- 3.9 UNIFORMS/BADGES:** Contractor shall provide uniforms and/or ID badges for all employees working on SAHA's properties. No employee will be allowed on SAHA's properties out of uniform and/or without an ID badge.
- 3.10 WARRANTY:** All items installed/provided under any contract resulting from this IFB must include a minimum of a two (2) year warranty from the Contractor for labor, materials, and installation except as specified otherwise herein. This period will begin on the date of "FINAL" acceptance by SAHA.

- 3.10.1** The services provided under the contract shall conform to all information contained within the IFB documents as well as applicable Industry Published Technical Specifications, and if one of the above mentioned Specifications contains more stringent requirements than the other, the more stringent requirements shall apply.
- 3.10.2** In addition to all other warranties, the warranty shall include the warranty for merchantability and the warranty of fitness for a particular purpose.
- 3.10.3** Contractor shall assign any warranties and guarantees to SAHA and provide the Contractor's Warranty for Labor and Installation to SAHA along with all Manufacturers' Warranty documents.
- 3.11 SUBMISSIONS:** Late submissions will not be accepted. Submissions received prior to the opening will be held in confidence until the opening.
- 3.12 PROPOSED COST:**
- 3.12.1 Base Costs:** Your proposed fee for each item is inclusive of all necessary costs to provide the proposed services, including, but not limited to: employee costs and benefits; clerical support; overhead; profit; supplies; materials; licensing; insurance, vehicle fuel, etc. Each fee proposed shall be fully "burdened" with profit and overhead costs.
- 3.12.2 Unit Prices:** Your proposed unit price for each item listed on the Unit Price Sheet, if required, shall be inclusive of all expenses incurred to perform the service or install the item under this IFB and any resulting contract. Unit Price shall include but not be limited to, employee costs and benefits, clerical support, overhead, profit, supplies, materials, equipment, licensing, insurance, bonding, vehicle fuel, etc. In case of a discrepancy between a unit price and an extension the unit price prevails.
- 3.12.3** Contractor shall provide at contractor's own expense all equipment, labor, materials, supplies, and tools unless specified otherwise.
- 3.13 Taxes:** SAHA, as a governmental entity, is exempt from Texas State Sales and Use Taxes and Federal Excise Taxes. A letter of Tax Exemption will be provided upon request.
- 3.14 Delivery:** All costs submitted by the successful Bidder shall reflect the cost of delivering the proposed items and/or services to the locations specified within the IFB documents or within the Agreement. All costs in the bid submittal shall be quoted as FOB Destination, Freight Prepaid and allowed unless otherwise stated in this IFB.

- 3.14.1** The successful Bidder agrees to deliver to the designated location(s) on or before the date as specified in the finalized contract. Failure to deliver on or before the specified date constitutes an event of default by the successful Bidder. Upon default, the successful Bidder agrees that SAHA may, at its option, rescind the finalized contract under the termination clause herein and seek compensatory damages as provided by law.
- 3.15 “Or Equal”:** Catalogs, brand names or manufacturer’s references where provided are descriptive only and indicate type and quality desired. Bids on brands of like nature and quality will be considered unless specified otherwise. If bidding other than the referenced manufacturer, brand or trade name, Bidder must provide a complete description of product offered, and illustrations and must be included in the bid submittal. Failure to include the above referenced data will require Contractor to furnish the specified brand names, numbers, etc.
- 3.16 TYPE OF CONTRACT:** Firm fixed contract with the option to extend at the sole discretion of SAHA.
- 3.17 BID GUARANTEE, PERFORMANCE AND PAYMENT BONDS:** All Surety Bonds shall be issued by companies licensed to do business in the State of Texas, approved by the U.S. Treasury and “A” rated or better by A. M. Best. Individual Sureties will not be accepted.
- 3.17.1** SAHA requires a Bid Guarantee for this bid in the amount of 5% of the Base Bid, which shall be submitted with the Bid Fee Sheet. Proposals without a Bid Guarantee will be rejected. Non surety Bid Guarantees must be in guaranteed funds such as: Cashier’s Check, Certified Check, Bank Draft, irrevocable letter of credit, or similar cash instrument.
- 3.17.2** Performance Bond: The Contractor must provide SAHA a 100% Performance Bond for total contract value, however if the Contractor is unable to acquire the equitable bonding that is acceptable to SAHA within ten (10) days of signed contract, then the Contractor will be deemed in breach of contract.
- 3.17.3** Payment Bond: The Contractor must provide SAHA a 100% Payment Bond for each Project Contract executed by SAHA, however if the Contractor is unable to acquire the equitable bonding that is acceptable to SAHA within ten (10) days of signed contract, then the Contractor will be deemed in breach of contract.
- 3.18 PERMITS:** Permits are the responsibility of the awarded contractor.

3.19 COMMUNICATIONS:

3.19.1 Form: All claims, notices, demands, requests, instructions, approvals and proposals must be submitted in writing.

3.19.2 Notice to Contractor: Any Notices or Demands upon the Contractor shall be sufficiently given if delivered at the office of the Contractor stated on the signature page of the Contract or at such other office as he / she may from time to time designate in writing to SAHA or deposited in the United States mail in a sealed, postage-prepaid envelope or if delivered with charges prepaid to any telegraph company for transmission and addressed to the office of the Contractor indicated on the signature page of the contract or such other address as may be subsequently specified in writing to SAHA.

3.19.3 Notice to SAHA: All notification papers required to be delivered to SAHA or its designated representative shall, unless otherwise specified in writing to the Contractor, be delivered to attn. Procurement, SAHA at 818 South Flores, San Antonio, Texas, 78204; and any notice to or demand upon SAHA shall be sufficiently given if so delivered or deposited in the United States mail in a sealed, postage-prepaid envelope or delivered with charges prepaid to any telegraph company for transmission to SAHA at the above address or to such other address as SAHA may subsequently specify in writing to the Contractor for such purpose.

3.19.4 Receipt: Any such notice shall be deemed to have been given as of the time of actual delivery; or in the case of mailing, when the same should have been received in due course after the date of surrender to the Post Office; or in the case of telegrams, at the time of actual receipt, as the case may be.

3.20 Calculations: The Contractor is responsible for field verifying the conditions and quantities required to deliver a complete and functional project. This shall include but is not limited to: demolition, disposal, preparation, installation, overhead, profit, bonding, general liability, labor burden, weather conditions, field verified quantities, and encumbrances. All Proposers' submitted Unit Price Items must include these variables. SAHA shall not pay additional sums for a Proposer's failure to factor these conditions into the Proposals. Failure to consider any of the factors listed shall not negate the Contractor's responsibility to perform if awarded a contract under this IFB.

3.20.1 Estimated Quantities: Any quantities provided herein are strictly estimates unless specified otherwise. It is the Proposer's responsibility to determine the exact quantities required to provide a complete, finished, functional, and operational product. Unit prices, if requested, are to be utilized only for additional work requested by SAHA.

- 3.21 Project Occupancy:** For the purposes of this solicitation the development shall be considered fully occupied. The project site may also have various construction zones, phasing, mobilization, as well as other Contractors working on-site. Proposers must include these variables in their proposed fees. SAHA shall not pay additional sums for a proposer's failure to factor these conditions into their submittal.
- 3.22 Time for Completion:** The Contractor shall immediately mobilize and commence work at the time stipulated in the Notice to Proceed to the Contractor and shall be fully completed within **200 days** unless specified otherwise in contractor's response.
- 3.23 Safety:** Subject to prior approval by SAHA as to size, design, type and location, and to local regulations, the Contractor and his / her subcontractors shall erect Temporary Safety Signs for purposes of identification and controlling traffic. The Contractor shall furnish, erect, and maintain such signs as may be required by safety regulations and as necessary to safeguard life and property.
- 3.24 Builders Risk:** Contractor is required to acquire Builder's Risk Insurance for any project or projects resulting from this solicitation. In any case SAHA will not be responsible for any loss to Contractor's tools, materials, supplies, the building or project or any other coverage normally covered under Builder's Risk Insurance. See HUD form 5370 attached.
- 3.25 Storage:** The Contractor and his/her subcontractors may maintain with approval by the SAHA Property & Project Managers various Storage Facilities on the site as may be necessary in the proper conduct of the work. These shall be located to cause no interference with any work to be performed on the site by the Contractor or others. The Contractor shall consult with SAHA regarding the location(s) of these facilities on each site.
- 3.26 Removal of Temporary Facilities:** Upon completion of the project, or as directed by SAHA, the Contractor shall remove all temporary structures and facilities they installed from the site and leave the premises in equal or better condition than it was at turnover.
- 3.27 Final Inspection:**
- 3.27.1 Notice:** The Contractor shall provide prompt written notification to SAHA when all work is completed. A final project inspection shall be made when all work is completed. Until the final inspection has been made and project accepted by SAHA, SAHA shall not advance any of the retainage or make the final payment to the Contractor without the approval and concurrence of the Contracting Officer.
- 3.27.2 Inspection Date:** Upon receipt of the Contractor's notification of the date when the work has been completed, SAHA shall conduct a final Inspection within 2 calendar days.

3.27.3 Inspection Participants: The final inspection shall be conducted by a SAHA representative/s, any System Manufacturer's Representative/s, and the Contractor's representative/s at a minimum.

3.27.4 Inspection Conference: The inspection team shall meet after completing the final inspection to determine whether the work has been completed in accordance with these specifications and produce a Punch List Schedule which describes any minor items of incomplete or unsatisfactory work and document if there are any major deficiencies which must be corrected by the Contractor and additional inspections scheduled prior to contract settlement.

3.28 Settlement Documents: The settlement document shall state that the work was completed in accordance with the construction documents, including change orders except any minor items identified on SAHA's proposed certificate of completion, the total amount due the Contractor and a separately stated amount for each unsettled claim against SAHA. It shall also state that SAHA is released of all liens and all claims except those expressly stated in the Contractor's release and that wages paid to laborers or mechanics were consistent with the wage rate requirements of the contract and there are no outstanding claims for unpaid wages, materials, or supplies.

3.29 Wage Rate: The Davis Bacon and Related Acts wage and reporting requirements apply to this project.

3.30 Other Products and Services: Should the awarded Vendor either now or in the future offer or provide other related products or services SAHA reserves the right to obtain a quote for those products or services from the Vendor and if SAHA deems the fees and the product or service fair and reasonable and of substantial benefit to SAHA the product or service may be purchased under the terms of this solicitation and its subsequent contract as though the product or service was included in the solicitation and contract, or SAHA may choose to procure through other methods.

4.0 CONDITIONS TO PROPOSE:

4.1 Pre-Qualification: Bidders will not be required to pre-qualify in order to submit a bid. However, all Bidders will be required to submit adequate information showing that the bidder is qualified to perform the required work (i.e. Profile of Firm Form, Attachment C). Failure by the prospective Bidder to provide the requested information may, at SAHA's discretion, eliminate that Bidder from consideration, provided that all Bidders were required to submit the same information.

4.2 IFB Forms, Documents, Specifications and Drawings:

4.2.1 It shall be each Bidder's responsibility to examine carefully and, as may be required, properly complete all documents issued pursuant to this IFB.

4.2.2 Unless otherwise instructed, specifications and drawings (if provided) do not purport to show all of the exact details of the work. They are intended to illustrate the character and extent of the performance desired under the proposed contract and may be supplemented or revised from time to time.

4.3 Submission and Receipt by SAHA:

4.3.1 Time for Receiving Bids: Bids received prior to the submittal deadline shall be securely kept, unopened, by SAHA. No bid received after the designated deadline shall be considered.

4.3.1.1 Bidders are cautioned that any bid submittal that is time-stamped as being received by SAHA after the exact time set as the deadline for the receiving of bids shall be returned unopened to the Bidder. Any such bids inadvertently opened shall not be considered, but shall be ruled to be invalid. No responsibility will attach to SAHA or any official or employee thereof, for the pre-opening of, or the failure to open a bid not properly addressed and identified.

4.3.1.2 A total of one (1) original signature copy (marked "Original") and 2 exact copies (marked "Copy") shall be forwarded to the Procurement Dept. with the Bidder's name and return address and addressed as follows:

IFB # {Insert Number}
{Insert Exact Title of IFB}
{Insert Month, day, year, Time of Bid Opening}
The Housing Authority of the City of San Antonio
Procurement Department
818 S. Flores
San Antonio, Texas 78204

4.3.5 Withdrawal of Bids: Bids may be withdrawn as detailed in attached HUD Document (Attachment B). Negligence on the part of the Bidder in preparing his/her bid confers no right of withdrawal or modification of his/her bid after such bid has been received and opened.

4.3.5.1 Procedure to withdraw bid submittal: A request for withdrawal of a bid due to a purported error need not be considered by SAHA unless filed in writing by the Bidder within 48 hours after the bid deadline. Any such request shall contain a full explanation of any purported error and shall, if requested by SAHA, be supported by the original calculations on which the bid was computed, together with a certification and notarization thereon that such computation is the original and was prepared by the Bidder or his/her agent, who must be identified on the

notarized form. The foregoing shall not be construed that such withdrawal will be permitted, as SAHA retains the right to accept or reject any proposed withdrawal for a mistake.

4.4 Questions/Inquires:

4.4.1 A Bidder may inquire or question any of the bid documents or any part of the information contained therein, by submitting, in writing to the contact person listed herein, at least eight (8) days prior to the bid submission deadline, a complete and specific explanation as to what he/she is requiring clarification. SAHA reserves the right to issue a revision to the applicable IFB requirements or may reject the Bidder's request.

4.4.2 Bidders must propose services that meet the requirements of the IFB documents. Substitutions to the specification and/or approved "equal" requests may be discussed at the scheduled pre-bid conference (if scheduled). All verbal instructions issued by the SAHA officers not already listed within the IFB documents shall only become official when issued as addenda or as a written answer issued pursuant to receipt of a written question.

5.0 **FORM OF BID:** The bid shall be submitted in the following manner. Failure to submit the bid in the manner specified may result in a premature opening of, post-opening of, or failure to open and consider that bid and may be cause for elimination of that Bidder from consideration for award.

5.1 **Tab 1, Form of Bid, Bid Fee Sheet, and Bidder's Certification:** These Forms are attached hereto as Attachment F to this IFB document. These Forms must be fully completed, and submitted under this tab. Any exceptions to the specifications or terms must be placed under this tab and "CLEARLY" labeled as such. Placement elsewhere shall render them null and void and they will not be considered.

5.2 **Tab 2, HUD Forms and Conflict of Interest Questionnaire:** These Forms are attached hereto as Attachment B to this IFB document and must be completed, executed where provided thereon and submitted under this tab.

5.3 **Tab 3, Profile of Firm Form:** The Profile of Firm Form is attached hereto as Attachment C to this IFB document. This two-page Form must be completed, executed and submitted under this tab.

5.4 **Tab 4, Client Information:** The Bidder shall submit three former or current clients, preferably other than SAHA, for whom the Bidder has performed similar or like services to those being proposed herein. The list shall, at a minimum, include for each reference:

5.4.5.1 The client's name;

5.4.5.2 The client's telephone number and address,

5.4.5.3 Description of services provided to the client, and

5.4.5.4 Date of services

- 5.5 Tab 5, Joint Venture/Partnerships:** The Bidder shall identify if this bid is a joint venture or partnership with another entity. Please remember that all information required from the Bidder under the proceeding or subsequent tabs must also be included for any joint venture or partner. One entity must be designated as the primary contact for the joint venture or partnership in the bid. Include a Profile of Firm Form for each entity. If no joint venture or partnership exists or will not be utilized, please provide this statement, “NO JOINT VENTURE/ NO PARTNERS”
- 5.6 Tab 6, Subcontractors:** Bidders must also provide SAHA with the name, contact information to include address, phone number, email address, core area of business, and years of expertise for each subcontractor and supplier and the minority status of each. A Profile of Firm Form must be completed for each subcontractor and included in this Tab. Bidder must realize that the actual usage of the subcontractor will be contingent upon SAHA’s prior written approval, and Bidder remains responsible to SAHA for any and all services and goods provided pursuant to this IFB and any resulting contract. If no subcontractors will not be utilized, please provide this statement, “NO SUBCONTRACTORS” “Contractor intends to perform all work detailed in this IFB”.
- 5.7 Tab 7, Section 3 Business Preference:** Any Bidder claiming a Section 3 Business Preference, shall under this tab include the fully completed and executed Section 3 applicant certification form for low-income employees for whom Bidder is seeking the preference, verification of total number of full-time employees, names and addresses of low-income residents who are Bidders employees. **Note: If you qualify as a Section 3 Business Concern, your bid will receive a preference over other bids as specified in Attachment D.**
- 5.8 Tab 8, Small/Minority/Disadvantaged/Veteran Business Enterprise Utilization Plan:** The Bidder is required to include hereunder a plan to assist SAHA in its responsibility to foster the development of small and historically under-utilized business enterprises by identifying subcontracting opportunities with SWMBE companies. Contractor is required to show a good faith effort to employ SWMBE firms in the execution of this project. **FAILURE TO PROVIDE A S/W/MBE PLAN MAY CAUSE THE RESPONSE TO BE DISQUALIFIED AS NON-RESPONSIVE.**
- 5.9 Tab 9, Section 3 Good Faith Effort Compliance Plan:** Bidders are required to complete and submit the SECTION 3 PROGRAM GOOD FAITH EFFORT COMPLIANCE PLAN outlining their efforts to employ qualified Section 3 businesses or persons. The goal as stated in the Good Faith Effort Compliance Plan is thirty percent of new hires for Section 3 persons per contract. The subcontracting goal is ten percent for Section 3 Businesses for construction contracts and three percent for Section 3 Businesses for non-construction contracts. SAHA will provide a listing of qualified Section 3 Businesses upon request. **FAILURE TO PROVIDE THE SECTION 3 PROGRAM GOOD FAITH EFFORT COMPLIANCE PLAN MAY CAUSE THE RESPONSE TO BE DISQUALIFIED AS NON-RESPONSIVE**

5.10 Tab 10, Financial Viability and Other Information: Financial ability to provide such services to include copies of most recent financial statements and most recent audit if available. The Bidder may also include hereunder any other general information and copies of any licenses held or required.

5.11 Bid Submittal Binding Method: It is preferable and recommended that the Bidder bind the bid submittals in such a manner that SAHA can, if needed, remove the binding (i.e. "comb-type, etc.) or remove the pages from the cover (i.e. 3-ring binder, etc.) to make copies then return the bid submittal to its original condition.

6.0 MISTAKE IN BID

6.1 After a bid has been opened it may not be changed for the purpose of correcting an error in the pricing. This does not affect the common law right of the bidder to withdraw a bid due to a material mistake in the bid.

6.2 Irregular Bid Submittal: A bid shall be considered irregular for any one of the following reasons, any one or more of which may be reason for rejection:

6.2.1 If the forms furnished by SAHA are not used or are altered or if the bid costs are not submitted as required and where provided.

6.2.2 If all requested completed attachments do not accompany the bid submittal.

6.2.3 If there are unauthorized additions, conditional or alternate bids, or irregularities of any kind which may tend to make the bid incomplete, indefinite or ambiguous as to its meaning or give the Bidder submitting the same a competitive advantage over other Bidders.

6.2.4 If the Bidder adds any provisions reserving the right to accept or reject any award or to enter into a contract pursuant to an award.

6.2.5 If the individual cost bid items submitted by a specific Bidder are unbalanced in the sense that the listed price of any cost item departs by more than 25% from SAHA's cost estimate for that item.

6.3 Disqualification of Bidders: Any one or more of the following shall be considered as sufficient for the disqualification of a prospective Bidder and the rejection of his/her bid:

6.3.1 Evidence of collusion among prospective Bidders. Participants in such collusion will receive no recognition as Bidders or Proposer for any future work with SAHA until such participant shall have been reinstated as a qualified Bidder or Proposer. The names of all participants in such collusion shall be reported to HUD and any other inquiring governmental agency.

- 6.3.2** More than one bid for the same work from an individual, firm, or corporation under the same or different name(s).
- 6.3.3** Lack of competency, lack of experience and/or lack of adequate machinery, plant and/or other resources.
- 6.3.4** Unsatisfactory performance record as shown by past work for SAHA or with any other local, state or federal agency, judged from the standpoint of workmanship and progress.
- 6.3.5** Incomplete work, which in the judgment of SAHA, might hinder or prevent prompt completion of additional work, if awarded.
- 6.3.6** Failure to pay or satisfactorily settle all bills due on former contracts still outstanding at the time of letting.
- 6.3.7** Failure to comply with any qualification requirements of SAHA.
- 6.3.8** Failure to list, if required, all subcontractors (if subcontractors are allowed by SAHA) who will be employed by the successful Bidder(s) to complete the work of the proposed contract.
- 6.3.9** As required by the IFB documents, failure of the successful Bidder to be properly licensed by the City, County and/or the State of Texas and/or to be insured by a commercial general liability policy and/or worker's compensation policy and/or business automobile liability policy, if applicable. If a Bidder receives an award unless otherwise waived in the Contract, the Contractor will be required to provide original certificates of the following insurance requirements to SAHA within 10 days of contract signature:
- 6.3.10** Any reason to be determined, in good faith, to be in the best interests of SAHA.

7.0 Award of Bids(s): Bidders shall be recommended for award if they are deemed responsive and responsible and provide the "Best Value" to SAHA. SAHA also reserves the right to award on a by property basis. In determining the best value SAHA may consider:

- 7.1** The purchase price;
- 7.2** The reputation of the bidder and his goods or services;
- 7.3** The quality of the goods or services;
- 7.4** The extent to which the goods or services meet SAHA's needs;
- 7.5** The total long term cost;
- 7.6** Any relevant criteria listed herein;

8.0 INSURANCE: If a Bidder receives an award and unless otherwise waived in the Contract, the Contractor will be required to provide an original Certificate of Insurance confirming the following minimum requirements to SAHA within 10 days of contract signature:

Professional Liability	Required Limits
SAHA and its affiliates must be named as an Additional Insured and be a Certificate Holder. This is required for vendors who render observational services to SAHA such as appraisers, inspectors, attorneys, engineers or consultants.	\$1,000,000 Not Required for this contract
Business Automobile Liability	Required Limits
SAHA and its affiliates must be named as an additional insured and as the certificate holder. This is required for any vendor that will be using their vehicle to do work on SAHA properties.	\$500,000 combined Single limit, per occurrence
Workers Compensation and Employer's Liability	Required Limits
Workers' Compensation coverage is Statutory and has no pre-set limits. Employer's Liability limit is \$500,000. Workers' Compensation is required for any vendor made up of more than two persons. A Waiver of Subrogation in favor of SAHA must be included in the Workers' Compensation policy. SAHA and its affiliates must be a Certificate Holder.	Statutory Employer's Liability is \$500,000
Commercial General Liability	Required Limits
This is required for any vendor who will be doing hands on work at SAHA properties. SAHA and its affiliates must be named as an Additional Insured and as the Certificate Holder.	\$1,000,000 per accident \$2,000,000 aggregate

9.0 INVOICING:

- 9.1** Contractor(s) will only be allowed to invoice for the cost of services/goods in compliance with his/ her bid or best and final offer as accepted by SAHA.
- 9.2** Invoices must contain a complete description of the work or service that was performed, the contract price for each service, the purchase order number, contract number (if applicable), date of service, and address of service location or delivery address.
- 9.3** Contractor(s) must submit a separate invoice for each purchase order issued by SAHA unless prior approval is obtained from SAHA.
- 9.4** If applicable, SAHA may make progress payments approximately every 30 days as the work proceeds if work meets owner's standards, as approved by the Contracting Officer. SAHA may, subject to written determination and approval of the Contracting Officer, make more frequent payments to contractors which are qualified small businesses in accordance with HUD documents.
- 9.5** Upon the Award of Contract, Contractor shall complete the direct deposit form from SAHA to process all payments electronically to insure prompt and efficient payment of all invoices.
- 9.6** If offered by Contractor, SAHA seeks a discount for early payment. SAHA shall only take such a discount if earned.

- 9.7** To insure prompt and timely payment of invoices, unless utilizing a progress payment schedule, invoices shall be sent to the following address:

Email invoices to: Accounts_Payable@saha.org

If the contractor does not have the capability to email invoices they may be sent to the following address:

San Antonio Housing Authority
Finance and Accounting
P.O. Box 830428
San Antonio, TX 78283-0428

- 9.8** Contractor shall invoice SAHA within 60 days after the delivery of the goods or service. If contractor fails to invoice within 60 days SAHA reserves the right to not pay the invoice.

10.0 **RIGHT TO PROTEST:**

- 10.1** Rights: Any prospective or actual proposer or contractor, who is allegedly aggrieved in connection with the solicitation of a bid or award of a contract, shall have the right to protest. Such right only applies to deviations from laws, rules, regulations, or procedures. Disagreements with the evaluators' judgments as to the number of points scored are not reasons for an appeal. An alleged aggrieved protestant claiming this right is hereby informed that these regulations do not provide for administrative appeal as a matter of right for that alleged aggrieved protestant.

10.1.1 Definition: An alleged aggrieved "protestant" is a prospective proposer or proposer who feels that he/she has been treated inequitably by SAHA and wishes SAHA to correct the alleged inequitable condition or situation.

10.1.2 Eligibility: To be eligible to file a protest with SAHA pertaining to an IFB or contract, the alleged aggrieved protestant must have been involved in the IFB process in some manner as a prospective proposer (i.e. recipient of the IFB documents) when the alleged situation occurred. SAHA has no obligation to consider a protest filed by any party that does not meet these criteria.

10.1.3 Procedure: Any actual or prospective contractor may protest the solicitation or award of a contract for material violation of SAHA's procurement policy. Any protest against a SAHA solicitation must be received before the due date for receipt of Bids and any protest against the award of a contract must be received within ten calendar days after contract award or the protest will not be considered.

All protests must be in writing and submitted to the Director of Procurement for a written decision. The Director of Procurement shall make a recommendation to the Contracting Officer who shall issue a written decision and findings to the Contractor within 30 days from receipt of the written protest. This decision is then appealable to the Board of Commissioners within 30 days of receipt of the written decision. Appeals which are not timely filed will not be considered and the decision becomes final. All appeals shall be marked and sent to the address as listed in the example below:

APPEAL OF IFB NO. {Insert IFB # here}
San Antonio Housing Authority
Procurement Department
818 South Flores,
San Antonio, TX 78204

11.0 **ADDITIONAL CONSIDERATIONS:**

- 11.1 Government Standards:** It is the responsibility of the prospective Bidder to ensure that all items and services proposed conform to all local, state and federal law concerning safety (OSHA) and environmental control (EPA and Bexar County Pollution Regulations) and any other enacted ordinance, code, law or regulation. The successful Bidder shall be responsible for all costs incurred for compliance with any such possible ordinance, code, law or regulation. No time extensions shall be granted or financial consideration given to the successful Bidder for time or monies lost due to violations of any such ordinance, code, law or regulations that may occur.
- 11.2 Work on SAHA Property:** If the successful Bidder's work under the contract involves operations on SAHA premises, the successful Bidder shall take all necessary precautions to prevent the occurrence of any injury to persons or property during the progress of such work and shall immediately return said property to a condition equal to or better than the existing condition prior to the commencement of work at the site at no cost to SAHA.
- 11.3 Estimated Quantities:** Unless otherwise indicated, the quantities shown are estimates only and are used to evaluate the responses and may or may not reflect anticipated purchases. SAHA does not guarantee any minimum purchase quantity.
- 11.4 Official, Agent and Employees of the SAHA Not Personally Liable:** It is agreed by and between the parties hereto that in no event shall any official, officer, employee, or agent of the SAHA in any way be personally liable or responsible for any covenant or agreement herein contained whether expressed or implied, nor for any statement, representation or warranty made herein or in any connection with this agreement.

- 11.5 Subcontractors:** Unless otherwise stated within the IFB documents, the successful Bidder may not use any subcontractors to accomplish any portion of the services described within the IFB documents or the contract without the prior written permission of SAHA. Also, any substitution of subcontractors must be approved in writing by SAHA prior to their engagement.
- 11.6 Salaries and Expenses Relating to the Successful Proposers Employees:** Unless otherwise stated within the IFB documents, the successful Bidder shall pay all salaries and expenses of, and all Federal, Social Security taxes, Federal and State Unemployment taxes, and any similar taxes relating to its employees used in the performance of the contract. The successful Bidder further agrees to comply with all Federal, State and local wage and hour laws and all licensing laws applicable to its employees or other personnel furnished under this agreement.
- 11.7 Independent Contractor:** Unless otherwise stated within the IFB documents or the contract, the successful Bidder is an independent contractor. Nothing herein shall create any association, agency, partnership or joint venture between the parties hereto and neither shall have any authority to bind the other in any way.
- 11.8 Severability:** If any provision of this agreement or any portion or provision hereof applicable to any particular situation or circumstance is held invalid, the remainder of this agreement or the remainder of such provision (as the case may be), and the application thereof to other situations or circumstances shall not be affected thereby.
- 11.9 Waiver of Breach:** A waiver of either party of any terms or conditions of this agreement in any instance shall not be deemed or construed as a waiver of such term or condition for the future, or of any subsequent breach thereof. All remedies, rights, undertakings, obligations, and agreements contained in this agreement shall be cumulative and none of them shall be in limitation of any other remedy, right, obligation or agreement of either party.
- 11.10 Time of the Essence:** Time is of the essence as to each provision in which a timeframe for performance is provided in this IFB. Failure to meet these timeframes may be considered a material breach, and SAHA may pursue compensatory and/or liquidated damages under the contract.
- 11.11 Limitation of Liability:** In no event shall SAHA be liable to the successful Bidder for any indirect, incidental, consequential or exemplary damages.
- 11.12 Indemnity:** The Contractor shall indemnify and hold harmless SAHA and its officers, agents, representatives, and employees from and against all claims, losses, damages, actions, causes of action and/or expenses resulting from, brought for, or on account of any bodily injury or death of an employee of the Contractor, its agent, or its subcontractor of any tier received or sustained by any persons or property growing out of, occurring, or attributable to any work performed under or related to this Agreement, resulting in whole or in part from the negligent acts or omissions of the Contractor, any subcontractor, or any

employee, agent or representative of the Contractor or any subcontractor, AND **REGARDLESS OF WHETHER CAUSED IN WHOLE OR IN PART BY THE NEGLIGENCE OF SAHA. CONTRACTOR ACKNOWLEDGES AND AGREES THAT THIS INDEMNITY CONTROLS OVER ALL OTHER PROVISIONS IN THE AGREEMENT, SURVIVES TERMINATION OF THIS AGREEMENT, AND APPLIES TO CLAIMS AND LIABILITY ARISING OUT OF THE SOLE OR CONCURRENT NEGLIGENCE OF SAHA.**

Contractor shall indemnify and hold harmless SAHA, their agents, consultants and employees from and against any and all property damage claims, losses, damages, costs and expenses relating to the performance of this Agreement, including any resulting loss of use, *but only to the extent caused by the negligent acts or omissions of Contractor*, its employees, sub-subcontractors, suppliers, manufacturers, or other persons or entities for whose acts Contractor may be liable.

11.13 Public/Contracting Statutes. SAHA is a governmental entity as that term is defined in the procurement statutes. SAHA and this IFB and all resulting contracts are subject to federal, state and local laws, rules, regulations and policies relating to procurement as applicable.

11.14 Termination: Any contract resulting from this IFB may be terminated under the following conditions:

11.14.1 Consent: By mutual consent of both parties, and

11.14.2 Termination For Cause: As detailed within the attached HUD Forms.

11.14.2.1 SAHA may terminate any and all contracts for default at any time in whole or in part, if the contractor fails to perform any of the provisions of any contract, so fails to pursue the work as to endanger performance in accordance with the terms of the IFB or any resulting contracts, and after receipt of written notice from SAHA, fails to correct such failures within seven (7) days or such other period as SAHA may authorize or require.

11.14.2.1.1 Upon receipt of a notice of termination issued from SAHA, the Contractor shall immediately cease all activities under any contract resulting from this IFB, unless expressly directed otherwise by SAHA in the notice of termination.

11.14.2.1.2 SAHA may terminate any contract resulting from this IFB in whole or in part, if funding is reduced, or is not obtained and continued at levels sufficient to allow for the expenditure.

11.14.3 Termination for Convenience: In the sole discretion of the Contracting Officer, SAHA may terminate any and all contracts resulting from this IFB in whole or part upon thirty days prior notice to the Contractor when it is determined to be in the best interest of SAHA.

11.14.4 The rights and remedies of SAHA provided under this section are not exclusive and are in addition to any other rights and remedies provided by law or under any contract.

11.14.5 In the event the resulting contract from this IFB is terminated for any reason, or upon its expiration, SAHA shall retain ownership of all work products including deliverables, source and object code, microcode, software licenses, and documentation in whatever form that may exist. In addition to any other provision, the Contractor shall transfer title and deliver to SAHA any partially completed work products, deliverables, source and object code, or documentation that the Contractor has produced or acquired in the performance of any resulting contract.

11.15 Examination and Retention of Contractor's Records: SAHA, HUD, or Comptroller General of the United States, or any of their duly authorized representatives shall, until three years after final payment under all contracts executed as a result of this IFB, have access to and the right to examine any of the Contractor's directly pertinent books, documents, papers, or other records involving transactions related to this contract for the purpose of making audits, examinations, excerpts and transcriptions.

11.16 Inter-local Participation

11.16.1 SAHA may from time to time enter into Inter-local Cooperation Purchasing Agreements with other governmental entities or governmental cooperatives (hereafter collectively referred to as "Entity" or "Entities") to enhance SAHA's purchasing power. At SAHA's sole discretion and option, SAHA may inform other Entities that they may acquire items listed in this IFB. Such acquisition(s) shall be at the prices stated herein, and shall be subject to Contractor's acceptance.

11.16.2 In no event shall SAHA be considered a dealer, remarketer, agent or other representative of Contractor or Entity. Further, SAHA shall not be considered and is not an agent; partner or representative of the Entity making purchases hereunder, and shall not be obligated or liable for any such order.

11.16.3 Purchase orders shall be submitted to Contractor by the individual Entity.

11.16.4 SAHA shall not be liable or responsible for any obligation, including but not limited to, payment and for any item or service ordered by an Entity, other than SAHA.

11.17 Right to data and Patent Rights: In addition to other ownership & use rights SAHA shall have exclusive ownership of all, proprietary interest in, and the right to full and exclusive possession of all information, materials, documents, software, and all electronic data discovered or produced by Contractor and/or subcontractor(s) pursuant to the terms of any resulting contract, including but not limited to, reports, memoranda or letters concerning the research and reporting tasks of any resulting contract. Both parties agree to comply with HUD Bulletin 909-23, which is the Notice of Assistance Regarding Patent and Copyright Infringement.

11.18 Lobbying Certification: By proposing to do business with SAHA or by doing business with SAHA, each Bidder certifies the following:

11.18.1 No Federal appropriated funds have been paid or will be paid, by or on behalf of the Bidder, to any person for influencing or attempting to influence an officer or employee of Congress, or an employee of a Member of Congress, an officer or employee of Congress, or an employee of a Member of Congress in connection with the awarding of any Federal contract, the making of any Federal grant, the making of any Federal loan, the entering into any cooperative agreement, and the extension, continuation, renewal, amendment or modification of any Federal contract, grant, loan or cooperative agreement.

11.18.2 If any funds other than Federally appropriated funds have been paid or will be paid to any person for influencing or attempting to influence an officer or employee of any agency, a Member of Congress, an officer or employee of Congress, or an employee of a Member of Congress in connection with this Federal contract, grant, loan, or cooperative agreement, the undersigned shall complete and submit Standard Form "Disclosure Form to Report Lobbying", in accordance with its instructions (See Attachment B).

11.18.3 The successful Bidder shall require that the language of this certification be included in the award documents for all sub-awards at all tiers, (including but not limited to subcontractors, sub-grants, and contracts under grants, loans, and cooperative agreements) and that all sub-recipients shall certify and disclose accordingly.

11.18.4 This clause is a material representation of fact upon which reliance will be placed when the award is made or a contract is entered into. The signing of a contract or acceptance of award certifies compliance with this certification, which is a prerequisite for making or entering into a contract, which is imposed by Section 1352, Title 31, U.S. Code. Any person who fails to file the required certifications shall be subject to civil penalty of not less than \$10,000.00 and not more than \$100,000.00 for each such failure.

11.19 Applicable Statutes, Regulations & Orders: Contractors shall comply with all statutes, rules, regulations, executive orders affecting procurements by Housing Authorities including but not limited to:

- 11.19.1 Executive Order 11246
- 11.19.2 Executive Order 11063
- 11.19.3 Copeland “Anti-Kickback” Act (18 USC 874)
- 11.19.4 Davis Bacon Act (40 USC 276a-276a-7)
- 11.19.5 Clean Air & Water Acts (42 USC 1857(h); 33 USC 1368)
- 11.19.6 Contract Work Hours & Safety Standards Act (40 USC 327-330)
- 11.19.7 Energy Policy & Conservation Act (PL 94-163, 89 STAT 871)
- 11.19.8 Civil Rights Act of 1964, Title VI (PL 88-352)
- 11.19.9 Civil Rights Act of 1968, Title VIII (PL 90-284 Fair Housing Act)
- 11.19.10 Age Discrimination Act of 1975
- 11.19.11 Anti-Drug Abuse Act of 1988 (42 USC 11901 et. Seq.)
- 11.19.12 HUD Information Bulletin 909-23
- 11.19.13 Immigration Reform & Control Act of 1986
- 11.19.14 Fair Labor Standards Act (29 USC 201, et. Seq.)

11.21 Additional Information: Each provision of law and each clause, which is required by law to be inserted in this IFB or any contract, shall be deemed to have been inserted herein, and this IFB and any resulting contract shall be read and enforced as though such provision or clause had been physically inserted herein. If, through mistake or otherwise, any such provision is not inserted or is inserted incorrectly, this agreement shall forthwith be physically amended to make such insertion or correction upon the application of either party. The fore-mentioned statutes, regulations and executive orders are not intended as an indication that such statute, regulation or executive order is necessary applicable nor is an omission of such statute, regulation or executive order intended to indicate that it is not applicable.

11.22 Conflicting Conditions: In the event there is a conflict between the documents comprising this IFB and any resulting contracts, the following order of precedence shall govern: (1) the more restrictive terms of either: any and all attached HUD forms and the term/conditions in the body of any resulting contract; (2) the IFB; and (3) Contractor’s Response. In the event that a conflict exists between any state statute or federal law the most restrictive terms shall apply.

11.23 Contract Form: SAHA will not execute a contract on the successful Bidder’s form. Contracts will only be executed on SAHA’s form. By submitting a bid, the successful Bidder agrees to this condition. However, SAHA will consider any contract clauses that the Bidder wishes to include therein, but the failure of SAHA to include such clauses does not give the successful Bidder the right to refuse to execute SAHA’s contract form. It is the responsibility of each prospective Bidder to notify SAHA, in writing, with the bid submittal of any contract clauses that he/she is not willing to include in the final executed contract. SAHA will consider such clauses and determine whether or not to amend the Contract.

- 11.24 Force Majeure:** Neither SAHA nor Contractor shall be held responsible for delays or default caused by fire, flood, riot, acts of God or war where such cause was beyond, respectively, SAHA or Contractor's reasonable control. Contractor shall make all reasonable efforts to remove or eliminate such a cause of delay or default and shall, upon the cessation of the cause, diligently pursue performance of its obligations under this Agreement.
- 11.25 Non-Boycott of Israel:** Texas prohibits a governmental entity from doing business with any vendor for goods or services unless that vendor verifies in the contract that "they i) do not boycott Israel and ii) will not boycott Israel during the term of the contract".
- 11.26 TX Gov. Code 2252.152:** Prohibits a government entity from awarding a contract to a company identified as Iran, Sudan, or a Foreign Terrorist Organization as identified on a list maintained by the Texas Comptroller of Public Accounts.

ATTACHMENT A Specifications

NOTE:

If there are any conflicts between the Terms and Conditions in the following specifications and the Terms and Conditions of the SAHA and/or HUD Forms the Terms and Conditions of the SAHA and/or HUD forms will prevail unless specifically noted otherwise.

SAN ANTONIO HOUSING AUTHORITY
 1900 Montana, Annex D, San Antonio, TX
 78203
 P: 210.477.6534

CONTACT: MARVIN WILLIAMS
 EMAIL: MARVIN_WILLIAMS@SAHA.ORG

ARCHITECT

SPRINKLE & CO. ARCHITECTS
 506 BROOKLYN
 P: 210.227.7722

CONTACT: DAVIS SPRINKLE, AIA
 EMAIL: CORBIN@SPRINKLECO.COM

STRUCTURAL ENGINEER

ACCUTECH CONSULTANTS
 909 NORTHEAST LOOP 410, SUITE 900
 P: 210.930.5355
 F: 210.930.5460

CONTACT: HENRY MARTINEZ
 EMAIL: HMARTINEZ@ACCUTECHUSA.NET

MEP ENGINEER

HM3 ENGINEERING

2902 NORTH FLORES
 P: 210.393.1840

CONTACT: ALFRED HERNANDEZ
 EMAIL: ALFRED@HM3ENGINEERING.COM

CODE SUMMARY

APPLICABLE BUILDING CODES	2015 INTERNATIONAL BUILDING CODE 2015 INTERNATIONAL FIRE CODE 2015 INTERNATIONAL MECHANICAL CODE 2015 INTERNATIONAL PLUMBING CODE 2014 NATIONAL ELECTRIC CODE																											
BUILDING AREAS	<table border="1"> <tr> <td></td> <td>1</td> <td>2</td> </tr> <tr> <td>UNIT 103</td> <td>798 SF</td> <td>798 SF</td> </tr> <tr> <td>UNIT 2404</td> <td>798 SF</td> <td>798 SF</td> </tr> <tr> <td>UNIT 1523</td> <td>944 SF</td> <td>944 SF</td> </tr> <tr> <td>UNIT 3023</td> <td>944 SF</td> <td>944 SF</td> </tr> <tr> <td>UNIT 1501</td> <td>1293 SF</td> <td>1293 SF</td> </tr> <tr> <td>UNIT 942</td> <td>929 SF</td> <td></td> </tr> <tr> <td>UNIT 1818</td> <td>1205 SF</td> <td>1205 SF</td> </tr> <tr> <td>OVERALL:</td> <td>6935 SF</td> <td>6005 SF = 12940SF</td> </tr> </table>		1	2	UNIT 103	798 SF	798 SF	UNIT 2404	798 SF	798 SF	UNIT 1523	944 SF	944 SF	UNIT 3023	944 SF	944 SF	UNIT 1501	1293 SF	1293 SF	UNIT 942	929 SF		UNIT 1818	1205 SF	1205 SF	OVERALL:	6935 SF	6005 SF = 12940SF
	1	2																										
UNIT 103	798 SF	798 SF																										
UNIT 2404	798 SF	798 SF																										
UNIT 1523	944 SF	944 SF																										
UNIT 3023	944 SF	944 SF																										
UNIT 1501	1293 SF	1293 SF																										
UNIT 942	929 SF																											
UNIT 1818	1205 SF	1205 SF																										
OVERALL:	6935 SF	6005 SF = 12940SF																										
OCCUPANCY CLASSIFICATION	RESIDENTIAL – GROUP R-2																											
CONSTRUCTION TYPE	TYPE 5-A																											

SCOPE OF WORK:

PROJECT CONSIST OF INTERIOR REMODEL FOR SEVEN (7) MULTI-FAMILY RESIDENTIAL UNITS FOR S.A.H.A. THE EXISTING UNITS ARE CURRENTLY VACANT DUE TO FIRE OR WATER DAMAGE. INTERIOR DEMOLITION HAS BEEN PERFORMED UNDER A SEPARATE PERMIT, NO STRUCTURAL MEMBERS HAVE BEEN REMOVED.

ALL SEVEN (7) UNITS WILL REMODELED AND READY TO MOVE IN. ALL DAMAGED WOOD JOISTS AND STUDS WILL BE REPLACED WITH NEW WOOD JOISTS AND STUDS AS SCHEDULED BY THE STRUCTURAL ENGINEER. THE EXISTING WOOD STUDS SHALL BE RECEIVING NEW GYPSUM BOARD, TEXTURED & PAINTED. ALL UNITS ARE SCHEDULED TO HAVE NEW MECHANICAL, ELECTRICAL, & PLUMBING IMPROVEMENTS AS SCHEDULED ON PLANS. THE EXTERIOR FINISH MODIFICATIONS CONSIST OF NEW ROOFING, SHEATHING WHERE APPLICABLE, 8.25 CEMENTITIOUS SIDING WITH SMOOTH FINISH, AND REPLACING EXISTING VENEER BRICK WITH NEW BRICK TO MATCH EXISTING AS SPELLED OUT IN DRAWINGS.

THE SCOPE OF WORK IS A GENERAL BRIEF DESCRIPTION. THE GENERAL CONTRACTOR SHALL PROVIDE ALL OF THE CONSTRUCTION AS DESCRIBED IN THE DRAWINGS AND SPECIFICATIONS.

- A3 1501 SAN CARLOS TYPE 'E' – 1ST & 2ND FLOOR PLAN / INT. & EXT. ELEVATIONS
- A4 MERIDA 942 TYPE '1A' – 1ST FLOOR PLAN / INT. & EXT. ELEVATIONS
- A5 KROCKER 1818 TYPE 'A2' – 1ST & 2ND FLOOR PLANS / INT. & EXT. ELEVATIONS
- A6 SCHEDULES AND CABINET SECTIONS
- A7 DETAILS
- A8 WINDOW, DOOR AND SCHEDULES, DETAILS STRUCTURAL
- S1 FRAMING PLANS – UNITS 1818 & 942
- S2 FRAMING PLANS – UNITS 103, 1523, & 1501
- S3 FRAMING PLANS – UNITS 2404 & 3023
- S4 GENERAL NOTES

MECHANICAL

- M0.0 MECHANICAL SYMBOLS AND ABBREVIATIONS
- M2.0 MECHANICAL 1ST FLOOR PLAN – UNIT 942
- M2.1 MECH. 1ST & 2ND FLOOR PLAN I UNIT 1818
- M2.2 MECH. PLAN 1ST & 2ND FLR PLAN – UNIT 103 & 2404
- M2.3 MECH. PLAN 1ST & 2ND FLR PLAN – UNIT 1523 & 3023
- M2.4 MECH. PLAN 1ST & 2ND FLR PLAN – UNIT 1501
- M4.0 MECHANICAL DETAILS AND SCHEDULES

ELECTRICAL

- E0.0 ELECTRICAL SYMBOLS AND ABBREVIATIONS
- E2.0 LIGHTING PLAN – UNIT 942
- E2.1 LIGHTING PLAN – UNIT 1818
- E2.2 LIGHTING PLAN – UNIT 103 & 2404
- E2.3 LIGHTING PLAN – UNIT 1523 & 3023
- E2.4 LIGHTING PLAN – UNIT 1501
- E3.0 POWER PLAN – UNIT 942
- E3.1 POWER PLAN – UNIT 1818
- E3.2 POWER PLAN – UNIT 103 & 2404
- E3.3 POWER PLAN – UNIT 1523 & 3023
- E3.4 POWER PLAN – UNIT 1501
- E4.0 ELECTRICAL SCHEDULES
- E5.0 ELECTRICAL SCHEDULES AND RISER
- E6.0 ELECTRICAL DETAILS

PLUMBING

- P0.0 PLUMBING SYMBOLS AND ABBREVIATIONS
- P2.0 PLUMBING PLAN – UNIT 942
- P2.1 PLUMBING PLAN – UNIT 1818
- P2.2 PLUMBING PLAN – UNIT 103 & 2404
- P2.3 PLUMBING PLAN – UNIT 1523 & 3023
- P2.4 PLUMBING PLAN – UNIT 1501
- P3.0 PLUMBING SCHEDULES & DETAILS

ARCHITECTURAL SYMBOL LEGEND

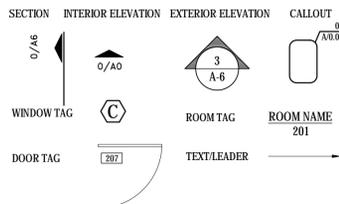

17. CLEAR WHERE A SPECIFIC DETAIL CONTRACTOR'S RESPONSIBILITY T

19. MATERIALS USED FOR NEW CONCRETE ARE UNAVAILABLE THE CONTRACTOR SHALL BE RESPONSIBLE FOR SURFACES AS SPECIFIED BY ARCHITECT'S PERFORMANCE CAPABILITIES OWNER.

20. GENERAL CONTRACTOR SHALL BE RESPONSIBLE FOR COORDINATION BETWEEN SUBCONTRACTORS INCLUDING EXISTING WORK TO BE REMOVED SHALL BE INCLUDED IN THE BASE PRICE.

21. GENERAL CONTRACTOR SHALL BE RESPONSIBLE FOR VALUABLE MATERIALS AND UNAVAILABLE MATERIALS NOT RESPONSIBLE FOR ANY DAMAGE TO THE PROJECT.

DEMOLITION NOTE

1. REMOVE ALL INTERIOR MILLWORK
2. REMOVE HOT WATER HEATER, DUCTWORK
3. REMOVE ALL INTERIOR DOORS & PARTITIONS
4. ALL WINDOWS ARE TO BE REMOVED
5. REMOVE ALL DAMAGED WOOD SILLING
6. REMOVE AND REPLACE EXISTING ROOFING
7. REMOVE ALL SOFFIT & FASCIA MATERIAL
8. REMOVE ALL EXISTING ROOF SHEATHING
9. ALL EXISTING INTERIOR FRAMING TO REMAIN
10. THESE NOTES ARE TO BE USED IN CONJUNCTION WITH THE DRAWINGS AND SPECIFICATIONS.

11. PROVIDE AND MAINTAIN INTERIOR STABILITY AND TO PREVENT COLLAPSE OF STRUCTURE DURING SELECTIVE DEMOLITION.

12. REMOVE, REPLACE, PATCH AND REPAIR DAMAGED DURING SELECTIVE DEMOLITION TO MAINTAIN QUALITY AS SPECIFIED BY ARCHITECT.

13. SURVEY EXISTING CONDITIONS AND RECORD ALL CONSTRUCTION DOCUMENTS TO DETERMINE EXISTING CONDITIONS.

14. THE CONTRACTOR WILL SURVEY AND RECORD ALL DEMOLITION ACTIVITIES.

15. LOCATE, IDENTIFY, DISCONNECT, DEMOLISH, RELOCATE OR REPAIR ALL UTILITIES SHUT OFF OF UTILITIES CONNECTIONS TO MAINTAIN SERVICE.

16. CLEAN ADJACENT STRUCTURES, EXTERIOR AND DEBRIS CAUSED BY DEMOLITION EXISTING PRIOR TO THE START OF CONSTRUCTION.

17. GENERAL CONTRACTOR IS RESPONSIBLE FOR WALLS, & CONCRETE WALKS, BALCONIES, & TERRACES.

18. GENERAL CONTRACTOR SHALL NOT OBSTRUCTING FIRE LANES OR FIRE ESCAPE ROUTES.

19. GENERAL CONTRACTOR IS TO COORDINATE WITH ALL OTHER TRADES TO COMPLETE ALL WORK.

20. IF THERE ARE ANY DISCREPANCIES BETWEEN THE DRAWINGS AND SPECIFICATIONS, THE CONTRACTOR SHALL PREVAIL.

21. ANY DAMAGES TO EXISTING FACILITIES SHALL BE REPAIRED TO ORIGINAL CONDITION AT THE G.C.'S LACK OF COORDINATION & NOT BE CONSIDERED AS A BASIS FOR CLAIMS.

22. GENERAL CONTRACTOR SHALL COORDINATE ALL WORK TO BE COMPLETED BY OTHER TRADES TO BE COMPLETED BY THE G.C.'S LACK OF COORDINATION & NOT BE CONSIDERED AS A BASIS FOR CLAIMS.

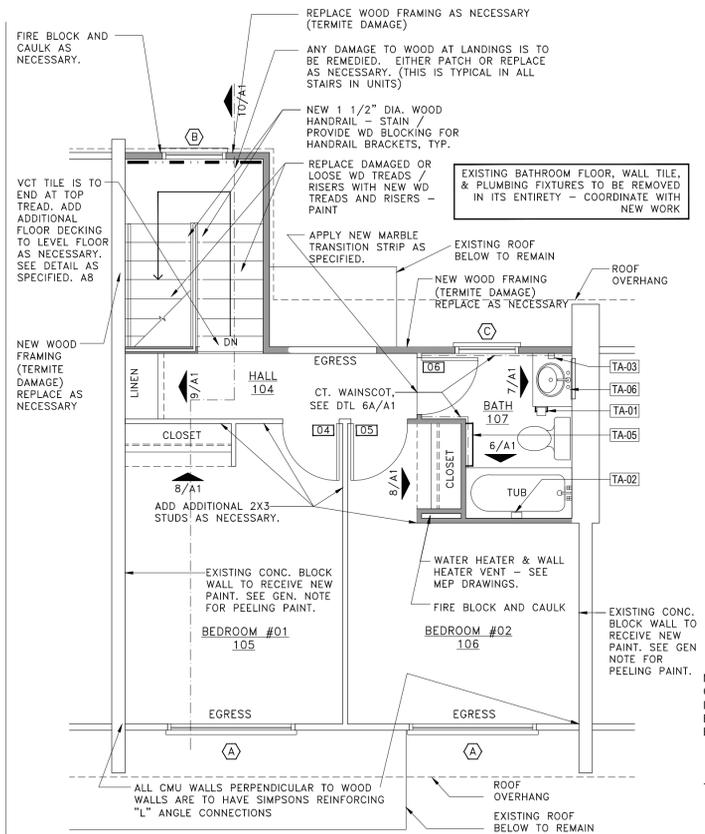

2 SECOND FLOOR PLAN - UNIT 103 & UNIT 2404
1/4" = 1'-0"

ALL WINDOWS ARE TO BE REPLACED INCLUDING THE FRAME. IMPLEMENTATION OF NEW SPECIFIED WINDOWS TO BE INSTALLED WITH NEW WINDOW FRAME AND VAPOR BARRIER. SEVERELY DAMAGED WINDOWS & WINDOW FRAMES TO BE REPLACED COMPLETELY WITH NEW SPECIFIED WINDOWS TO MATCH WINDOWS USED ELSEWHERE.

ALL WALL STUD SHOULD MATCH EXISTING WALL STUD. CONTRACTOR SHOULD TAKE THIS COST OF FABRICATING ANY MATERIAL INTO CONSIDERATION.

ALL UNITS ARE TO HAVE NEW HEATER VENT PIPE FLASHING AND WATERPROOFING TO AT ROOF LOCATION. INSTALL TO MANUFACTURER'S SPECIFICATIONS.

ALL UNITS ARE TO HAVE NEW HEAVY DUTY DOOR FRAMES INCLUDING 2X3 WALLS.

EACH INDIVIDUAL APARTMENT UNIT TO BE PROVIDED WITH ONE 2A, 10BC FIRE EXTINGUISHER. THE EXTINGUISHER IS TO BE MOUNTED INSIDE THE CABINET UNDER THE SINK IN THE KITCHEN.

THIS FLOOR PLAN PERTAINS TO UNIT 103 SAN LINO. UNIT 2404 IS A MIRROR IMAGE OF THIS FLOOR PLAN.

ALL EXISTING UNDAMAGED INTERIOR PARTITIONS ARE TO BE REUSED AND PROVIDED W/ NEW 5/8" GWB, PTD.

SECOND FLOOR FLOOR DECK TO BE REPLACED W/ NEW 3/4" PLYWOOD - REFER TO STRUCTURAL DRAWINGS.

ALL EXISTING WINDOWS/DOORS ARE TO BE REMOVED AND REPLACED W/ NEW - REFER TO SCHEDULE SHEET.

ALL EXTERIOR LIGHT FIXTURES AND BUILDING NUMBERS ARE TO BE REMOVED AND REPLACED.

RE-FLOAT FIRST FLOOR LEVEL INTERIOR FLOOR AS NECESSARY TO ACCOMMODATE NEW FLOORING FINISH.

LEGEND:

EXISTING
NEW
DEMO
ACCENT WALL PAINT

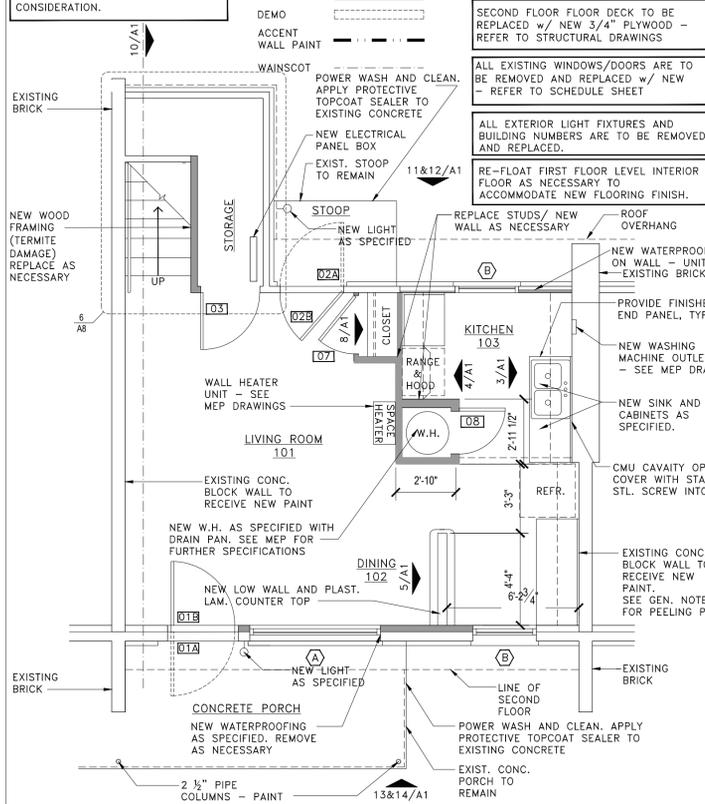

1 GROUND FLOOR PLAN - UNIT 103 & UNIT 2404
1/4" = 1'-0"

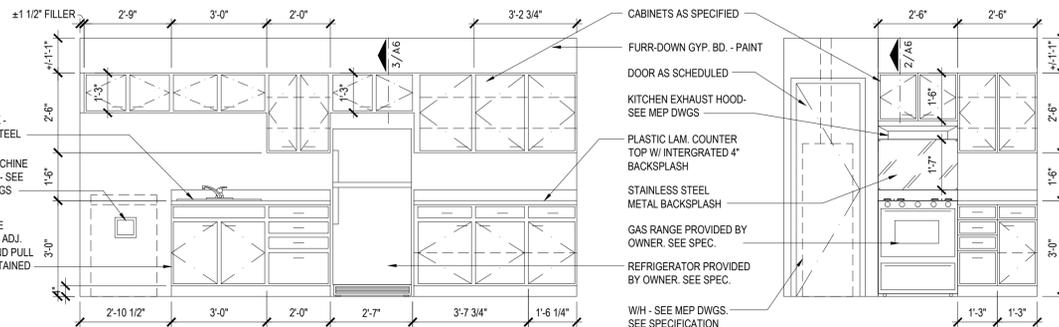

3 KITCHEN ELEV - UNITS 103 & 2404
3/8" = 1'-0"

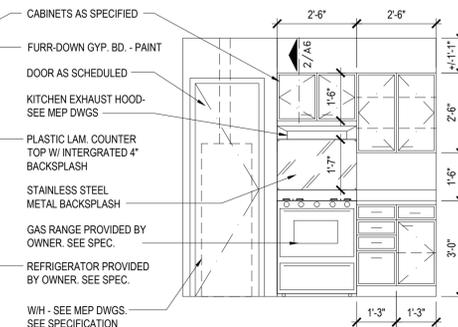

4 KITCHEN ELEV - UNITS 103 & 2404
3/8" = 1'-0"

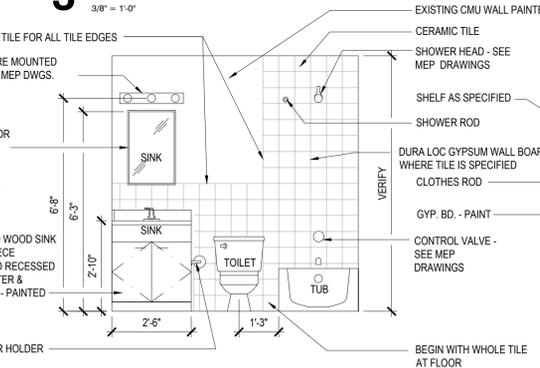

7 BATHROOM ELEV - UNITS 103 & 2404
3/8" = 1'-0"

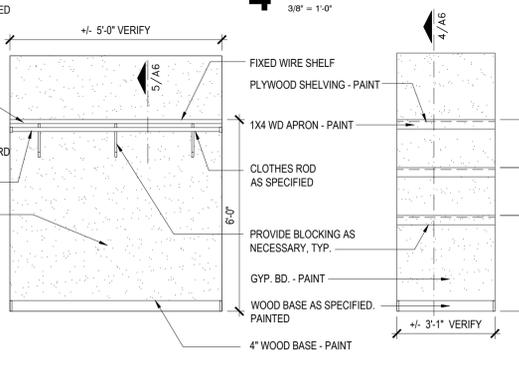

8 TYP. CLOSET SHELF ELEVATION
3/8" = 1'-0"

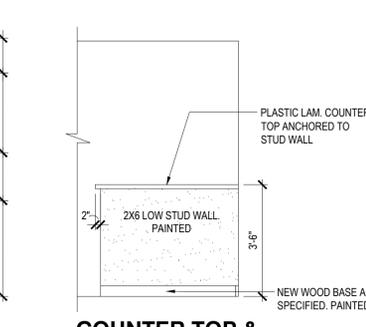

5 COUNTER TOP & LOW WALL ELEV - UNITS 103 & 2404
3/8" = 1'-0"

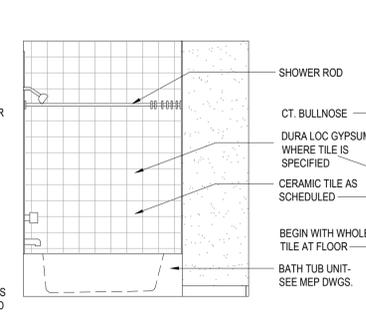

6 BATHROOM ELEV - UNITS 103 & 2404
3/8" = 1'-0"

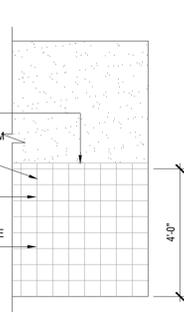

6A CERAMIC TILE WAINSCOT
3/8" = 1'-0"

REPLACE ALL PLUMBING VALVES AS SPECIFIED.

ALL PLUMBING UNDER LAVATORIES, SINKS, AND FAUCETS SHALL BE BRASS AND CHROME FINISH IN LIEU OF PVC.

ALL BATHROOM ACCESSORIES, TOILET, TUB, SINK AND FIXTURES - PROVIDE EXTRA BLOCKING.

GENERAL CONTRACTOR SHALL PERFORM A PLUMBING DRAIN TEST FOR EXISTING LINES AND BE SURE ALL LINES ARE PERFORMING ACCORDINGLY.

AT ALL WET LOCATIONS PROVIDE MOISTURE RESISTANT GYPSUM BOARD.

ALL FIRE DAMAGED STUDS, SHEATHING, SIDING AND WATERPROOFING IS TO BE REPLACED WITH NEW STUDS, WATERPROOFING, SIDING AND SHEATHING AS SPECIFIED.

CONTRACTOR IS TO POWER WASH ALL BRICK AS NECESSARY BEFORE PRIMER AND PAINT.

ALL UNITS WILL HAVE NEW SMOKE DETECTORS IN ALL BEDROOMS AND LIVING ROOMS.

ALL EXTERIOR MATERIALS ARE TO MATCH EXISTING MATERIALS. ANY DEVIATIONS ARE TO BE APPROVED BY THE ARCHITECT.

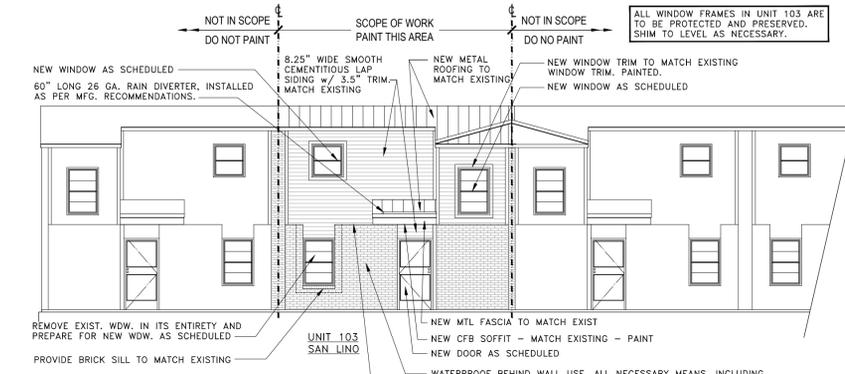

11 REAR ELEVATION - UNIT 103
1/8" = 1'-0"

ALL WINDOW FRAMES IN UNIT 103 ARE TO BE PROTECTED AND PRESERVED. SHIM TO LEVEL AS NECESSARY.

ALL UNITS ARE TO HAVE NEW MAILBOXES AND EXTERIOR LIGHT FIXTURES, INCLUDING WALL PACKS WITH DUSK TILL DAWN SENSORS.

ALL FIRE DAMAGED UNITS ARE TO BE PROPERLY CLEANED, SEALED AND SPRAYED WITH 2 COATS OF KILZ TO ELIMINATED FIRE DAMAGE ODOR.

ALL WINDOWS ARE TO HAVE NEW INT./EXT. WINDOW TRIM AS NECESSARY.

ALL UNITS ARE TO HAVE NEW CABLE AND DATA LINES. CABLE AND DATA IS TO BE INSTALLED IN EVERY BEDROOM AND LIVING ROOM.

REMOVE ALL EXISTING SIDING. PROVIDE NEW 8.25" WIDE SMOOTH CEMENTITIOUS LAP SIDING W/ 3.5" TRIM. EXISTING MASONRY AND REPLACE DAMAGED SHEATHING & VAPOR BARRIER W/ NEW SHEATHING & VAPOR BARRIER SEE STRUCTURAL DRAWINGS.

ALL EXISTING WINDOWS/ EXTERIOR DOORS ARE TO BE REMOVED AND REPLACED WITH NEW. NEW WINDOWS/DOORS TO MATCH EXISTING WINDOW STYLING.

SIDING IS TO MATCH EXISTING SIDING TEXTURE.

ALL UNITS ARE TO RECEIVE NEW GUTTERS AND DOWN SPOUTS AS NECESSARY. MATCH EXISTING. OWNER SPECIFIED.

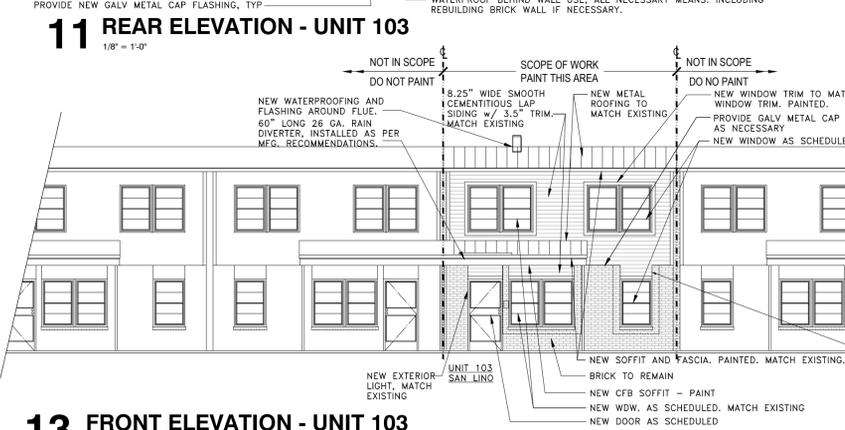

13 FRONT ELEVATION - UNIT 103
1/8" = 1'-0"

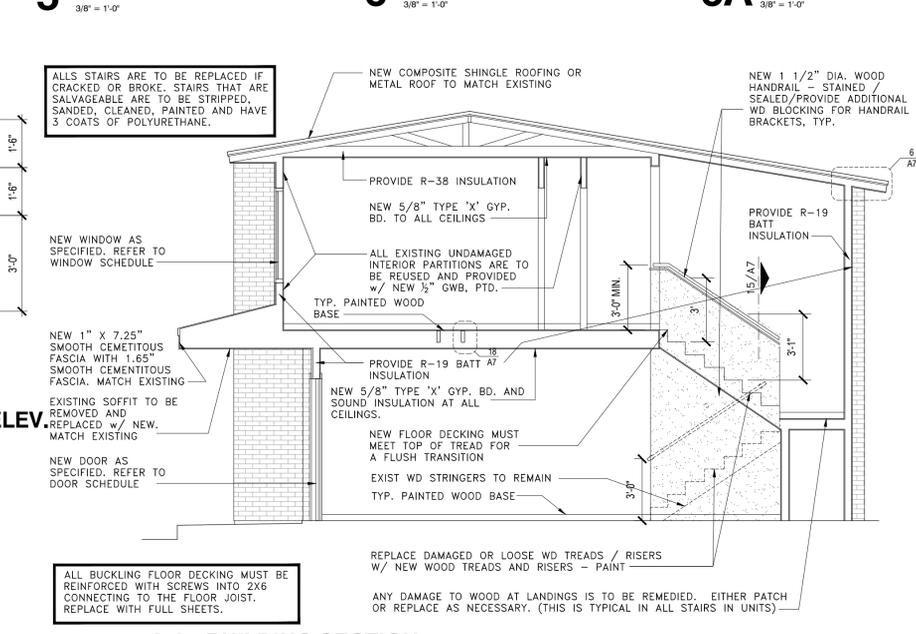

10 BUILDING SECTION
1/4" = 1'-0"

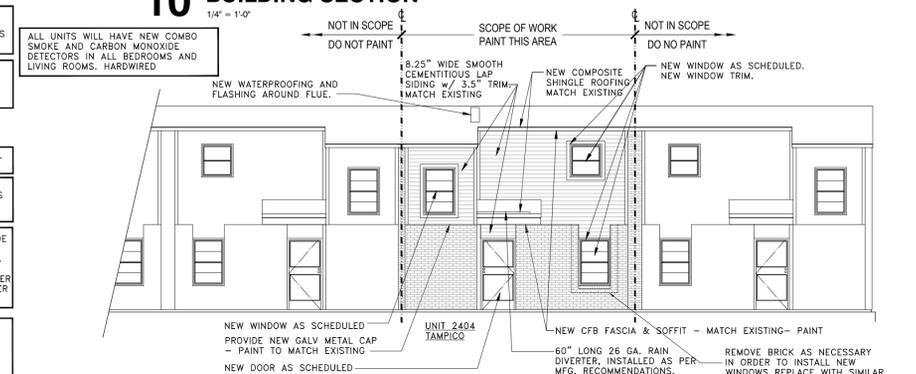

12 REAR ELEVATION - UNIT 2404
1/8" = 1'-0"

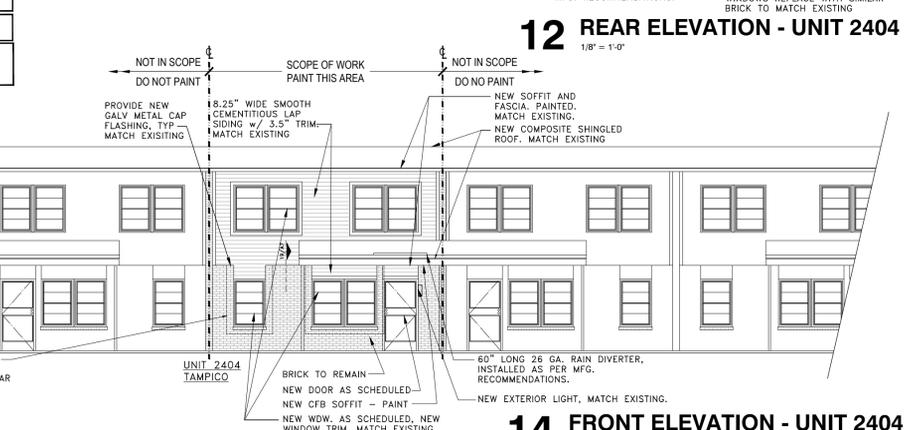

14 FRONT ELEVATION - UNIT 2404
1/8" = 1'-0"

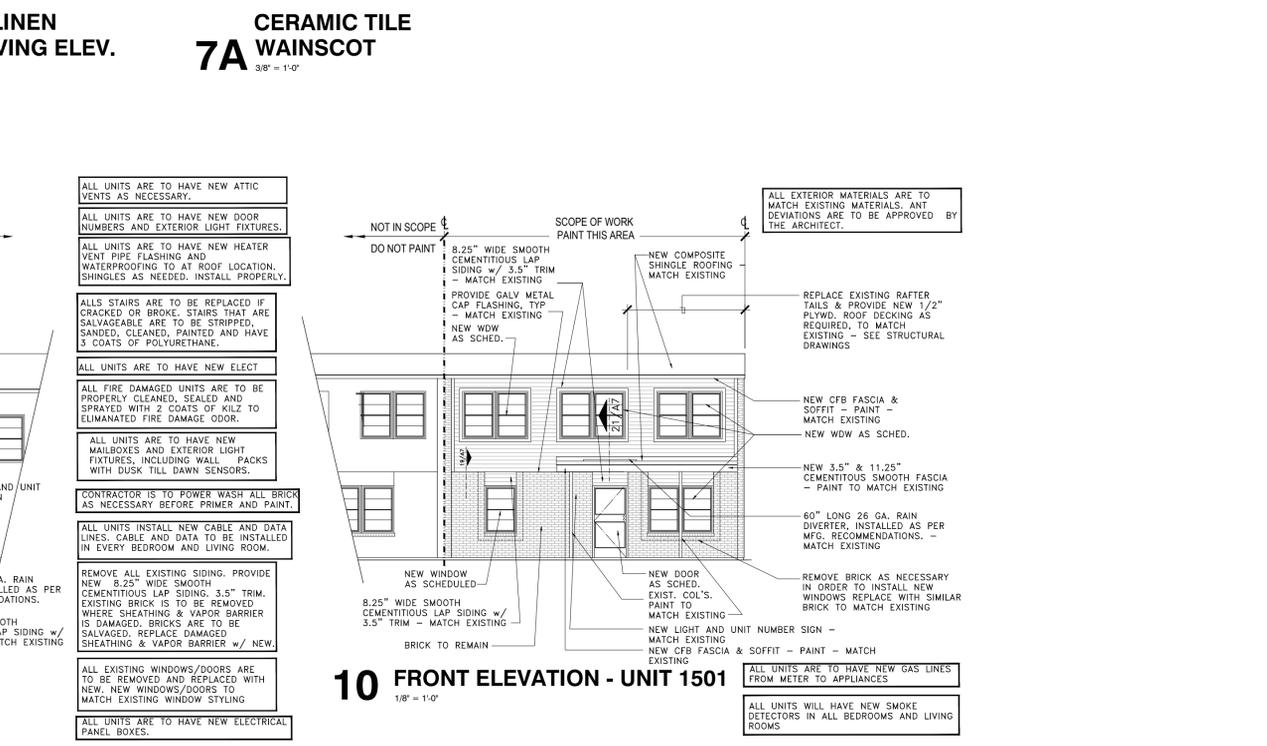
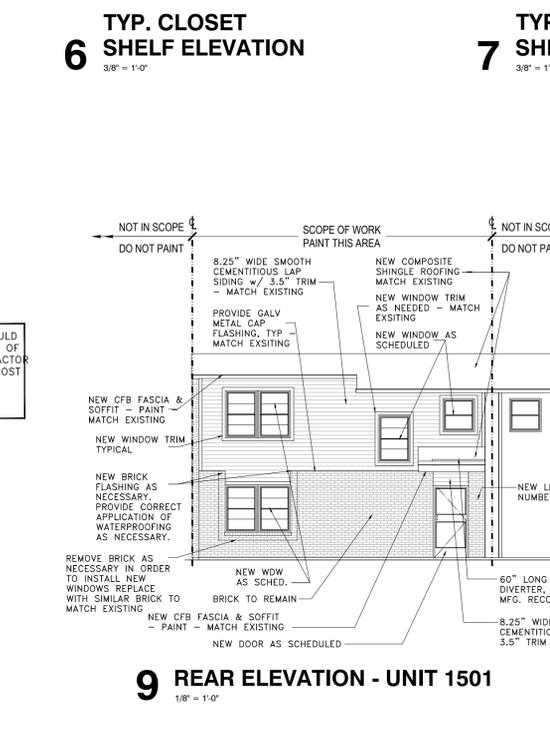
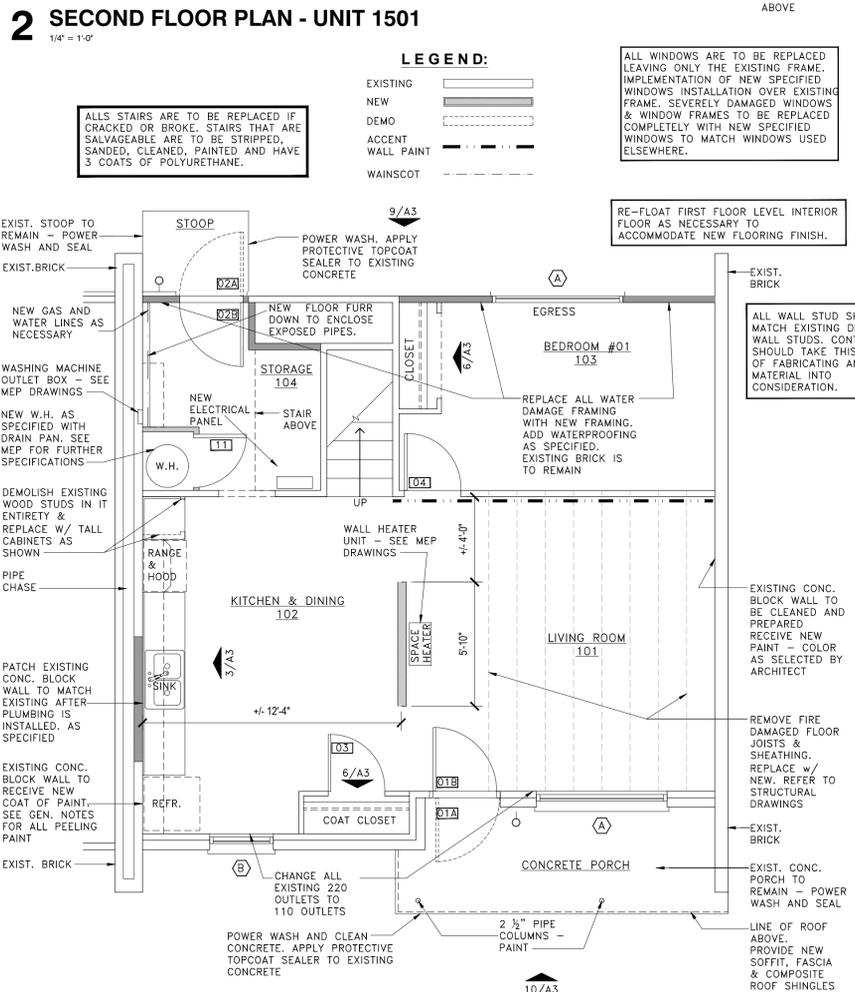
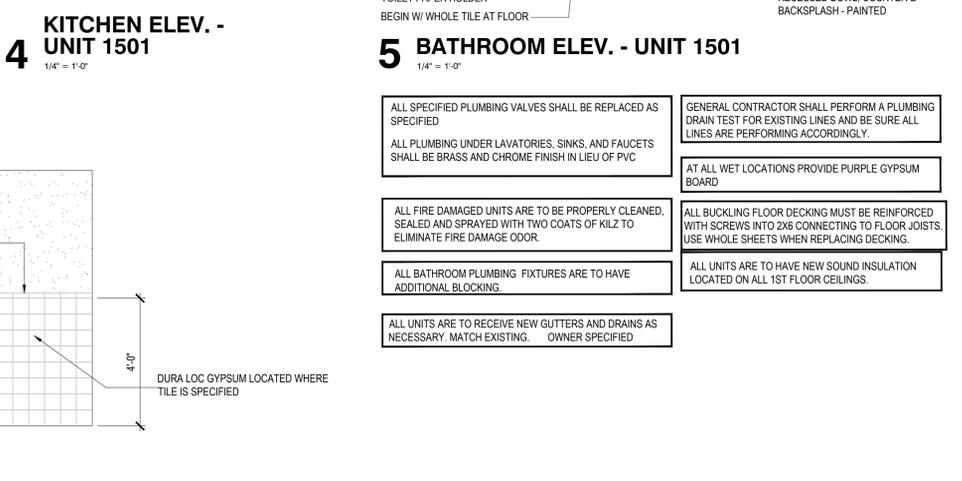
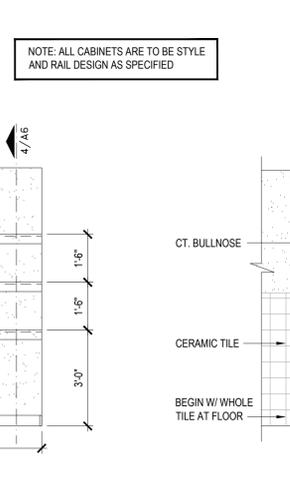
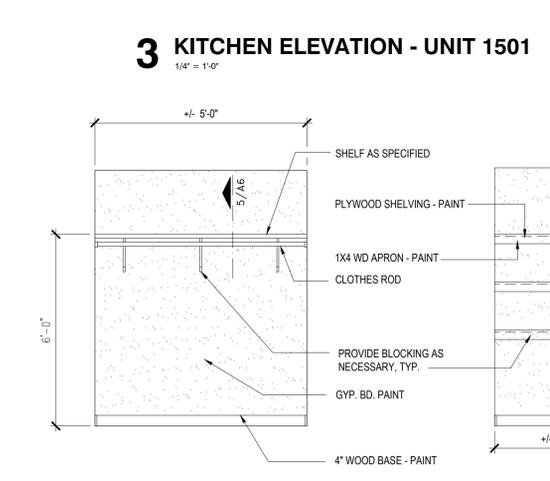
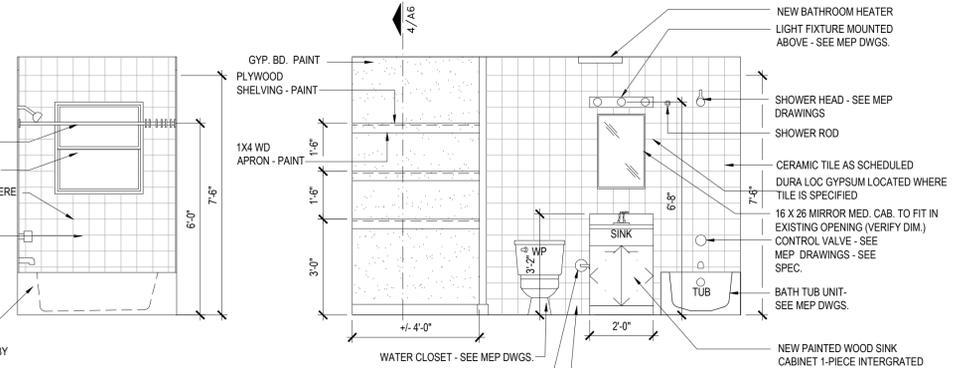
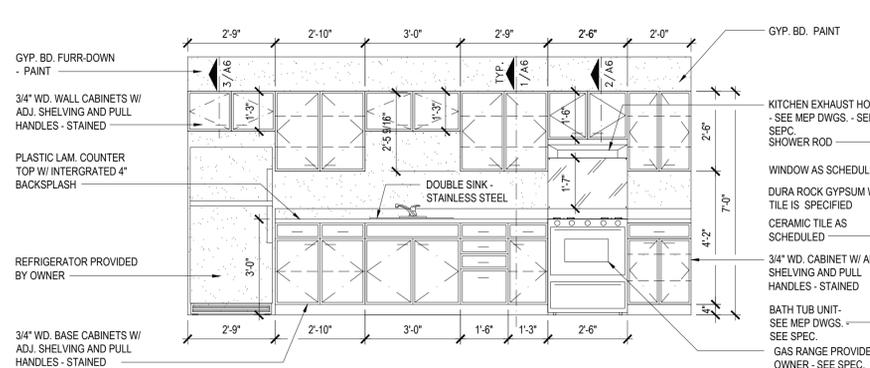
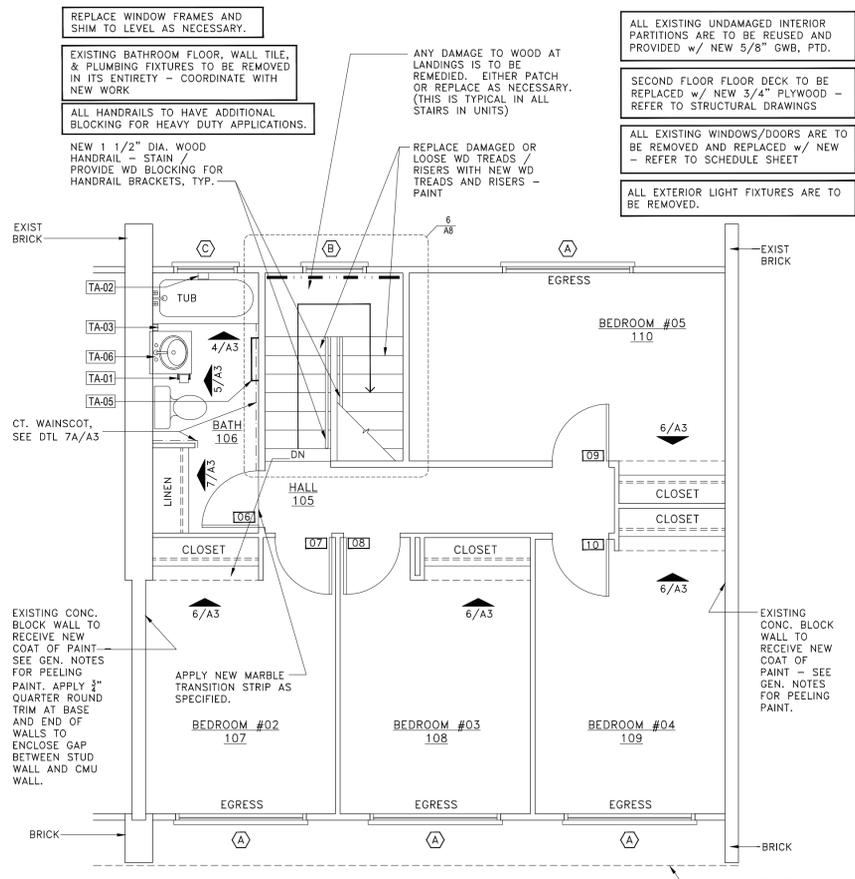

UNITS ARE TO HAVE NEW DATA AND CABLE LINES. CABLE AND DATA IS TO BE INSTALLED IN EVERY BEDROOM AND LIVING ROOM.

ALL EXTERIOR LIGHT FIXTURES ARE TO BE REMOVED AND REPLACED.

ALL WALL STUD SHOULD MATCH EXISTING WALL STUD. CONTRACTOR SHOULD TAKE THIS COST OF FABRICATING ANY MATERIAL INTO CONSIDERATION.

ALL WINDOWS ARE TO BE REPLACED LEAVING ONLY THE EXISTING FRAME. IMPLEMENTATION OF NEW SPECIFIED WINDOWS INSTALLATION OVER EXISTING FRAME. SEVERELY DAMAGED WINDOWS & WINDOW FRAMES TO BE REPLACED COMPLETELY WITH NEW SPECIFIED WINDOWS TO MATCH WINDOWS USED ELSEWHERE.

EACH INDIVIDUAL APARTMENT UNIT TO BE PROVIDED WITH ONE 2A, 100LB FIRE EXTINGUISHER. THE EXTINGUISHER IS TO BE MOUNTED INSIDE THE CABINET UNDER THE SINK IN THE KITCHEN.

RE-FLOAT FIRST FLOOR LEVEL INTERIOR FLOOR AS NECESSARY TO ACCOMMODATE NEW FLOORING FINISH.

ALL UNITS ARE TO HAVE NEW HEATER VENT PIPE FLASHING AND WATERPROOFING TO AT ROOF LOCATION. INSTALL PER MANUFAC. RECOMMENDATIONS

REPLACE ALL FRAMING ELEMENTS AS NECESSARY. INCLUDING ALL SILL PLATES AND HEAD PLATES.

REPLACE ALL FRAMING ELEMENTS DAMAGED BY TERMITES. ADD TEMPORARY SHORING AS NECESSARY.

ALL EXISTING UNDAUNTED INTERIOR PARTITIONS ARE TO BE REUSED AND PROVIDED W/ NEW 1/2" GWB, PTD.

ALL EXISTING WINDOWS/DOORS ARE TO BE REMOVED AND REPLACED W/ NEW AS NECESSARY.

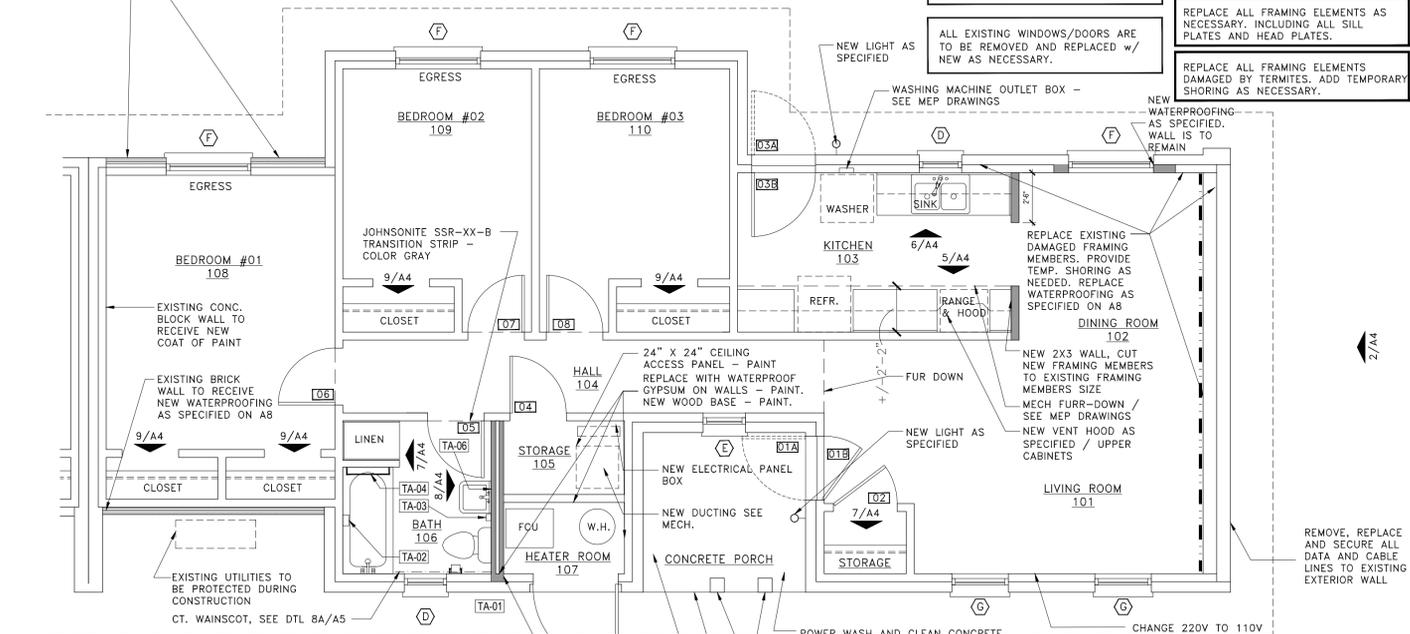

EXISTING BRICK TO REMAIN. WALL IS TO HAVE NEW WATERPROOFING AS SPECIFIED ON A8

EXISTING CONC. BLOCK WALL TO RECEIVE NEW COAT OF PAINT

EXISTING BRICK WALL TO RECEIVE NEW WATERPROOFING AS SPECIFIED ON A8

EXISTING UTILITIES TO BE PROTECTED DURING CONSTRUCTION CT. WAINSCOT, SEE DTL 8A/A5

ALL UNITS ARE TO HAVE NEW HEAVY DUTY DOOR FRAMES. FABRICATE AS NEED TO MATCH EXISTING STUDS

EXIST SECURITY MTL DOOR / SAND AND PREPARE FOR NEW PAINT

EXISTING BATHROOM FLOOR, WALL TILE & PLUMBING FIXTURES TO BE REMOVED IN ITS ENTIRETY - COORDINATE WITH NEW WORK

LEGEND:

- EXISTING
- NEW
- DEMO
- ACCENT WALL PAINT
- WAINSCOT

NEW LIGHT AS SPECIFIED

WASHING MACHINE OUTLET BOX - SEE MEP DRAWINGS

NEW WATERPROOFING AS SPECIFIED. WALL IS TO REMAIN

REPLACE EXISTING DAMAGED FRAMING MEMBERS. PROVIDE TEMP. SHORING AS NEEDED. REPLACE WATERPROOFING AS SPECIFIED ON A8

NEW 2X3 WALL, CUT NEW FRAMING MEMBERS TO EXISTING FRAMING MEMBERS SIZE

MECH FUR-DOWN / SEE MEP DRAWINGS

NEW VENT HOOD AS SPECIFIED / UPPER CABINETS

24" X 24" CEILING ACCESS PANEL - PAINT

REPLACE WITH WATERPROOF GYPSUM ON WALLS - PAINT. NEW WOOD BASE - PAINT.

FUR DOWN

NEW LIGHT AS SPECIFIED

NEW ELECTRICAL PANEL BOX

NEW DUCTING SEE MECH.

CONCRETE PORCH

POWER WASH AND CLEAN CONCRETE. APPLY PROTECTIVE TOPCOAT SEALER TO EXISTING CONCRETE

EXIST. BRICK COLUMNS TO REMAIN

EXIST. CONC. PORCH TO REMAIN

REMOVE EXISTING SOFFIT. REPLACE W/ NEW CFB - PAINT / PROVIDE CFB TRIM

REPLACE EXISTING MISSING FRAMING MEMBERS. FABRICATE TO MATCH EXISTING SIZE AS NECESSARY.

CONTRACTOR IS TO PROVIDE NEW CENTRAL HEAT AIR DUCTING

CHANGE 220V TO 110V

ROOF OVERHANG. EXISTING SOFFIT & FASCIA TO BE REMOVED AND REPLACE W/ NEW

REMOVE, REPLACE AND SECURE ALL DATA AND CABLE LINES TO EXISTING EXTERIOR WALL

EXIST. CONC. PORCH TO REMAIN

REMOVE EXISTING SOFFIT. REPLACE W/ NEW CFB - PAINT / PROVIDE CFB TRIM

REPLACE EXISTING MISSING FRAMING MEMBERS. FABRICATE TO MATCH EXISTING SIZE AS NECESSARY.

CONTRACTOR IS TO PROVIDE NEW CENTRAL HEAT AIR DUCTING

CHANGE 220V TO 110V

ROOF OVERHANG. EXISTING SOFFIT & FASCIA TO BE REMOVED AND REPLACE W/ NEW

NEW MAILBOX AND ADDRESS NUMBERS TO REPLACE EXISTING. MATCH EXISTING

PROTECT AND PRESERVE ALL WINDOW FRAMES AND SHIM TO LEVEL AS NECESSARY.

ALL UNITS ARE TO HAVE NEW HEAVY DUTY DOOR AND WINDOW FRAMES.

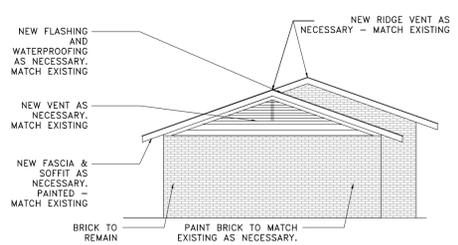

2 BACK ELEVATION - UNIT 942
1/8" = 1'-0"

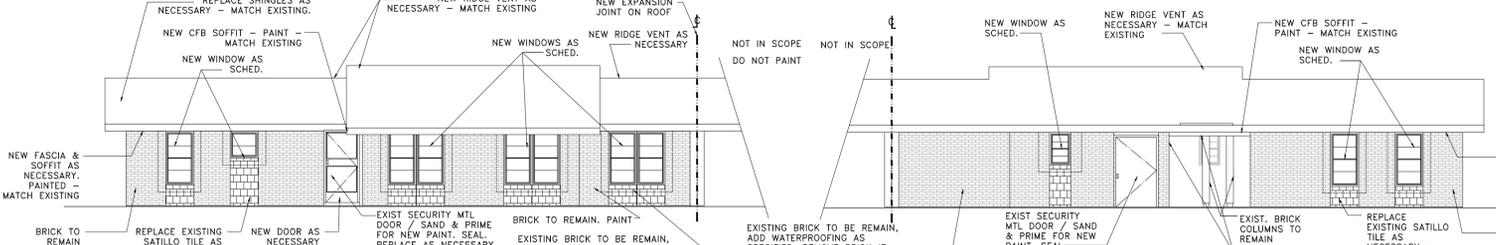

3 BACK ELEVATION - UNIT 942
1/8" = 1'-0"

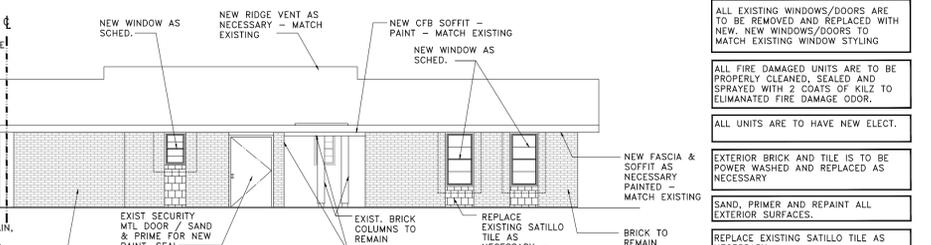

4 FRONT ELEVATION - UNIT 942
1/8" = 1'-0"

ALL EXISTING WINDOWS/DOORS ARE TO BE REMOVED AND REPLACED WITH NEW. NEW WINDOWS/DOORS TO MATCH EXISTING WINDOW STYLING

ALL FIRE DAMAGED UNITS ARE TO BE PROPERLY CLEANED, SEALED AND SPRAYED WITH 2 COATS OF KILZ TO ELIMINATE FIRE DAMAGE ODOR.

ALL UNITS ARE TO HAVE NEW ELECT.

EXTERIOR BRICK AND TILE IS TO BE POWER WASHED AND REPLACED AS NECESSARY

SAND, PRIMER AND REPAINT ALL EXTERIOR SURFACES.

REPLACE EXISTING SATILLO TILE AS NECESSARY.

ALL UNITS ARE TO RECEIVE NEW GUTTERS AND DRAINS AS NECESSARY. MATCH EXISTING. OWNER SPECIFIED

ALL UNITS WILL HAVE NEW SMOKE AND CARBON MONOXIDE DETECTORS IN ALL BEDROOMS AND LIVING ROOMS

ALL SPECIFIED PLUMBING VALVES SHALL BE REPLACED AS SPECIFIED

ALL PLUMBING UNDER LAVATORIES, SINKS, AND FAUCETS SHALL BE BRASS AND CHROME FINISH IN LIEU OF PVC

SIDING IS TO MATCH EXISTING SIDING TEXTURE.

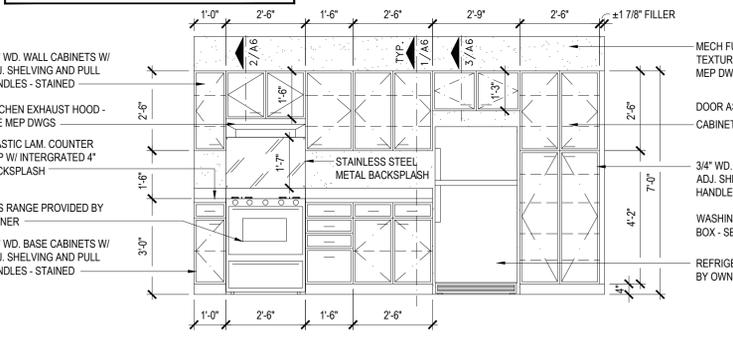

5 KITCHEN ELEVATION - UNIT 942
3/8" = 1'-0"

GENERAL CONTRACTOR SHALL PERFORM A PLUMBING DRAIN TEST FOR EXISTING LINES AND BE SURE ALL LINES ARE PERFORMING ACCORDINGLY.

AT ALL WET LOCATIONS PROVIDE PURPLE GYPSUM BOARD

DURA ROCK GYPSUM TILE IS LOCATED

4. ALL BATHROOM ACCESSORIES, TOILET, TUB, SINK AND FIXTURES - PROVIDE EXTRA BLOCKING

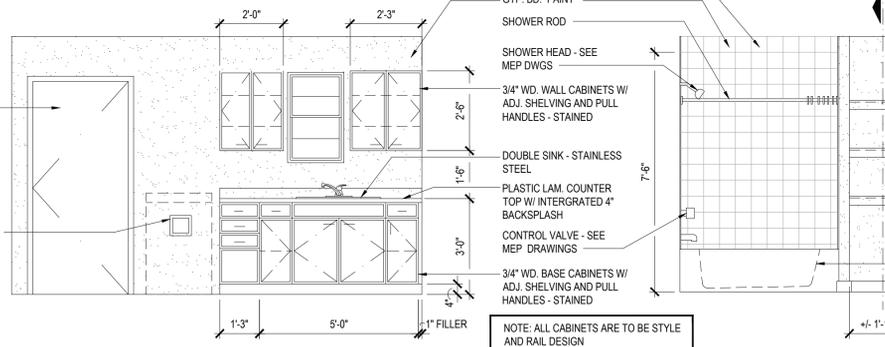

6 KITCHEN ELEV - UNIT 942
3/8" = 1'-0"

4. ALL BATHROOM ACCESSORIES, TOILET, TUB, SINK AND FIXTURES - PROVIDE EXTRA BLOCKING

ALL EXTERIOR MATERIALS ARE TO MATCH EXISTING MATERIALS. ANY DEVIATIONS ARE TO BE APPROVED BY THE ARCHITECT.

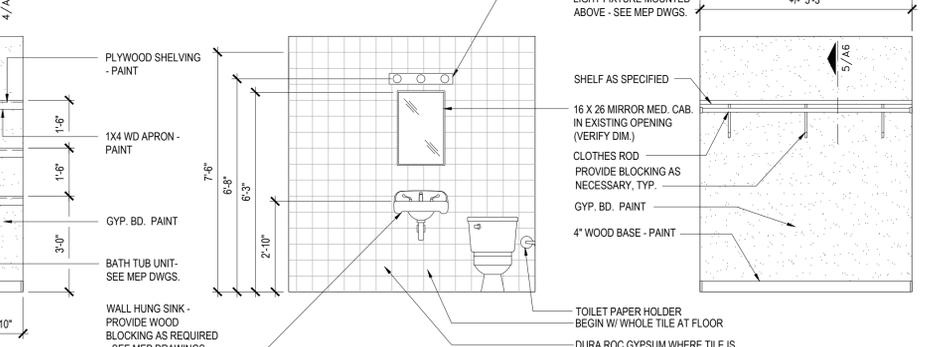

7 BATHROOM ELEV - UNIT 942
3/8" = 1'-0"

ALL EXTERIOR MATERIALS ARE TO MATCH EXISTING MATERIALS. ANY DEVIATIONS ARE TO BE APPROVED BY THE ARCHITECT.

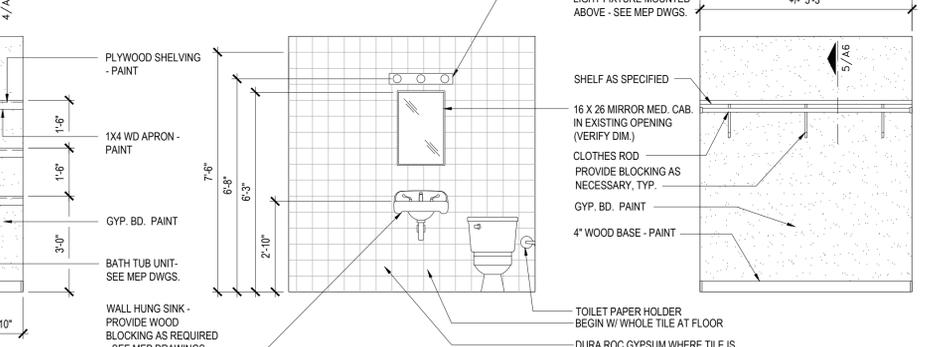

8 BATHROOM ELEV - UNIT 942
3/8" = 1'-0"

ALL UNITS WILL HAVE NEW SMOKE AND CARBON MONOXIDE DETECTORS IN ALL BEDROOMS AND LIVING ROOMS

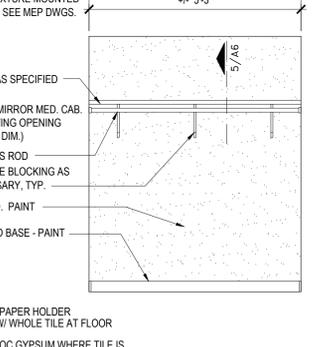

9 TYP. CLOSET SHELF ELEVATION
3/8" = 1'-0"

GENERAL NOTES
GENERAL CONTRACTOR SHALL VERIFY EXISTING STUD WIDTH PRIOR TO ORDERING DOOR & FRAMES.

DOOR SCHEDULE - UNIT 2404 & UNIT 103												
#	DOOR			EXISTING STUD WIDTH +/-	FRAME			DETAILS			HWDR. SET	HARDWARE
	TYPE	WIDTH	HEIGHT		MAT'L	FINISH	HEAD	JAMB	THRESHOLD	WALL		
01A	C	3'-0"	6'-8"	MTL	3 1/2"	PTD	-	-	-	1,3,6	PRIVACY LOCKSET / KEYPAD DEADBOLT	
01B	A	3'-0"	6'-8"	SC	3 1/2"	WD	PTD	2/A7	8/A7	13/A7	1,2,3,6	PRIVACY / KEYPAD DEAD / SING. SID. DEAD.
02A	C	3'-0"	6'-8"	SC	3 1/2"	WD	PTD	-	-	-	1,3,6	PRIVACY LOCKSET / KEYPAD DEADBOLT
02B	A	3'-0"	6'-8"	SC	3 1/2"	WD	PTD	2/A7	8/A7	16/A7	1,2,3,5	PRIVACY / KEYPAD DEAD / SING. SID. DEAD.
03	B	2'-8"	6'-8"	HC	3 1/2"	WD	PTD	3/A7	9/A7	-	4	PASSAGE
04	B	2'-8"	6'-8"	HC	3 1/2"	WD	PTD	3/A7	9/A7	-	4,5	PASSAGE
05	B	2'-8"	6'-8"	HC	3 1/2"	WD	PTD	3/A7	9/A7	-	4,5	PASSAGE
06	B	2'-8"	6'-8"	HC	3 1/2"	WD	PTD	3/A7	9/A7	-	1,5	PRIVACY
07	B	2'-8"	6'-8"	HC	3 1/2"	WD	PTD	3/A7	9/A7	-	4,5	PASSAGE
08	W	2'-2"	6'-8"	HC	3 1/2"	WD	PTD	3/A7	9/A7	-	4	PASSAGE

DOOR SCHEDULE - UNIT 1523 & UNIT 3023												
#	DOOR			EXISTING STUD WIDTH +/-	FRAME			DETAILS			HWDR. SET	HARDWARE
	TYPE	WIDTH	HEIGHT		MAT'L	FINISH	HEAD	JAMB	THRESHOLD	WALL		
01A	C	3'-0"	6'-8"	MTL	3 1/2"	MTL	PTD	-	-	-	1,3,6	PRIVACY LOCKSET / KEYPAD DEADBOLT
01B	A	3'-0"	6'-8"	SC	3 1/2"	WD	PTD	4/A7	10/A7	10/A7	1,2,3,5	PRIVACY / KEYPAD DEAD / SING. SID. DEAD.
02A	C	3'-0"	6'-8"	SC	3 1/2"	WD	PTD	-	-	-	1,3,6	PRIVACY LOCKSET / KEYPAD DEADBOLT
02B	A	3'-0"	6'-8"	SC	3 1/2"	WD	PTD	4/A7	10/A7	10/A7	1,2,3,5	PRIVACY / KEYPAD DEAD / SING. SID. DEAD.
04	B	2'-8"	6'-8"	HC	3 1/2"	WD	PTD	3/A7	9/A7	-	4,5	PASSAGE
05	B	2'-8"	6'-8"	HC	3 1/2"	WD	PTD	3/A7	9/A7	-	4,5	PASSAGE
06	B	2'-8"	6'-8"	HC	3 1/2"	WD	PTD	3/A7	9/A7	-	4,5	PASSAGE
07	B	2'-8"	6'-8"	HC	3 1/2"	WD	PTD	3/A7	9/A7	-	1,5	PRIVACY
08	W	2'-4"	6'-8"	HC	3 1/2"	WD	PTD	3/A7	9/A7	-	4,5	PASSAGE
09	B	2'-8"	6'-8"	HC	3 1/2"	WD	PTD	3/A7	9/A7	-	4,5	PASSAGE

DOOR SCHEDULE - UNIT 1501												
#	DOOR			EXISTING STUD WIDTH +/-	FRAME			DETAILS			HWDR. SET	HARDWARE
	TYPE	WIDTH	HEIGHT		MAT'L	FINISH	HEAD	JAMB	THRESHOLD	WALL		
01A	C	3'-0"	6'-8"	MTL	3 1/2"	MTL	PTD	-	-	-	1,3,6	PRIVACY LOCKSET / KEYPAD DEADBOLT
01B	A	3'-0"	6'-8"	SC	3 1/2"	WD	PTD	4/A7	10/A7	13/A7	1,2,3,5	PRIVACY / KEYPAD DEAD / SING. SID. DEAD.
02A	C	3'-0"	6'-8"	SC	3 1/2"	WD	PTD	-	-	-	1,3,5	PRIVACY LOCKSET / KEYPAD DEADBOLT
02B	A	3'-0"	6'-8"	SC	3 1/2"	WD	PTD	4/A7	10/A7	16/A7	1,2,3,6	PRIVACY / KEYPAD DEAD / SING. SID. DEAD.
03	B	2'-8"	6'-8"	HC	3 1/2"	WD	PTD	3/A7	9/A7	-	4	PASSAGE
04	B	2'-8"	6'-8"	HC	3 1/2"	WD	PTD	3/A7	9/A7	-	4,5	PASSAGE
06	B	2'-8"	6'-8"	HC	3 1/2"	WD	PTD	3/A7	9/A7	-	1,5	PRIVACY
07	B	2'-8"	6'-8"	HC	3 1/2"	WD	PTD	3/A7	9/A7	-	4,5	PASSAGE
08	B	2'-8"	6'-8"	HC	3 1/2"	WD	PTD	3/A7	9/A7	-	4	PASSAGE
09	B	2'-8"	6'-8"	HC	3 1/2"	WD	PTD	3/A7	9/A7	-	4,5	PASSAGE
10	B	2'-8"	6'-8"	HC	3 1/2"	WD	PTD	3/A7	9/A7	-	4,5	PASSAGE
11	W	2'-6"	6'-8"	HC	3 1/2"	WD	PTD	3/A7	9/A7	-	4	PASSAGE

DOOR SCHEDULE - UNIT 942												
#	DOOR			EXISTING STUD WIDTH +/-	FRAME			DETAILS			HWDR. SET	HARDWARE
	TYPE	WIDTH	HEIGHT		MAT'L	FINISH	HEAD	JAMB	THRESHOLD	WALL		
01A	C	3'-0"	6'-8"	MTL	3 1/2"	MTL	PTD	-	-	-	1,3,6	PRIVACY LOCKSET / KEYPAD DEADBOLT
01B	A	3'-0"	6'-8"	SC	3 1/2"	WD	PTD	4/A7	10/A7	13/A7	1,2,3,5	PRIVACY / KEYPAD DEAD / SING. SID. DEAD.
02	B	2'-8"	6'-8"	HC	3 1/2"	WD	PTD	3/A7	9/A7	-	4,5	PASSAGE
03A	C	3'-0"	6'-8"	MTL	3 1/2"	MTL	PTD	-	-	-	1,3,6	PRIVACY LOCKSET / KEYPAD DEADBOLT
03B	A	3'-0"	6'-8"	SC	3 1/2"	WD	PTD	4/A7	10/A7	13/A7	1,2,3,5	PRIVACY / KEYPAD DEAD / SING. SID. DEAD.
04	B	2'-8"	6'-8"	HC	3 1/2"	WD	PTD	3/A7	9/A7	-	4	PASSAGE
05	B	2'-8"	6'-8"	HC	3 1/2"	WD	PTD	3/A7	9/A7	-	1,5	PRIVACY
06	B	2'-8"	6'-8"	HC	3 1/2"	WD	PTD	3/A7	9/A7	-	4,5	PASSAGE
07	B	2'-8"	6'-8"	HC	3 1/2"	WD	PTD	3/A7	9/A7	-	4,5	PASSAGE
08	B	2'-8"	6'-8"	HC	3 1/2"	WD	PTD	3/A7	9/A7	-	4,5	PASSAGE

DOOR SCHEDULE - UNIT 1818												
#	DOOR			EXISTING STUD WIDTH +/-	FRAME			DETAILS			HWDR. SET	HARDWARE
	TYPE	WIDTH	HEIGHT		MAT'L	FINISH	HEAD	JAMB	THRESHOLD	WALL		
01A	C	3'-0"	6'-8"	MTL	3 1/2"	MTL	PTD	-	-	-	1,3,6	PASSAGE LOCKSET / DEADBOLT
01B	A	3'-0"	6'-8"	SC	3 1/2"	WD	PTD	4/A7	10/A7	13/A7	1,2,3	PASSAGE / PRIVACY LOCKSET & DEADBOLT
02	B	2'-8"	6'-8"	HC	3 1/2"	WD	PTD	3/A7	9/A7	-	4,5	PASSAGE
03	B	2'-8"	6'-8"	HC	3 1/2"	WD	PTD	3/A7	9/A7	-	4,5	PASSAGE
04	B	2'-8"	6'-8"	HC	3 1/2"	WD	PTD	3/A7	9/A7	-	1,5	PRIVACY
05A	A	3'-0"	6'-8"	SC	3 1/2"	WD	PTD	4/A7	10/A7	-	1,2,3	PASSAGE / PRIVACY LOCKSET & DEADBOLT
05B	C	3'-0"	6'-8"	MTL	3 1/2"	MTL	PTD	-	-	13/A7	1,3,6	PASSAGE LOCKSET / DEADBOLT
07	E	2'-8"	6'-8"	HC	3 1/2"	WD	PTD	3/A7	9/A7	-	4,5	PASSAGE LOCKSET / DEADBOLT
08	B	2'-8"	6'-8"	HC	3 1/2"	WD	PTD	3/A7	9/A7	-	4	PASSAGE
09	B	2'-8"	6'-8"	HC	3 1/2"	WD	PTD	3/A7	9/A7	-	4,5	PASSAGE
10	B	2'-8"	6'-8"	HC	3 1/2"	WD	PTD	3/A7	9/A7	-	4,5	PASSAGE
11	B	2'-8"	6'-8"	HC	3 1/2"	WD	PTD	3/A7	9/A7	-	4,5	PASSAGE
12	B	2'-8"	6'-8"	HC	3 1/2"	WD	PTD	3/A7	9/A7	-	1,5	PRIVACY

ALL UNITS WILL HAVE NEW WOOD DOOR FRAMES ON FIRST AND SECOND FLOOR.												
HARDWARE SET												
1. SHIELD SECURITY - PRIVACY LOCKSET / GRADE 3 - 2 WAY LATCH / TULIP KNOB STYLE / SATIN CHROME FINISH												
2. KWIKSET - SINGLE SIDED DEADBOLT WITH BACK PLATE / GRADE 3 NON-COMMERCIAL MFG #667 / SATIN CHROME												
3. KWIKSET - SINGLE CYLINDER DEADBOLT - INDIVIDUALLY KEYPAD - NON-MASTERED KEYPAD MFG #GDC9471 / SATIN CHROME												
4. SHIELD SECURITY - PASSAGE / GRADE 3 - 2 WAY LATCH / TULIP KNOB STYLE / SATIN CHROME FINISH												
5. DOOR STOP - BOTTOM DOOR STOP / SATIN CHROME FINISH												
6. DOOR STOP - HANDLE DOOR STOP / SATIN CHROME FINISH												
7. EYE VIEWER - AS SPECIFIED												

NOTE: CONTRACTOR TO SUBMIT FINISH SPECIFICATIONS AND SAMPLES PRIOR TO ORDERING FOR OWNER AND ARCHITECT FINAL APPROVAL.

ROOM FINISH SCHEDULE - UNITS 2404 & UNITS 103										
RM #	ROOM NAME	FLOOR	BASE	WALLS				CEILING	CEILING HEIGHT	
				NORTH	SOUTH	WEST	EAST			
101	LIVING ROOM	F1	B1	W1	W1	W1	W1	C1	+/- 8'-0"	
102	DINING ROOM	F1	B1	W1	W1	W1	W1	C1	+/- 8'-0"	
103	KITCHEN	F1	B1	W1	W1	W1	W1	C1	+/- 8'-0"	
104	HALL	F1	B1	W1	W1	W1	W1	C1	+/- 8'-0"	
105	BEDROOM #01	F1	B1	W1	W1	W1	W1	C1	+/- 8'-0"	
106	BEDROOM #02	F1	B1	W1	W1	W1	W1	C1	+/- 8'-0"	
107	BATH	F2	B2	W1/W2	W1/W2	W1/W2	W1/W2	C1	+/- 8'-0"	

ROOM FINISH SCHEDULE - UNIT 1523 & UNIT 3023										
RM #	ROOM NAME	FLOOR	BASE	WALLS				CEILING	CEILING HEIGHT	
				NORTH	SOUTH	WEST	EAST			
101	LIVING ROOM	F1	B1	W1	W1	W1	W1	C1	+/- 8'-0"	
102	KITCHEN / DINING ROOM	F1	B1	W1	W1	W1	W1	C1	+/- 8'-0"	
103	STORAGE	F1	B1	W1	W1	W1	W1	C1	+/- 8'-0"	
104	HALL	F1	B1	W1	W1	W1	W1	C1	+/- 8'-0"	
105	BATH	F2	B2	W1/W2	W1/W2	W1/W2	W1/W2	C1	+/- 8'-0"	
106	BEDROOM #01	F1	B1	W1	W1	W1	W1	C1	+/- 8'-0"	
107	BEDROOM #02	F1	B1	W1	W1	W1	W1	C1	+/- 8'-0"	
108	BEDROOM #03	F1	B1	W1	W1	W1	W1	C1	+/- 8'-0"	

ROOM FINISH SCHEDULE - UNIT 1501										
RM #	ROOM NAME	FLOOR	BASE	WALLS				CEILING	CEILING HEIGHT	
				NORTH	SOUTH	WEST	EAST			
101	LIVING ROOM	F1	B1	W1	W1	W1	W1	C1	+/- 8'-0"	
102	KITCHEN / DINING ROOM	F1	B1	W1	W1	W1	W1	C1	+/- 8'-0"	
103	BEDROOM #01	F1	B1	W1	W1	W1	W1	C1	+/- 8'-0"	
104	STORAGE	F1	B1	W1	W1	W1	W1	C1	+/- 8'-0"	
105	HALL	F1	B1	W1	W1	W1	W1	C1	+/- 8'-0"	
106	BATH	F2	B2	W1/W2	W1/W2	W1/W2	W1/W2	C1	+/- 8'-0"	
107	BEDROOM #02	F1	B1	W1	W1	W1	W1	C1	+/- 8'-0"	
108	BEDROOM #03	F1	B1	W1	W1	W1	W1	C1	+/- 8'-0"	
109	BEDROOM #04	F1	B1	W1	W1	W1	W1	C1	+/- 8'-0"	
110	BEDROOM #05	F1	B1	W1	W1	W1	W1	C1	+/- 8'-0"	

ROOM FINISH SCHEDULE - UNIT 942										
RM #	ROOM NAME	FLOOR	BASE	WALLS				CEILING	CEILING HEIGHT	
				NORTH	SOUTH	WEST	EAST			
101	LIVING ROOM	F1	B1	W1	W1	W1	W1	C1	+/- 8'-0"	
102	DINING ROOM	F1	B1	W1	W1	W1	W1	C1	+/- 8'-0"	
103	KITCHEN	F1	B1	W1	W1	W1	W1	C1	+/- 8'-0"	
104	HALL	F1	B1	W1	W1	W1	W1	C1	+/- 7'-1"	
105	STORAGE	F1	B1	W1	W1	W1	W1	C1	+/- 7'-1"	
106	BATH	F2	B2	W1/W2	W1/W2	W1/W2	W1/W2	C1	+/- 7'-1"	
107	HEATER ROOM	CONC	W1	W1	W1	W1	W1	C1	+/- 8'-0"	
108	BEDROOM #01	F1	B1	W1	W1	W1	W1	C1	+/- 8'-0"	
109	BEDROOM #02	F1	B1	W1	W1	W1	W1	C1	+/- 8'-0"	
110	BEDROOM #03	F1	B1	W1	W1	W1	W1	C1	+/- 8'-0"	

ROOM FINISH SCHEDULE - UNIT 1818										
RM #	ROOM NAME	FLOOR								

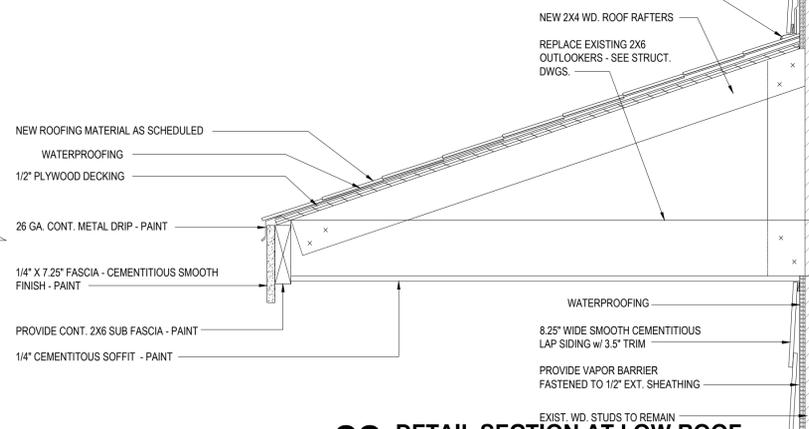
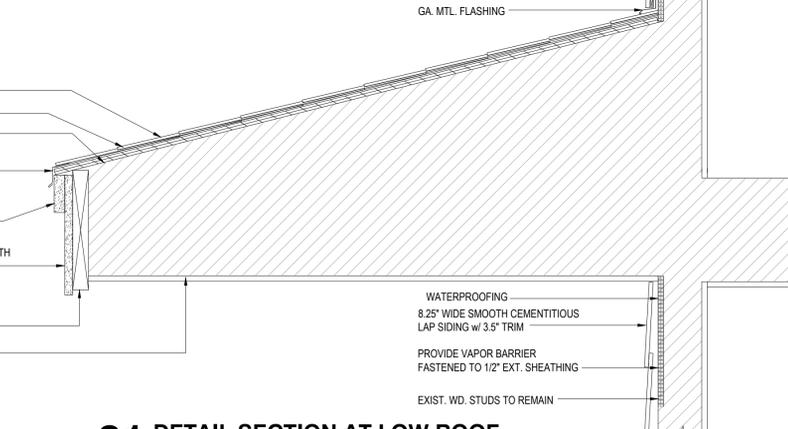
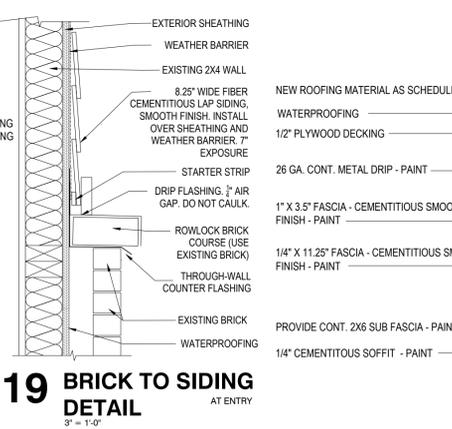
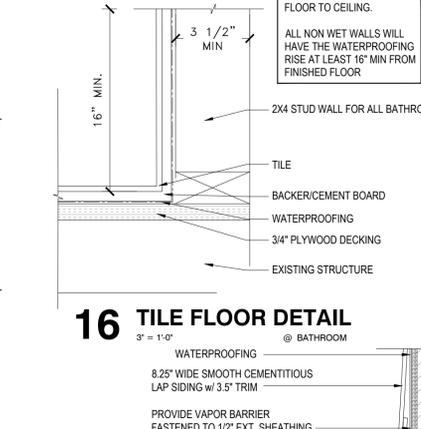
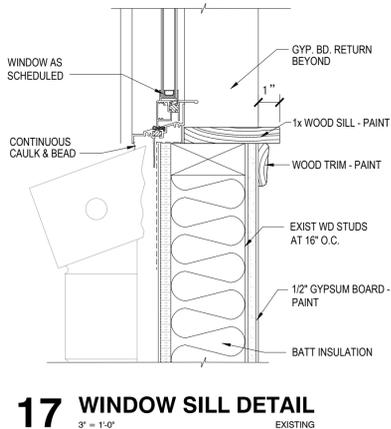
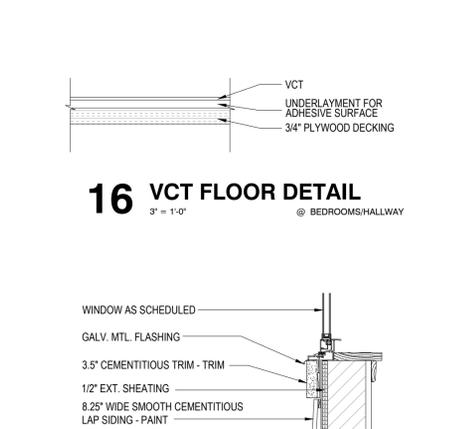
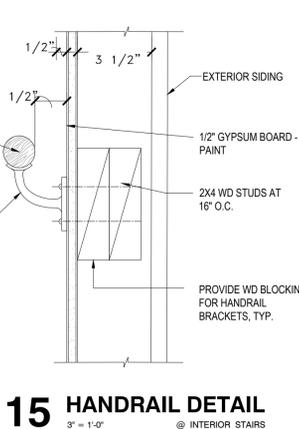
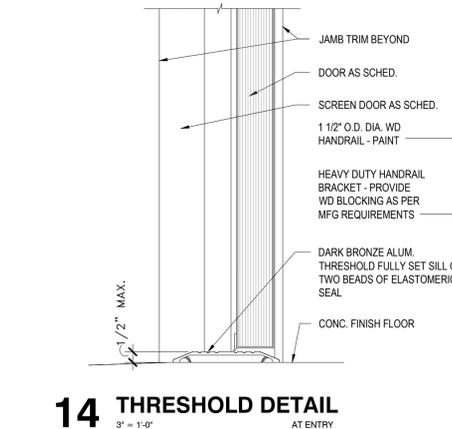
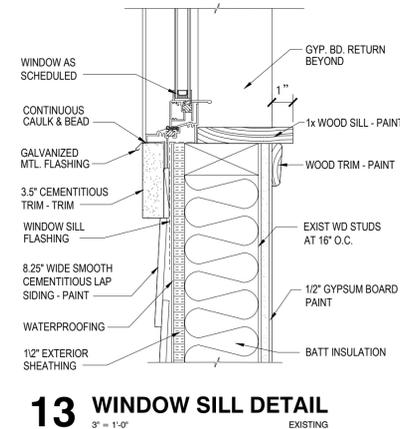
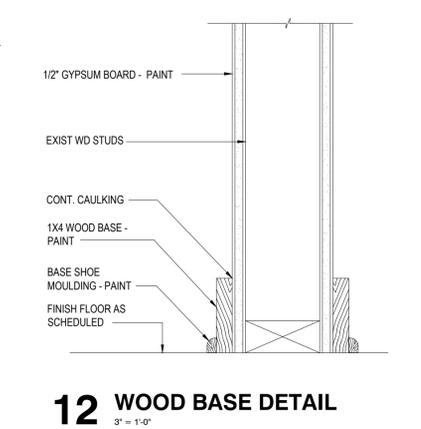
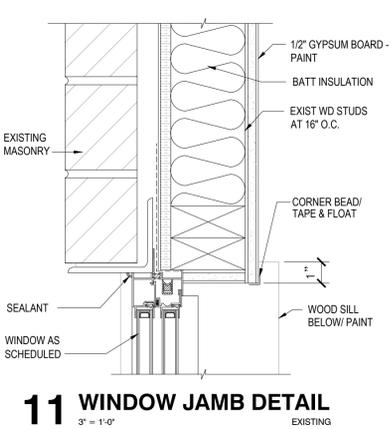
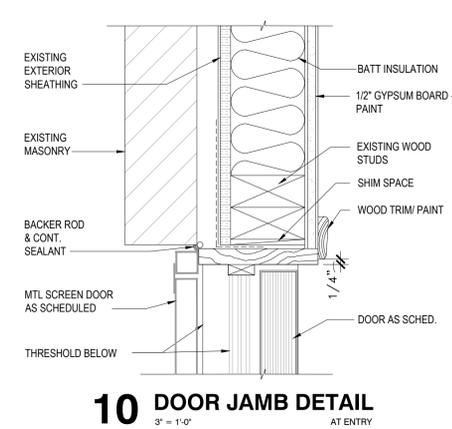
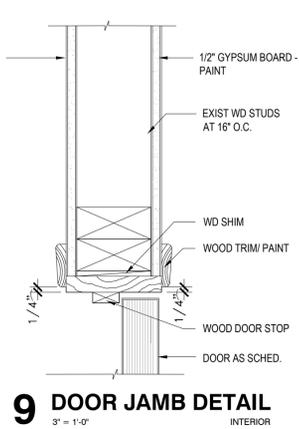
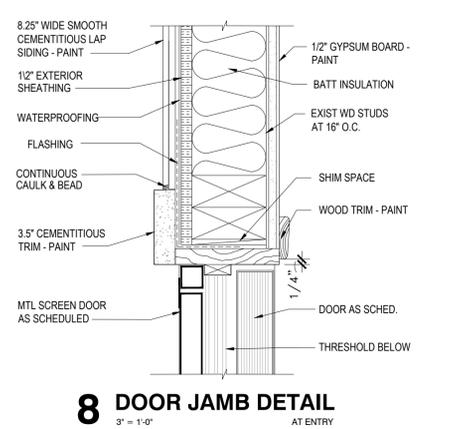
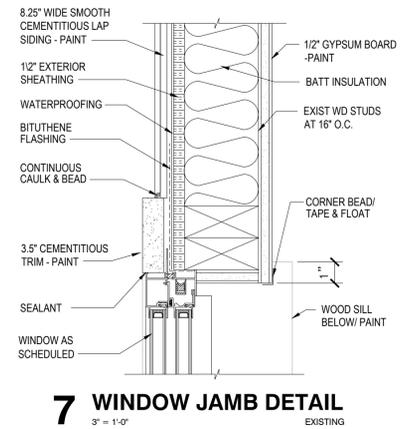
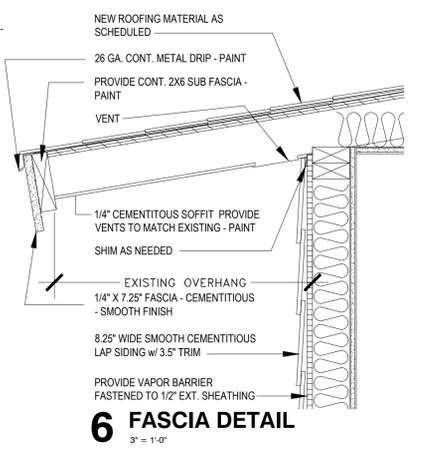
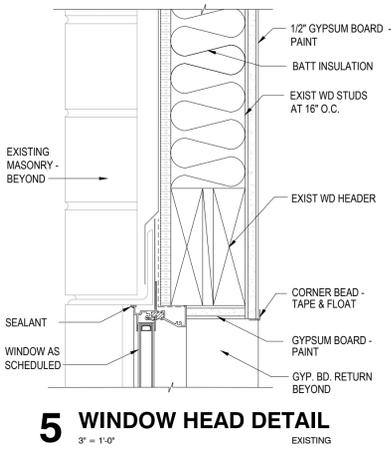
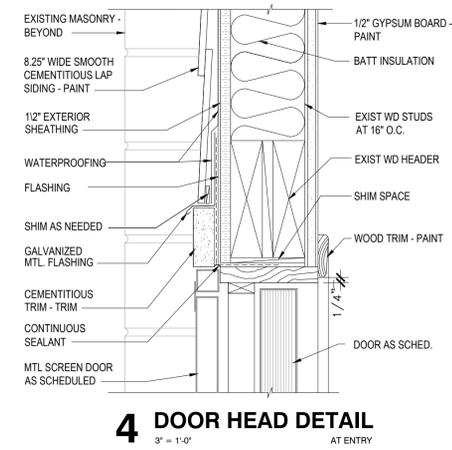
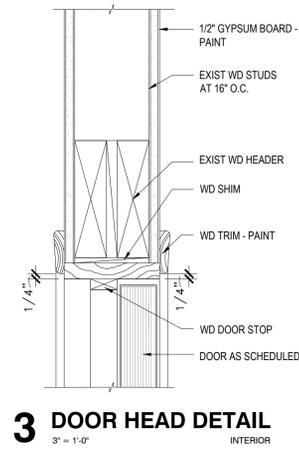
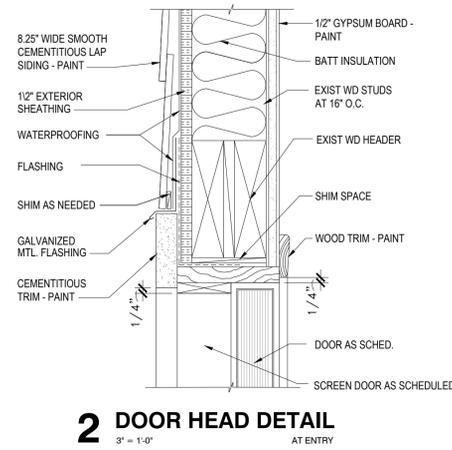
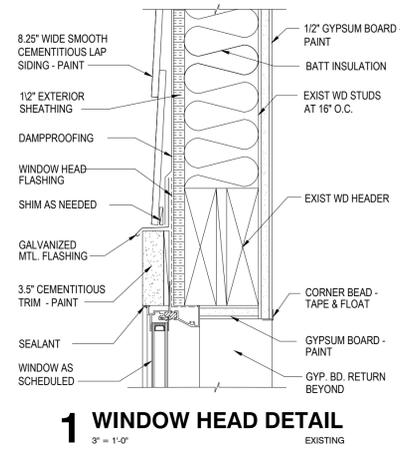

ALL WET WALLS WILL HAVE THE WATERPROOFING FROM FLOOR TO CEILING.
ALL NON WET WALLS WILL HAVE THE WATERPROOFING RISE AT LEAST 16\"/>

KEY NOTES

- ① REPLACE EXISTING BURNED 2x3 WALL STUDS WITH NEW 2x3 WALL STUDS AT 16" O.C.
- ② REPLACE EXISTING BURNED 2-2x4 WOOD HEADER WITH NEW 2-2x6 HEADER
- ③ REPLACE EXISTING BURNED WOOD SOFFIT WITH NEW SOFFIT. SEE ARCH. DWGS.
- ④ REPLACE EXISTING BURNED WOOD SIDING. SEE ARCHITECTURAL DRAWINGS FOR HARDIPLANK TYPE AND COLOR.
- ⑤ REPLACE EXISTING BURNED FLOOR DECK WITH 3/4" PLYWOOD FLOOR DECKING.
- ⑥ REPLACE EXISTING BURNED ROOF DECK WITH 1/2" PLYWOOD ROOF DECKING.
- ⑦ REPLACE MISSING 2x3 SOLE PLATE WITH NEW 2x3 SOLE PLATE.
- ⑧ REPLACE EXISTING WATER DAMAGED WINDOW SILL PLATE.
- ⑨ REPLACE EXISTING WATER DAMAGED FLOOR DECK WITH 3/4" PLYWOOD FLOOR DECKING.
- ⑩ REPLACE MISSING 2x3 WALL STUDS AT 16" O.C. WITH NEW 2x3 WALL STUDS.
- ⑪ REPLACE MISSING 2x4 WALL STUDS AT 16" O.C. WITH NEW 2x4 WALL STUDS.
- ⑫ REPLACE 2-2x6 HEADER
- ⑬ EXISTING COLUMNS TO BE REMOVED. EXISTING WOOD BEAM ABOVE TO REMAIN.
- ⑭ REPLACE CRIPPLE STUD WITH NEW 2x3 CRIPPLE STUD.
- ⑮ REPLACE DAMAGED FLOOR DECK WITH 3/4" PLYWOOD FLOOR DECKING.
- ⑯ REPLACE EXISTING WATER DAMAGED SHEATHING WITH 1/2" PLYWOOD WHERE EXISTING MASONRY VENEER OCCURS MASONRY WALL HAVE TO BE REMOVED AND REPLACED.
- ⑰ REPLACE EXISTING WATER DAMAGED 2x4 SOLE PLATE.
- ⑱ REPLACE 2-2x8 HEADER WITH NEW 2-2x8 HEADER
- ⑲ REPLACE EXISTING RAFTER TAILS WITH NEW 2x4 RAFTER TAILS AT ROOF LEVEL.
- ⑳ REPLACE EXISTING BURNED 2x10 AT 16" O.C. FRAMING WITH NEW 2x10 JOISTS AT 16" O.C. (U.N.O.)
- ㉑ REPLACE EXISTING 2x6 OUTLOOKERS WITH NEW 2x6 OUTLOOKERS AT SECOND FLOOR LEVEL.
- ㉒ REPLACE EXISTING BURNED 2x4 WALL STUDS AT 16" O.C., 2x4 SOLE PLATE AND 2-2x4 TOP PLATE WITH NEW MEMBERS OF SAME SIZE AND SPACING.
- ㉓ REPLACE WATER DAMAGED 2x4 WALL STUDS WITH NEW 2x4 WALL STUDS @ 16" O.C.

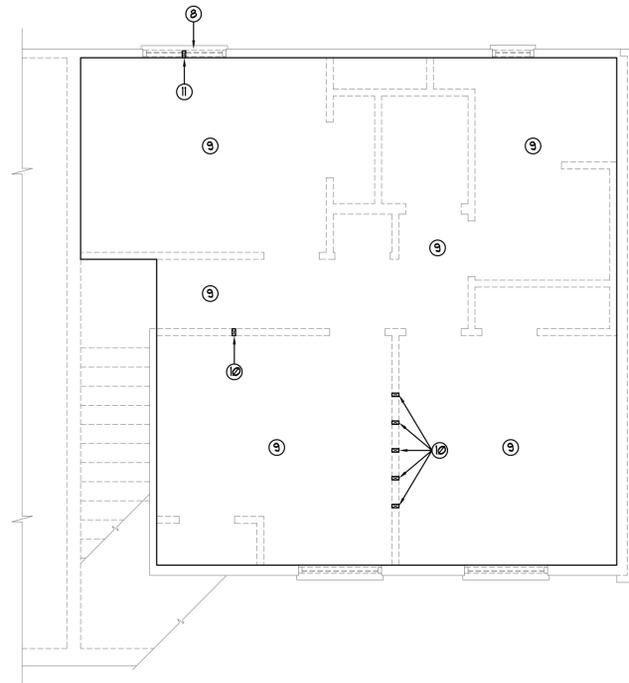

UNIT A2 - SECOND FLOOR PLAN - UNIT 1818 KROCKER
SCALE : 1/4" = 1'-0" A2-181-2ND

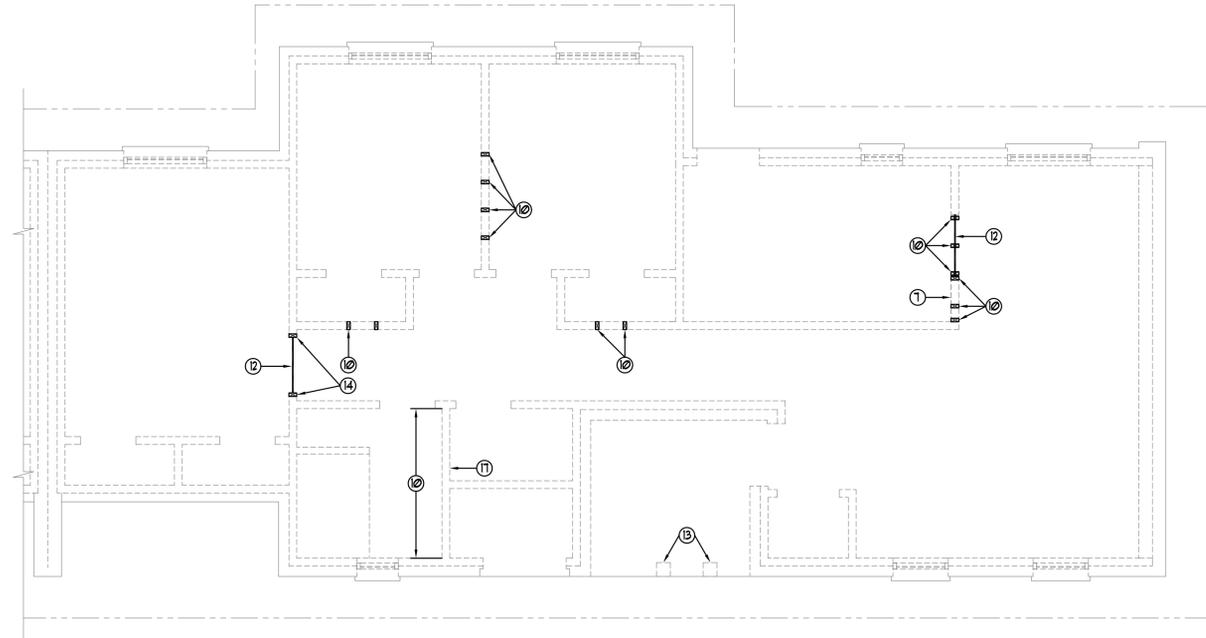

UNIT A1 - FIRST FLOOR PLAN - UNIT 942 MERIDA
SCALE : 1/4" = 1'-0" A1-181

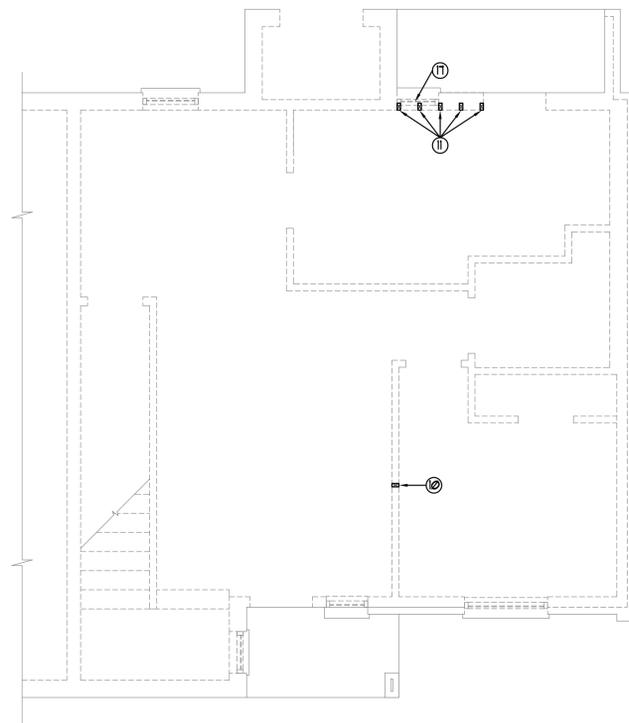

UNIT A2 - FIRST FLOOR PLAN - UNIT 1818 KROCKER
SCALE : 1/4" = 1'-0" A2-181-1ND

KEY NOTES

- 1 REPLACE EXISTING BURNED 2x3 WALL STUDS WITH NEW 2x3 WALL STUDS AT 16" O.C.
- 2 REPLACE EXISTING BURNED 2-2x4 WOOD HEADER WITH NEW 2-2x6 HEADER.
- 3 REPLACE EXISTING BURNED WOOD SOFFIT WITH NEW SOFFIT. SEE ARCH. DWGS.
- 4 REPLACE EXISTING BURNED WOOD SIDING. SEE ARCHITECTURAL DRAWINGS FOR HARDPLANK TYPE AND COLOR.
- 5 REPLACE EXISTING BURNED FLOOR DECK WITH 3/4" PLYWOOD FLOOR DECKING.
- 6 REPLACE EXISTING BURNED ROOF DECK WITH 1/2" PLYWOOD ROOF DECKING.
- 7 REPLACE MISSING 2x3 SOLE PLATE WITH NEW 2x3 SOLE PLATE.
- 8 REPLACE EXISTING WATER DAMAGED WINDOW SILL PLATE.
- 9 REPLACE EXISTING WATER DAMAGED FLOOR DECK WITH 3/4" PLYWOOD FLOOR DECKING.
- 10 REPLACE MISSING 2x3 WALL STUDS AT 16" O.C. WITH NEW 2x3 WALL STUDS.
- 11 REPLACE MISSING 2x4 WALL STUDS AT 16" O.C. WITH NEW 2x4 WALL STUDS.
- 12 REPLACE 2-2x6 HEADER.
- 13 EXISTING COLUMNS TO BE REMOVED. EXISTING WOOD BEAM ABOVE TO REMAIN.
- 14 REPLACE CRIPPLE STUD WITH NEW 2x3 CRIPPLE STUD.
- 15 REPLACE DAMAGED FLOOR DECK WITH 3/4" PLYWOOD FLOOR DECKING.
- 16 REPLACE EXISTING WATER DAMAGED SHEATHING WITH 1/2" PLYWOOD, WHERE EXISTING MASONRY VENEER OCCURS MASONRY WALL HAVE TO BE REMOVED AND REPLACED.
- 17 REPLACE EXISTING WATER DAMAGED 2x4 SOLE PLATE.
- 18 REPLACE 2-2x8 HEADER WITH NEW 2-2x8 HEADER.
- 19 REPLACE EXISTING RAFTER TAILS WITH NEW 2x4 RAFTER TAILS AT ROOF LEVEL.
- 20 REPLACE EXISTING BURNED 2x10 AT 16" O.C. FRAMING WITH NEW 2x10 JOISTS AT 16" O.C. (U.N.O.)
- 21 REPLACE EXISTING 2x6 OUTLOOKERS WITH NEW 2x6 OUTLOOKERS AT SECOND FLOOR LEVEL.
- 22 REPLACE EXISTING BURNED 2x4 WALL STUDS AT 16" O.C., 2x4 SOLE PLATE AND 2-2x4 TOP PLATE WITH NEW MEMBERS OF SAME SIZE AND SPACING.
- 23 REPLACE WATER DAMAGED 2x4 WALL STUDS WITH NEW 2x4 WALL STUDS @ 16" O.C.

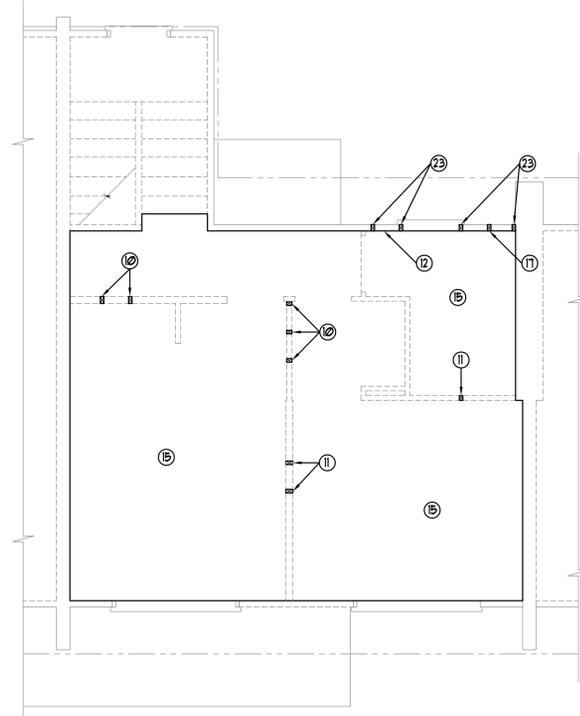

UNIT B - SECOND FLOOR PLAN - UNIT 103 SAN LINO
SCALE : 1/4" = 1'-0" UNIT B-187-2ND

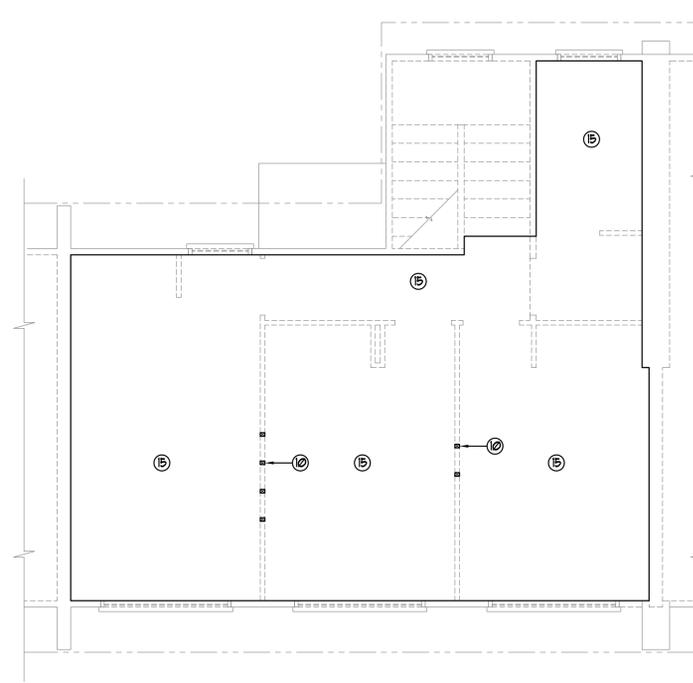

UNIT C - SECOND FLOOR PLAN - UNIT 1523 SAN CARLOS
SCALE : 1/4" = 1'-0" UNIT C-187-2ND

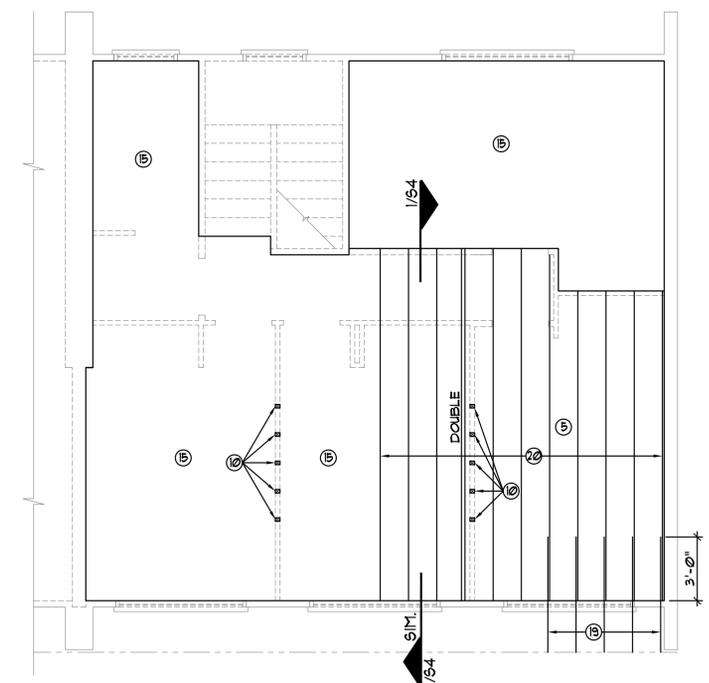

UNIT E - SECOND FLOOR PLAN - UNIT 1501 SAN CARLOS
SCALE : 1/4" = 1'-0" UNIT E-187-2ND

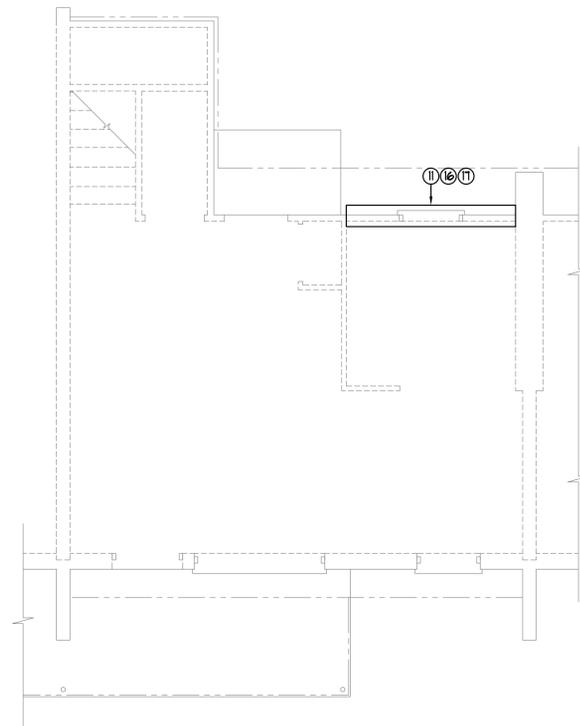

UNIT B - FIRST FLOOR PLAN UNIT 103 SAN LINO
SCALE : 1/4" = 1'-0" UNIT B-187-2ND

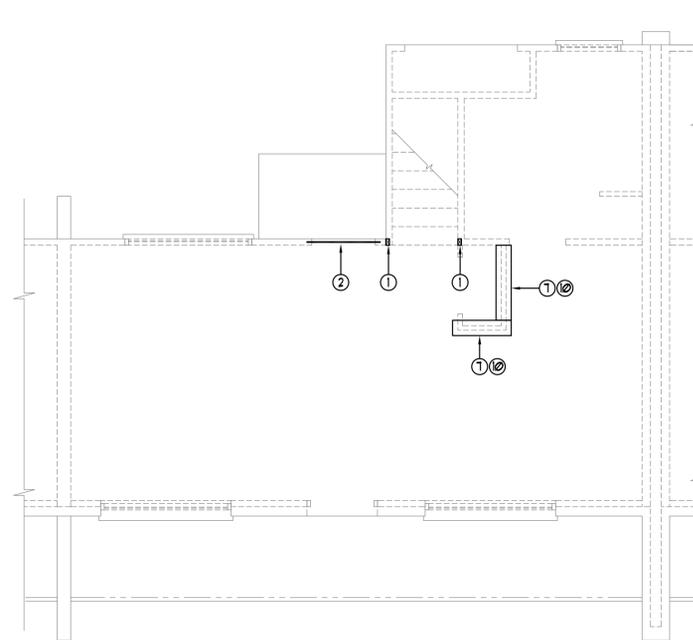

UNIT C - FIRST FLOOR PLAN UNIT 1523 SAN CARLOS
SCALE : 1/4" = 1'-0" UNIT C-187-2ND

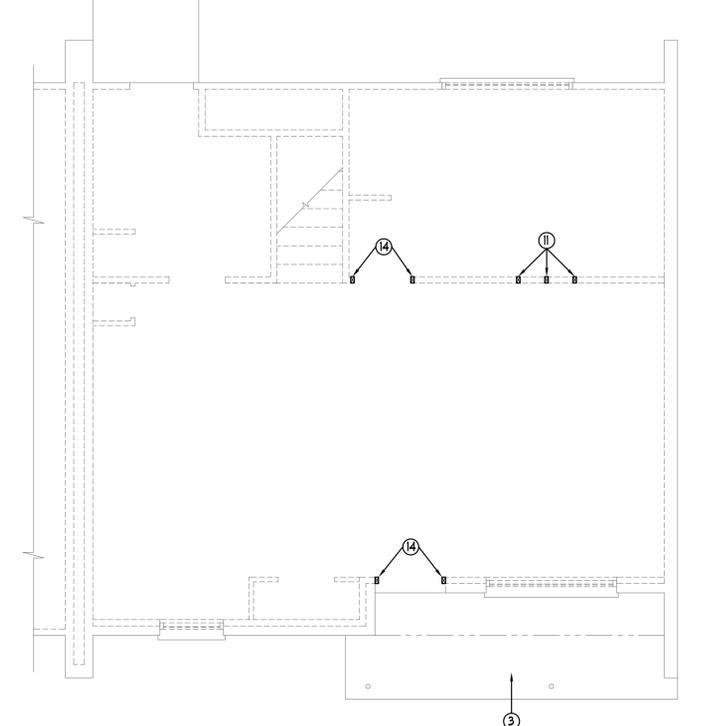

UNIT E - FIRST FLOOR PLAN UNIT 1501 SAN CARLOS
SCALE : 1/4" = 1'-0" UNIT E-187-2ND

KEY NOTES

- 1 REPLACE EXISTING BURNED 2x3 WALL STUDS WITH NEW 2x3 WALL STUDS AT 16" O.C.
- 2 REPLACE EXISTING BURNED 2-2x4 WOOD HEADER WITH NEW 2-2x6 HEADER.
- 3 REPLACE EXISTING BURNED WOOD SOFFIT WITH NEW SOFFIT. SEE ARCH. DWGS.
- 4 REPLACE EXISTING BURNED WOOD SIDING. SEE ARCHITECTURAL DRAWINGS FOR HARDIPLANK TYPE AND COLOR.
- 5 REPLACE EXISTING BURNED FLOOR DECK WITH 3/4" PLYWOOD FLOOR DECKING.
- 6 REPLACE EXISTING BURNED ROOF DECK WITH 1/2" PLYWOOD ROOF DECKING.
- 7 REPLACE MISSING 2x3 SOLE PLATE WITH NEW 2x3 SOLE PLATE.
- 8 REPLACE EXISTING WATER DAMAGED WINDOW SILL PLATE.
- 9 REPLACE EXISTING WATER DAMAGED FLOOR DECK WITH 3/4" PLYWOOD FLOOR DECKING.
- 10 REPLACE MISSING 2x3 WALL STUDS AT 16" O.C. WITH NEW 2x3 WALL STUDS.
- 11 REPLACE MISSING 2x4 WALL STUDS AT 16" O.C. WITH NEW 2x4 WALL STUDS.
- 12 REPLACE 2-2x6 HEADER.
- 13 EXISTING COLUMNS TO BE REMOVED. EXISTING WOOD BEAM ABOVE TO REMAIN.
- 14 REPLACE CRIPPLE STUD WITH NEW 2x3 CRIPPLE STUD.
- 15 REPLACE DAMAGED FLOOR DECK WITH 3/4" PLYWOOD FLOOR DECKING.
- 16 REPLACE EXISTING WATER DAMAGED SHEATHING WITH 1/2" PLYWOOD, WHERE EXISTING MASONRY VENEER OCCURS MASONRY WALL HAVE TO BE REMOVED AND REPLACED.
- 17 REPLACE EXISTING WATER DAMAGED 2x4 SOLE PLATE.
- 18 REPLACE 2-2x8 HEADER WITH NEW 2-2x8 HEADER.
- 19 REPLACE EXISTING RAFTER TAILS WITH NEW 2x4 RAFTER TAILS AT ROOF LEVEL.
- 20 REPLACE EXISTING BURNED 2x10 AT 16" O.C. FRAMING WITH NEW 2x10 JOISTS AT 16" O.C. (U.N.O.)
- 21 REPLACE EXISTING 2x6 OUTLOOKERS WITH NEW 2x6 OUTLOOKERS AT SECOND FLOOR LEVEL.
- 22 REPLACE EXISTING BURNED 2x4 WALL STUDS AT 16" O.C., 2x4 SOLE PLATE AND 2-2x4 TOP PLATE WITH NEW MEMBERS OF SAME SIZE AND SPACING.
- 23 REPLACE WATER DAMAGED 2x4 WALL STUDS WITH NEW 2x4 WALL STUDS @ 16" O.C.

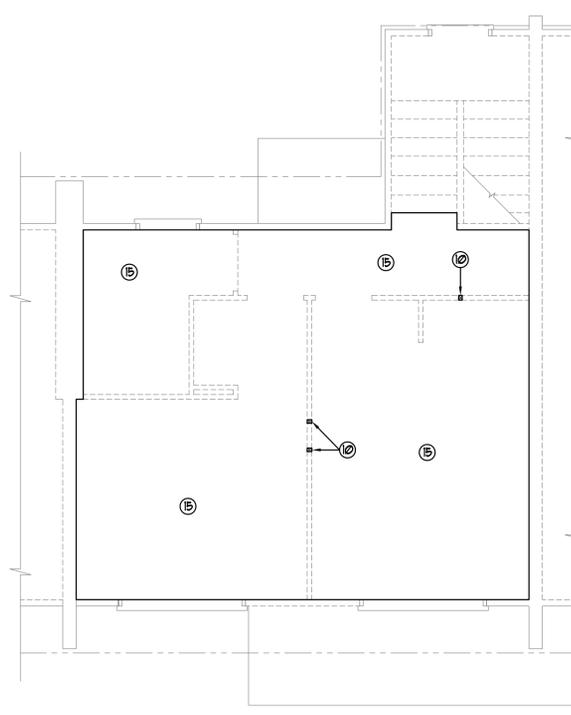

UNIT B - SECOND FLOOR PLAN - UNIT 2404 TAMPICO
SCALE: 1/4" = 1'-0" UNIT 2404

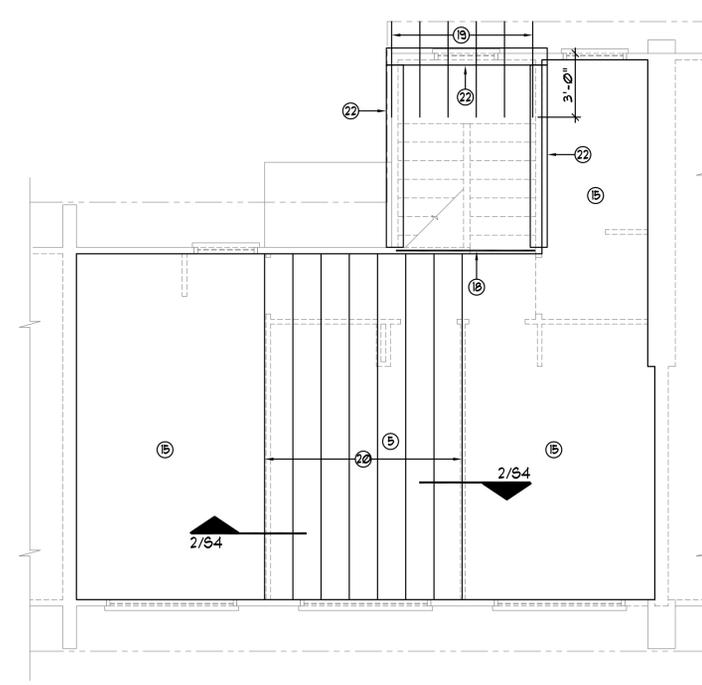

UNIT C - SECOND FLOOR PLAN - UNIT 3023 S LAREDO
SCALE: 1/4" = 1'-0" UNIT 3023

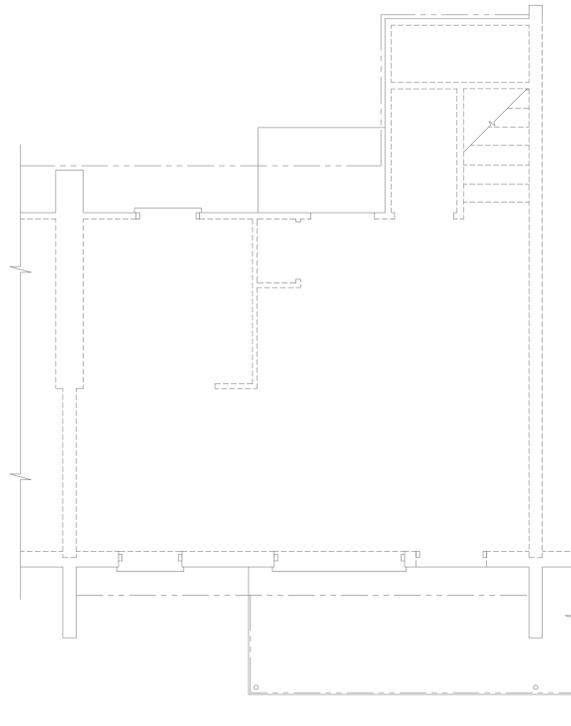

UNIT B - FIRST FLOOR PLAN - UNIT 2404 TAMPICO
SCALE: 1/4" = 1'-0" UNIT 2404

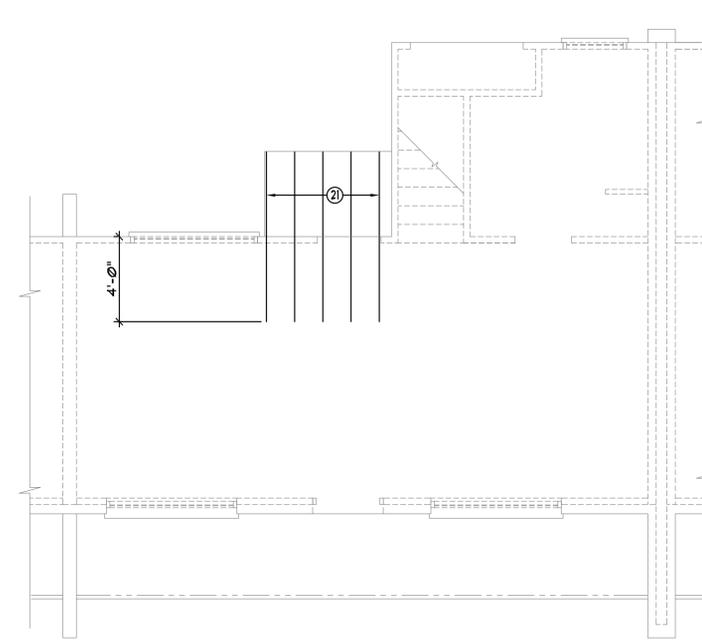

UNIT C - FIRST FLOOR PLAN - UNIT 3023 S LAREDO
SCALE: 1/4" = 1'-0" UNIT 3023

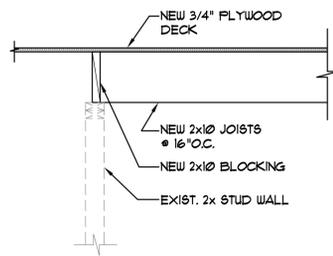

1 SECTION
SCALE: 3/4" = 1'-0"
SECT01

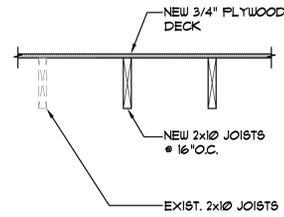

2 SECTION
SCALE: 3/4" = 1'-0"
SECT02

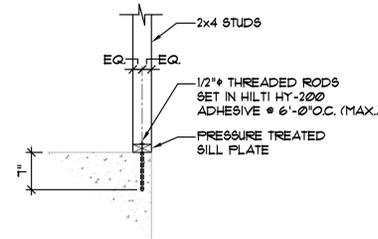

3 TYPICAL EXTERIOR SILL PLATE
SCALE: 3/4" = 1'-0"
SECT03

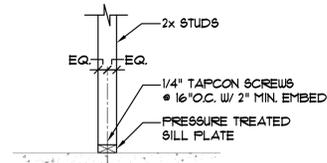

4 TYPICAL INTERIOR SILL PLATE
SCALE: 3/4" = 1'-0"
SECT04

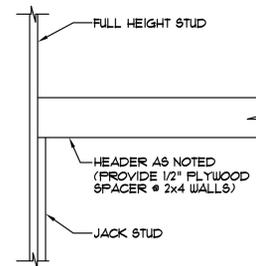

5 TYPICAL HEADER DETAIL
SCALE: 3/4" = 1'-0"
SECT05

GENERAL NOTES:

- THESE STRUCTURAL REPAIRS WERE DESIGNED IN ACCORDANCE WITH THE 2015 INTERNATIONAL RESIDENTIAL CODE AS ADOPTED AND AMENDED BY THE CITY OF SAN ANTONIO, AND THE INTERNATIONAL EXISTING BUILDING CODE.
- GRAVITY DESIGN LIVE LOADS USED ARE AS FOLLOWS:
 - A. FLOOR LIVE LOAD: 40 PSF
 - B. ROOF LIVE LOAD: 20 PSF
 - C. GROUND SNOW LOAD: 5 PSF
 - D. WIND LOAD CRITERIA: ULTIMATE WIND SPEED (3-SECOND GUST): 115 MPH
RISK CATEGORY II
EXPOSURE: B
MAXIMUM CONSIDERED EARTHQUAKE GROUND MOTION: 0.10g
 - E. SEISMIC LOAD CRITERIA: D
 - F. SITE CLASS: D
- PRIOR TO BUILDING, CONTRACTOR SHALL VISIT THE APARTMENTS INCLUDED IN THIS PROJECT. CONTRACTOR'S BID SHALL INCLUDE ALL SHORING, AUXILIARY FRAMING, FASTENERS REQUIRED TO COMPLETE THE REPAIRS INDICATED IN THESE RESTORATION DOCUMENTS.
- THE USE OF REPRODUCTIONS OF THESE CONTRACT DRAWINGS BY ANY CONTRACTOR, SUBCONTRACTOR, ERECTOR, FABRICATOR, OR MATERIAL SUPPLIER IN LIEU OF PREPARATION OF SHOP DRAWINGS SIGNIFIES HIS ACCEPTANCE OF ALL INFORMATION SHOWN HEREIN AS CORRECT, AND OBLIGATES HIMSELF TO ANY AND ALL EXPENSES, REAL OR IMPLIED ARISING FROM SUCH ACCEPTANCE. THE CONTRACTOR SHALL MAINTAIN THESE DRAWINGS AT A CURRENT STATUS, INCLUDING ALL ADDENDA AND REVISIONS.

DEMOLITION NOTES:

- THE CONTRACTOR MUST REVIEW ALL WORK TO ASCERTAIN THAT ACTUAL STRUCTURAL CONDITIONS ENCOUNTERED REFLECT THOSE SHOWN ON THE STRUCTURAL DRAWINGS AND REPORT ANY DISCREPANCIES TO THE ENGINEER.
- DURING DEMOLITION CONTRACTOR SHALL IDENTIFY STRUCTURAL FRAMING AND LOAD PATHS IN AREA OF DEMOLITION TO PREVENT ACCIDENTAL COLLAPSE.
- CONTRACTOR SHALL BE RESPONSIBLE FOR PROVIDING ALL BRACING AND SHORING REQUIRED TO INSURE THE SAFETY AND STRUCTURAL INTEGRITY OF THE PROJECT DURING DEMOLITION OPERATIONS.
- CONTRACTOR SHALL INSPECT EXISTING STRUCTURAL ELEMENTS AND REPAIR OR REPLACE THOSE FOUND TO BE STRUCTURALLY UNSOUND AS DIRECTED BY STRUCTURAL ENGINEER.

WOOD NOTES:

- ALL NEW STRUCTURAL FRAMING LUMBER SHALL BE KILN DRIED SOUTHERN YELLOW PINE, UNLESS NOTED OTHERWISE, OR APPROVED EQUAL AND SHALL CONFORM TO THE FOLLOWING MINIMUM GRADES:
 - A. JOISTS, HEADERS, COLUMNS--NO2 (FB=1,100 F&I MINIMUM)
 - B. PLATES, CAPS--UTILITY
 - C. STUDS--STUD GRADE
- ALL LUMBER SHALL BE GRADE STAMPED.
- PLYWOOD FLOOR SHEATHING SHALL BE 3/4", STRUCTURAL GRADE I CD (48/24) OVER WOOD JOISTS. PROVIDE ADEQUATE BLOCKING, TONGUE AND GROOVED EDGES.
- PLYWOOD ROOF SHEATHING SHALL BE 1/2" STRUCTURAL GRADE I CD (48/24) OVER WOOD JOISTS. PROVIDE ADEQUATE BLOCKING AND PLYCLIPS (2 FOR 48' SPAN).
- PLACE PLYWOOD PANELS WITH LONG DIMENSION RUNNING PERPENDICULAR TO JOISTS WITH END JOINTS STAGGERED 1/2 PANEL. USE 6d NAILS SPACED AT 6" O.C. AT END JOINTS OF PANEL AND AT WALL CONNECTIONS. FIELD NAILING OF INTERMEDIATE SUPPORTS SHALL BE AT 10" O.C.
- ALL WOOD FRAMING SHALL BE INSTALLED, BLOCKED, AND FASTENED FOLLOWING THE PROVISIONS OF THE 2015 INTERNATIONAL RESIDENTIAL CODE.

ELECTRICAL SYMBOLS		MOTORS AND CONTROLS	RACEWAYS AND WIRING	MISCELLANEOUS
<p>P</p> <p>POLE, PUMP PHASE PANEL POINT OF SALE POWER POLE PAIR POWER</p> <p>Q</p> <p>QUANTITY</p> <p>R</p> <p>EXISTING TO BE REMOVED RETURN AIR REFLECTED CEILING PLAN RECEPTACLE REFERENCE, REFER RECEPTACLE REVISION, REVISE RIGID GALVANIZED STEEL ROOFTOP UNIT</p> <p>S</p> <p>SCHEDULE SECONDARY SECTION SQUARE FEET SPECIFICATION SPEAKER SINGLE-POLE, DOUBLE-THROW SINGLE-POLE, SINGLE-THROW SQUARE SWITCHBOARD</p> <p>T</p> <p>TEMPERATURE CONTROL TELEPHONE TRANSFER FAN TWIST-LOCK TOP OF CURB TOP OF STEEL CHILD TAMPER PROOF DEVICE THERMOSTAT TELEPHONE TERMINAL BOARD TELEPHONE TERMINAL CABINET TERMINAL UNIT TELEVISION TRANSIENT VOLTAGE SURGE SUPPRESSOR TYPICAL</p> <p>U</p> <p>UNDERGROUND UNIT HEATER UNDERWRITERS LABORATORIES, INC. UNLESS NOTED OTHERWISE UNINTERRUPTIBLE POWER SYSTEM</p> <p>V</p> <p>VOLT VOLT-AMPERE VARIABLE AIR VOLUME VOLUME CONTROL VERTICAL VARIABLE FREQUENCY DRIVE VACUUM PUMP VOLT METER</p> <p>W</p> <p>WATT, WIRE, WIDTH WIREGUARD WITH WITHOUT WEATHERPROOF WATER SOFTENER WATERTIGHT, WEIGHT WELDED WIRE FABRIC</p> <p>X</p> <p>TRANSFORMER</p> <p>Z</p> <p>ZONE</p>	<p>MOTORS AND CONTROLS</p> <p>Ⓢ SINGLE OR THREE PHASE MOTOR NUMBER INDICATES HORSE POWER</p> <p>☐ ELECTRIC DUCT HEATER</p> <p>☐ DISCONNECT (SAFETY) SWITCH "200/3/150" DENOTES AMPERES/POLE/FUSE, "NF" DENOTES NON-FUSED "N3R" DENOTES NEMA 3R</p> <p>☑ ENCLOSED CIRCUIT BREAKER- "200/3/150" DENOTES AMPERES/POLE/TRIP.</p> <p>☑ MOTOR STARTER FURNISHED BY DIVISION 15 AND INSTALLED BY DIVISION 16.</p> <p>☑ COMBINATION DISCONNECT (SAFETY) SWITCH AND MOTOR STARTER, "30/3/15/40" DENOTES AMPERES/POLES/FUSE/ STARTER SIZE, "NF" DENOTES NON-FUSED, FURNISHED BY DIVISION 15 AND INSTALLED BY DIVISION 16.</p> <p>☑ VFD VARIABLE FREQUENCY DRIVE PROVIDED BY DIVISION 15 AND INSTALLED BY DIVISION 16.</p> <p>☑ EPO EMERGENCY POWER OFF BUTTON.</p> <p>RECEPTACLES AND OUTLETS</p> <p>ALL RECEPTACLES SHALL BE MOUNTED 16" ABOVE FINISHED FLOOR TO CENTER OF DEVICE UNLESS NOTED OTHERWISE.</p> <p>Ⓛ SIMPLEX WALL RECEPTACLE, NEMA 5-20R, 20A, 125V.</p> <p>Ⓛ DUPLEX WALL RECEPTACLE, NEMA 5-20R, 20A, 125V.</p> <p>"EM" DENOTES EMERGENCY CIRCUIT, PROVIDE RED RECEPTACLE AND FACEPLATE. "GFI" DENOTES GROUND FAULT INTERRUPTER, "WP" DENOTES WEATHERPROOF, "IG" DENOTES ISOLATED GROUND, "TP" DENOTES SAFETY TYPE, (TAMPER PROOF) "DR" DENOTES DROPPED RECEPTACLE, "AC" DENOTES ABOVE COUNTER MOUNTING, SEE ARCHITECTURAL PLANS FOR EXACT MOUNTING HEIGHT.</p> <p>Ⓛ DUPLEX WALL RECEPTACLE ON EMERGENCY CIRCUIT, RED COLOR.</p> <p>Ⓛ DUPLEX WALL RECEPTACLE ON A CIRCUIT DEDICATED TO DATA PROCESSING, GRAY COLOR. PROVIDE ISOLATED GROUND TYPE RECEPTACLES WHERE NOTED.</p> <p>Ⓛ SPLIT WIRED RECEPTACLE. TOP RECEPTACLE SHALL BE SWITCHED ACCORDING TO PLANS, AND BOTTOM SHALL REMAIN UNSWITCHED.</p> <p>Ⓛ FOURPLEX (DOUBLE DUPLEX) WALL RECEPTACLE. NEMA 5-20R, 20A, 125V.</p> <p>Ⓛ FOURPLEX WALL RECEPTACLE ON EMERGENCY CIRCUIT, RED COLOR.</p> <p>Ⓛ SPECIAL RECEPTACLE, NEMA CONFIGURATION AS NOTED.</p> <p>Ⓛ FLUSH ELECTRICAL FLOOR OUTLET, "P" DENOTES POKE-THRU. "DT" INDICATES DUPLEX RECEPTACLE, "R" INDICATES RED RECEPTACLE ON EMERGENCY POWER</p> <p>----- MULTI-OUTLET SURFACE RACEWAY. SEE ARCHITECTURAL DRAWINGS FOR EXACT MOUNTING HEIGHTS.</p> <p>☐ JUNCTION BOX (SQUARE)</p> <p>☐ JUNCTION BOX</p> <p>☐ DUPLEX RECEPTACLE WITH HOMERUN</p> <p>☐ DUPLEX RECEPTACLE (PEDESTAL MOUNTED)</p> <p>☐ TWO-GANG FLOOR OUTLET</p> <p>☐ THREE-GANG FLOOR OUTLET</p> <p>☐ POWER POLE</p> <p>☐ DIRECT CONNECTION TO EQUIPMENT</p> <p>☐ PULL BOX (OVER 4" SQUARE)</p> <p>☐ TENANT LIGHTING JUNCTION BOX</p> <p>☐ TENANT POWER JUNCTION BOX</p> <p>☐ CLOCK RECEPTACLE TO BE MOUNTED 12" BELOW FINISHED CEILING. (2) DENOTES DOUBLE SIDED CLOCK. (1) SINGLE SIDED. NO NUMBER MEANS CLOCK TO MOUNTED WITH BACK SURFACE MOUNTED ON WALL.</p> <p>LIGHTING</p> <p>LETTER(S) DENOTE TYPE- SEE LIGHTING FIXTURE SCHEDULE FOR ADDITIONAL INFORMATION.</p> <p>☐ 2' X 4' FLUORESCENT LIGHTING FIXTURE.</p> <p>☐ 2' X 2' FLUORESCENT LIGHTING FIXTURE.</p> <p>☐ 1' X 4' FLUORESCENT LIGHTING FIXTURE.</p> <p>☐ 1' X 2' FLUORESCENT LIGHTING FIXTURE.</p> <p>☐ 1' X 1' FLUORESCENT LIGHTING FIXTURE.</p> <p>☐ FLUORESCENT STRIP LIGHTING FIXTURES.</p> <p>☐ STAGGERED STRIP LIGHTING FIXTURE.</p> <p>☐ INCANDESCENT, FLUORESCENT OR HID DOWNLIGHT FIXTURE.</p> <p>☐ WALL MOUNTED INCANDESCENT, FLUORESCENT OR HID FIXTURE.</p> <p>☐ TRACK LIGHTING FIXTURE, MOUNTED AS SHOWN ON LIGHTING FIXTURE SCHEDULE.</p> <p>☐ CEILING MOUNTED EXIT SIGN; ARROWS AS INDICATED. SHADED AREA DENOTES FACE.</p> <p>☐ WALL MOUNTED EXIT SIGN; ARROWS AS INDICATED. SHADED AREA DENOTES FACE.</p> <p>☐ EMERGENCY WALL MOUNTED LIGHTING FIXTURE. BATTERY OPERATED UNLESS NOTED OTHERWISE.</p> <p>☐ HID SECURITY WALL PACK</p>	<p>RACEWAYS AND WIRING</p> <p>===== CAP AND STAKE</p> <p>----- CONDUIT CONCEALED IN WALL OR CEILING</p> <p>----- CONDUIT UNDERSLAB OR UNDERGROUND</p> <p>EM EMERGENCY CONDUIT</p> <p>----- EXPOSED CONDUIT</p> <p>----- DB----- UNDERGROUND CONDUIT, "DB" DENOTES DUCTBANK ENCASED IN CONCRETE</p> <p>OHE OVERHEAD ELECTRIC PRIMARY UTILITY POWER LINE</p> <p>----- CONDUIT TURNED UP</p> <p>----- CONDUIT TURNED DOWN</p> <p>===== HASH MARKS INDICATE NUMBER OF CONDUCTORS. LEFT TO RIGHT: PHASE/NEUTRAL/SWITCH LEG/GROUND/ISOLATED GROUND. NO HASH MARKS INDICATES 2# 12, PLUS GROUND, UNLESS NOTED OTHERWISE.</p> <p>1LA-2,4 HOMERUN TO PANEL WITH CIRCUIT NUMBER(S) AS INDICATED.</p> <p>(ON)1LA-6 PARTIAL CIRCUIT HOMERUN TO PANEL.</p> <p>===== COMMUNICATIONS CONDUIT OR CABLE: "C" DENOTES MASTER CLOCK, "CA" DENOTES MASTER CASH REGISTER, "CR" DENOTES CASH REGISTER, "D" DENOTES DATA, "FA" DENOTES FIRE ALARM, "I" DENOTES INTERCOM, "OHE" DENOTES OVERHEAD ELECTRICAL LINE, "PA" DENOTES PAGING, "S" DENOTES SECURITY, "T" DENOTES TELEPHONE, "V" DENOTES VIDEO.</p> <p>===== TELECOMMUNICATIONS CABLE TRAY TO BE CONCEALED ABOVE ACCESSIBLE CEILING.</p> <p>ELECTRICAL EQUIPMENT</p> <p>☐ DISTRIBUTION PANEL</p> <p>☐ SWITCHBOARD, MAIN DISTRIBUTION PANEL OR MOTOR CONTROL CENTER</p> <p>☐ PANELBOARD (FLUSH/SURFACE MOUNT)</p> <p>☐ FLOOR MOUNTED DRY-TYPE TRANSFORMER</p> <p>COMMUNICATIONS</p> <p>ALL RECEPTACLES SHALL BE MOUNTED 16" ABOVE FINISHED FLOOR TO CENTER OF DEVICE UNLESS NOTED OTHERWISE.</p> <p>THE FOLLOWING NOTATIONS REFER TO ALL COMMUNICATIONS OUTLETS: "FAX" DENOTES OUTLET DEDICATED FOR A FAX, "W" DENOTES WALL PHONE SHALL BE MOUNTED AT 42" A.F.F., "PAY" DENOTES PAY PHONE SHALL BE MOUNTED 42" A.F.F.</p> <p>◀ TELEPHONE WALL OUTLET.</p> <p>◀ DATA WALL OUTLET.</p> <p>◀ VOICE/DATA OUTLET</p> <p>☐ FLUSH TELEPHONE FLOOR OUTLET, "P" DENOTES POKE-THRU</p> <p>☐ FLUSH DATA FLOOR OUTLET, "P" DENOTES POKE-THRU</p> <p>☐ FLUSH VOICE/DATA FLOOR OUTLET, "P" DENOTES POKE-THRU</p> <p>HDS SCHOOL INTERCOMMUNICATION SYSTEM DESKSET.</p> <p>HHS SCHOOL INTERCOMMUNICATION SYSTEM HANDSET.</p> <p>HTV TELEVISION OUTLET 1 GANG JUNCTION BOX WITH ONE FEMALE COAX BARREL CONNECTOR MOUNTED IN SINGLE GANG S.S. COVER PLATE.</p> <p>MPW MICROPHONE FLOOR OUTLET, "W" INDICATES WALL MOUNTED</p> <p>SCVC CEILING MOUNTED SPEAKER. "VC" INDICATES VOLUME CONTROL ON SPEAKER.</p> <p>HS WALL MOUNTED SPEAKER.</p> <p>DRAWING/DETAIL REFERENCE KEY</p> <p>REFER TO DRAWING/DETAIL NUMBER</p> <p>1/E3-2 SHEET NUMBER</p> <p>GENERAL NOTES</p> <p>A. NOT ALL SYMBOLS SHOWN ON THIS SYMBOL LIST ARE USED IN THE CONTRACT DOCUMENTS.</p>	<p>MISCELLANEOUS</p> <p>☐ F SHADED SYMBOLS INDICATE EXISTING DEVICES TO REMAIN, UNLESS OTHERWISE NOTED.</p> <p>--- INDICATES WALL-MOUNTED WHEN ATTACHED TO ANY SYMBOL</p> <p>① DRAWING NOTE REFERENCE</p> <p>① STARTER/DISCONNECT SCHEDULE REFERENCE</p> <p>① FEEDER SCHEDULE REFERENCE</p> <p>LC LIGHTING CONTACTOR</p> <p>TS TIME SWITCH</p> <p>PC PHOTOCELL</p> <p>HB PUSH BUTTON</p> <p>TC TIMECLOCK</p> <p>R RELAY</p> <p>FIRE ALARM</p> <p>W WATER FLOW SWITCH</p> <p>SP SUPERVISORY SWITCH</p> <p>S_D SMOKE DETECTOR - "D" INDICATES DUCT TYPE</p> <p>H HEAT DETECTOR</p> <p>BT BEAM DETECTOR TRANSMITTER, HIGH IN CEILING WALL DIRECT LINE OF SIGHT.</p> <p>BR BEAM DETECTOR RECEIVER, HIGH IN CEILING WALL DIRECT LINE OF SIGHT.</p> <p>SK SPEAKER/VISUAL +80" A.F.F. - 15/75cd UNLESS NOTED OTHERWISE.</p> <p>D MAGNETIC DOOR HOLDER</p> <p>R AUXILIARY CONTROL RELAY</p> <p>F FIRE ALARM PULL STATION +42" AFF</p> <p>F FIREMAN'S TELEPHONE JACK +42" AFF</p> <p>FV AUDIO VISUAL FIRE ALARM HORN +80" AFF</p> <p>HV AUDIO FIRE ALARM HORN +80" AFF</p> <p>V VISUAL FIRE ALARM (STROBE) +80" AFF</p> <p>FACP FIRE ALARM CONTROL PANEL</p> <p>ANN REMOTE FIRE ALARM ANNUNCIATOR PANEL</p> <p>VEP FIRE ALARM VOICE EVACUATION PANEL</p> <p>HS FIRE ALARM SPEAKER / WALL MOUNTED</p> <p>MS MINI AUDIO FIRE ALARM HORN +80" AFF</p> <p>MSV MINI AUDIO/VISUAL FIRE ALARM HORN +80" AFF</p> <p>HFH FIRE FIGHTER HANDSET</p> <p>RPS REMOTE POWER SUPPLY FOR AUDIO/VISUAL FIRE ALARM DEVICES.</p> <p>SD FIRE SMOKE DAMPER</p> <p>V VISUAL FIRE ALARM STROBE, CEILING MOUNTED</p> <p>FV AUDIO VISUAL FIRE ALARM HORN-CEILING MOUNTED</p> <p>S FIRE ALARM SPEAKER / VISUAL - CEILING MOUNTED</p> <p>SWITCHES</p> <p>ALL SWITCHES SHALL BE MOUNTED AT 42" ABOVE FINISHED FLOOR TO CENTER OF DEVICE UNLESS NOTED OTHERWISE.</p> <p>☐ SWITCH, SPST, 20A, 120/277V.</p> <p>☐ SWITCH, 20A, 120/277V: "2" DENOTES DPST, "3" DENOTES THREE-WAY, "4" DENOTES FOUR-WAY, "K" DENOTES KEY SWITCH, "P" DENOTES PILOT LIGHT, "ST" DENOTES SPRING WOUND TIMER, "R" DENOTES RED "F" FAN SPEED CONTROLLER "OC" OCCUPANCY SENSOR "L" DENOTES LOCKING SWITCH</p> <p>☐ SWITCH, SPDT, CENTER OFF, MOMENTARY CONTACT.</p> <p>☐ DIMMER CONTROL SWITCH, 600 WATT UNLESS OTHERWISE NOTED.</p> <p>☐ THREE-WAY KEY SWITCH, 20A, 120/277V.</p> <p>☐ WALL MOUNTED SWITCH TO CONTROL MOTORIZED PROJECTION SCREENS.</p> <p>☐ MOTOR RATED SWITCH WITH THERMAL OVERLOADS</p> <p>☐ MOTOR RATED TOGGLE SWITCH</p> <p>☐ CEILING MOUNTED OCCUPANCY SENSOR</p>	

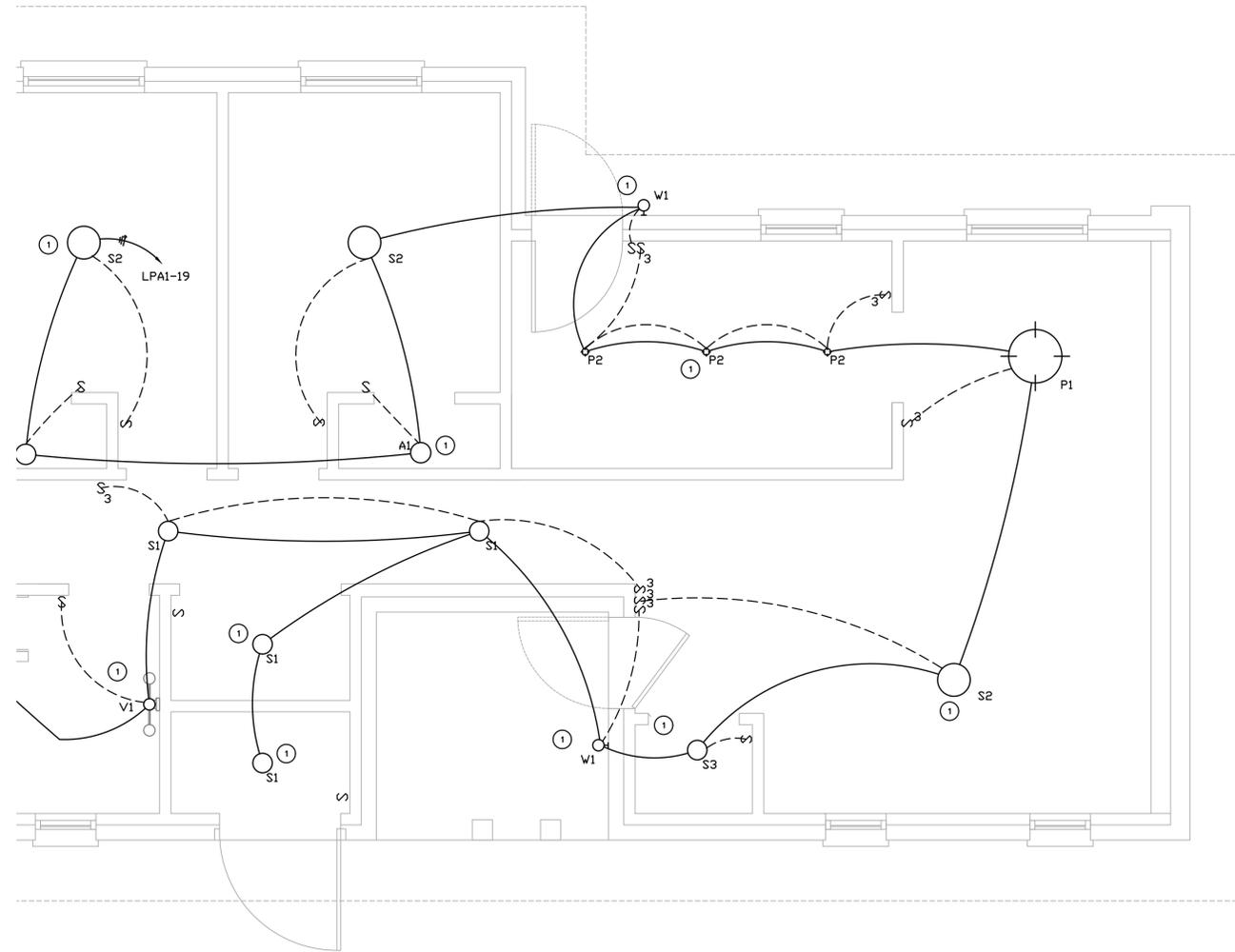

1 LIGHTING PLAN - UNIT 942
3/8" = 1'-0"

**General Notes Lighting Sheets:
(Applies to all Lighting Sheets)**

- A. WHEN LOCATING SYSTEMS NEXT TO DOORS, LOCATE 8 INCHES OFF DOOR JAMB TO CENTER OF DEVICE. WHEN MULTIPLE DEVICES ARE TOGETHER, STACK BUT NO MORE THAN 72 INCHES AFF. COORDINATE SWITCH LOCATIONS IN ROOMS WITH ARCHITECT AND OTHER DEVICES (THERMOSTATS, FIRE ALARM, AND CALL BUTTONS).
- B. MINIMUM CIRCUIT SIZE IS 2 #12 AND 1 #12 GROUND IN 3/4" CONDUIT. MAXIMUM FIXTURE WHIP LENGTH FROM ANY J-BOX 6 FEET. LIGHTING CIRCUITS JOINTS SHALL BE MADE UP IN OVERHEAD J-BOXES SECURED TO STRUCTURE WITH LIGHTING WHIPS FROM THE J-BOXES. FIXTURES DESIGNED TO BE QUICK-CLIPPED TOGETHER SHALL BE CONNECTED AS PER MANUFACTURER.
- C. COORDINATE LIGHT LOCATIONS WITH OTHER CEILING ITEMS OR JOIST ITEMS PRIOR TO INSTALLATION. LIGHT LOCATIONS TAKE PRECEDENCE OVER AIR DEVICES.
- D. PROVIDE SECONDARY SUPPORT WIRES FROM ALL FOUR (4) CORNERS OF THE LAY-IN FIXTURES TO THE STRUCTURE ABOVE. DO NOT SUPPORT FIXTURES FROM CEILING GRID WIRE SUPPORTS, PIPING, CONDUIT, SIDE WALLS, OR MECHANICAL EQUIPMENT. CEILING SPECIFICATIONS DO NOT SUPERCEDE THIS REQUIREMENT.
- E. PROVIDE INTEGRAL BATTERY BACK-UP W/INTEGRAL BATTERY BACK-UP & TEST SWITCH FOR ALL FIXTURES WITH AN "E" SUFFIX.
- F. FIRESTOP ALL CONDUIT PENETRATIONS IN RATED WALLS. SEE ARCHITECTURAL FOR WALL RATINGS. THE CONTRACTOR SHALL BE RESPONSIBLE FOR DAMAGE TO SHEET ROCK AND REPAIR. PROVIDE FIRE-RATED SLEEVES IN ALL FLOOR PENETRATIONS.
- G. CONTRACTOR TO VERIFY FIXTURE VOLTAGE PRIOR TO INSTALLING ANY RELOCATED FIXTURE. COORDINATE WITH RCP FOR FIXTURE LOCATIONS.
- H. ALL ROOMS AND HALLWAYS SHALL HAVE SWITCHES WHETHER SHOWN ON PLAN OR NOT. ALL SPACES WITH MORE THAN ONE FIXTURE SHALL HAVE DUAL SWITCHING UNLESS OTHERWISE NOTED. ALL HALLWAYS SHALL HAVE AT LEAST (2) 3-WAY SWITCHES.
- I. SMOKE DETECTORS AND CARBON MONOXIDE DETECTORS SHALL BE HARDWIRED AND CONNECTED IN SERIES. PROVIDE 120V, 20A CIRCUIT FROM PANEL SPARE.

Keyed Notes:

- 1 COORDINATE WITH OWNER FOR FIXTURE SELECTIONS. TYPICAL OF ALL FIXTURES.



04-12-18

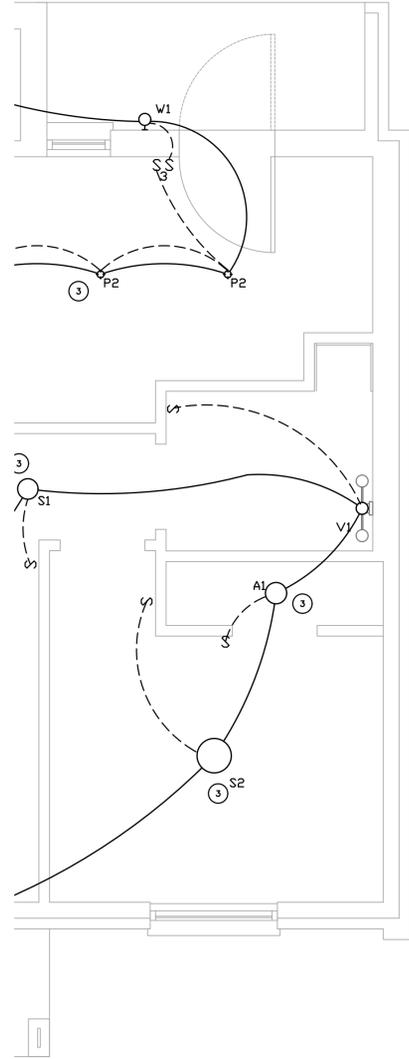

1 FLOOR - UNIT 1818

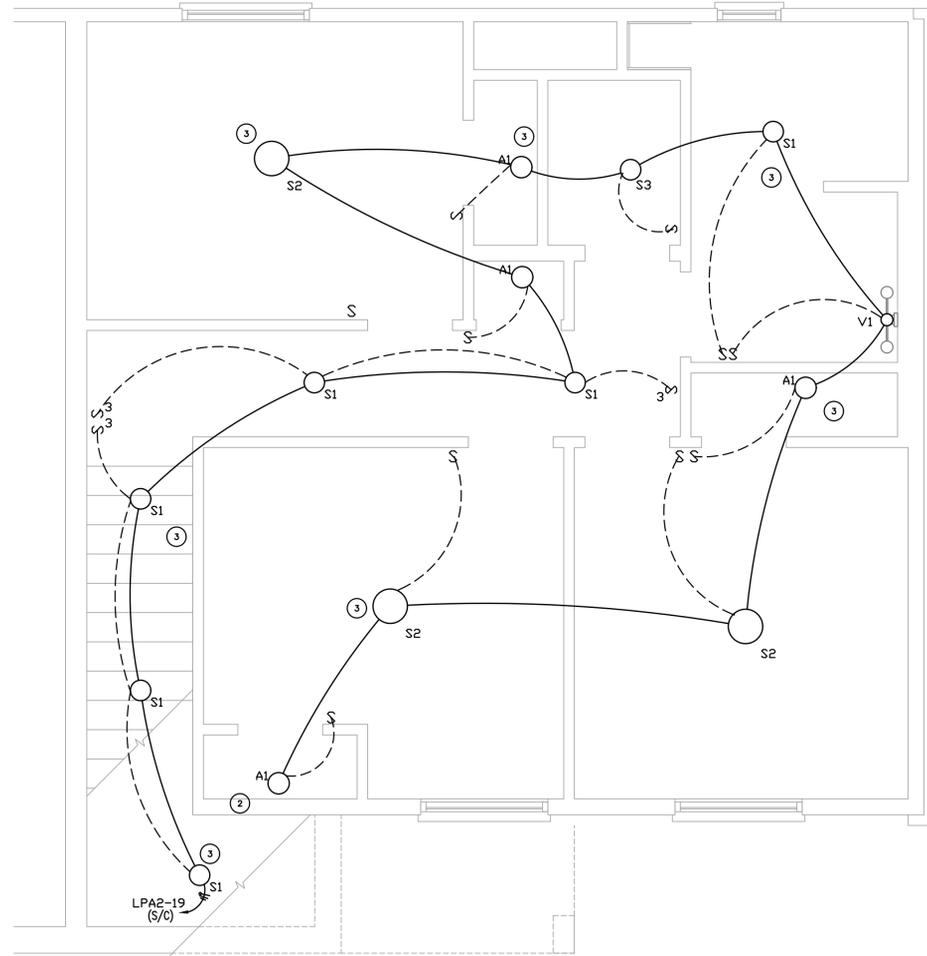

2 LIGHTING PLAN 2ND FLOOR - UNIT 1818
3/8" = 1'-0"

Keyed Notes:

- 1 REFER TO 2ND FLOOR LIGHTING PLAN FOR CONTINUATION.
- 2 REFER TO 1ST FLOOR LIGHTING PLAN FOR CONTINUATION.
- 3 COORDINATE WITH OWNER FOR FIXTURE SELECTIONS, TYPICAL OF ALL FIXTURES.



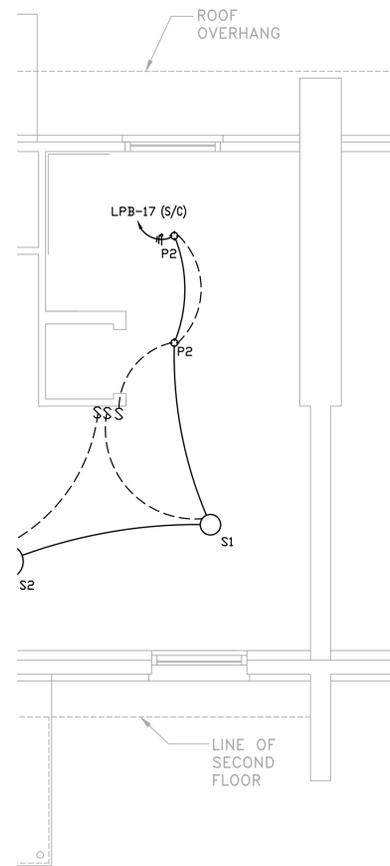

1 FLOOR - UNIT 103 & 2404

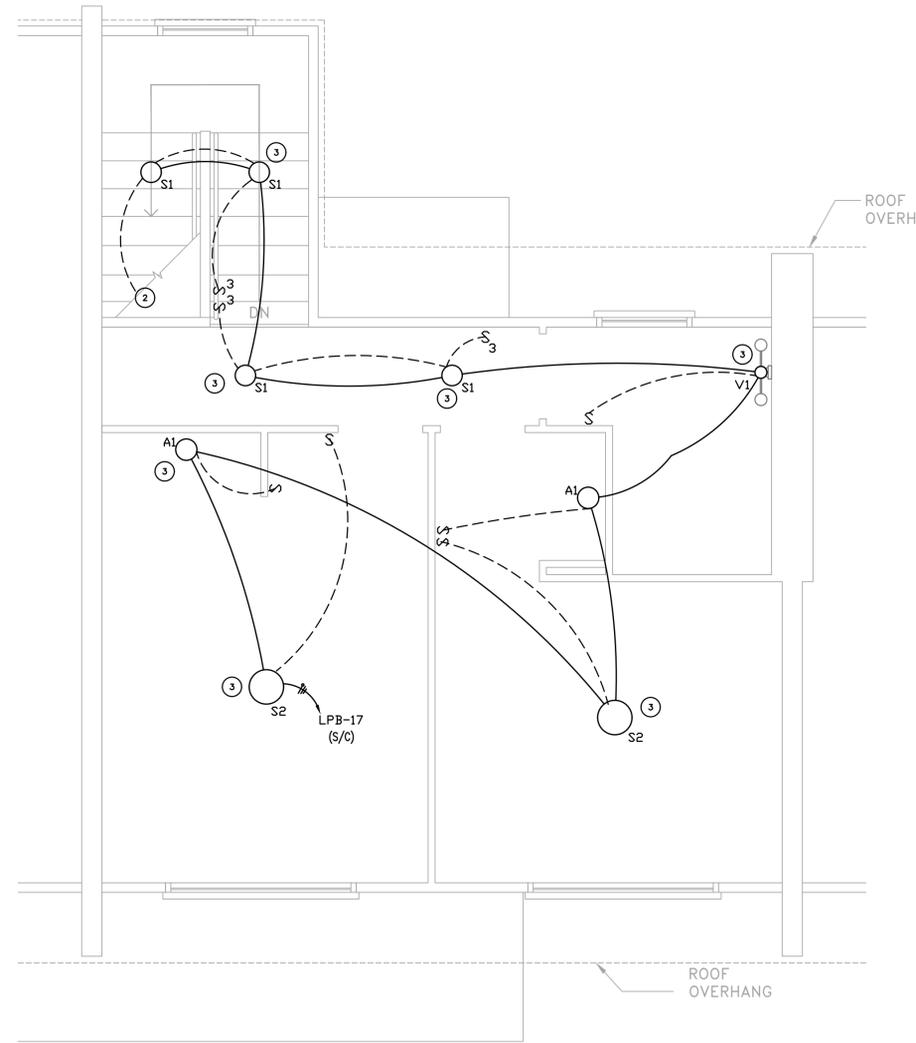

2 LIGHTING PLAN 2ND FLOOR - UNIT 103 & 2404
3/8" = 1'-0"

Keyed Notes:

- 1 REFER TO 2ND FLOOR LIGHTING PLAN FOR CONTINUATION.
- 2 REFER TO 1ST FLOOR LIGHTING PLAN FOR CONTINUATION.
- 3 COORDINATE WITH OWNER FOR FIXTURE SELECTIONS. TYPICAL OF ALL FIXTURES.

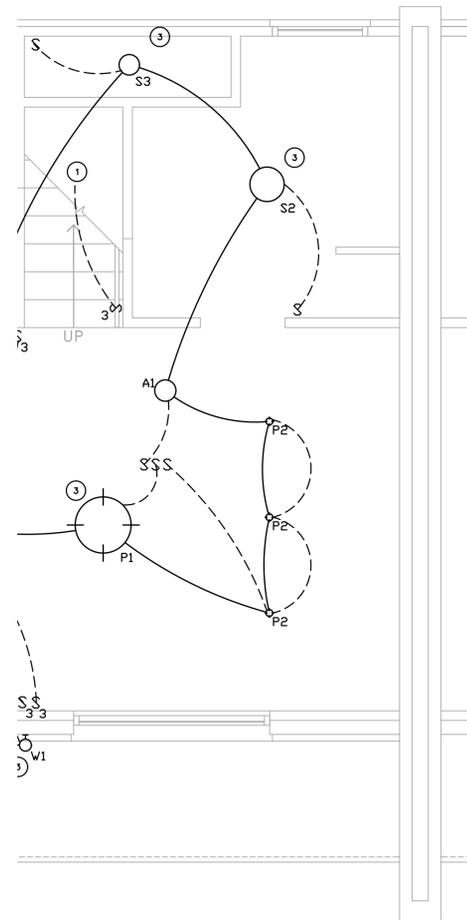

1 FLOOR - UNIT 1523 & 3023

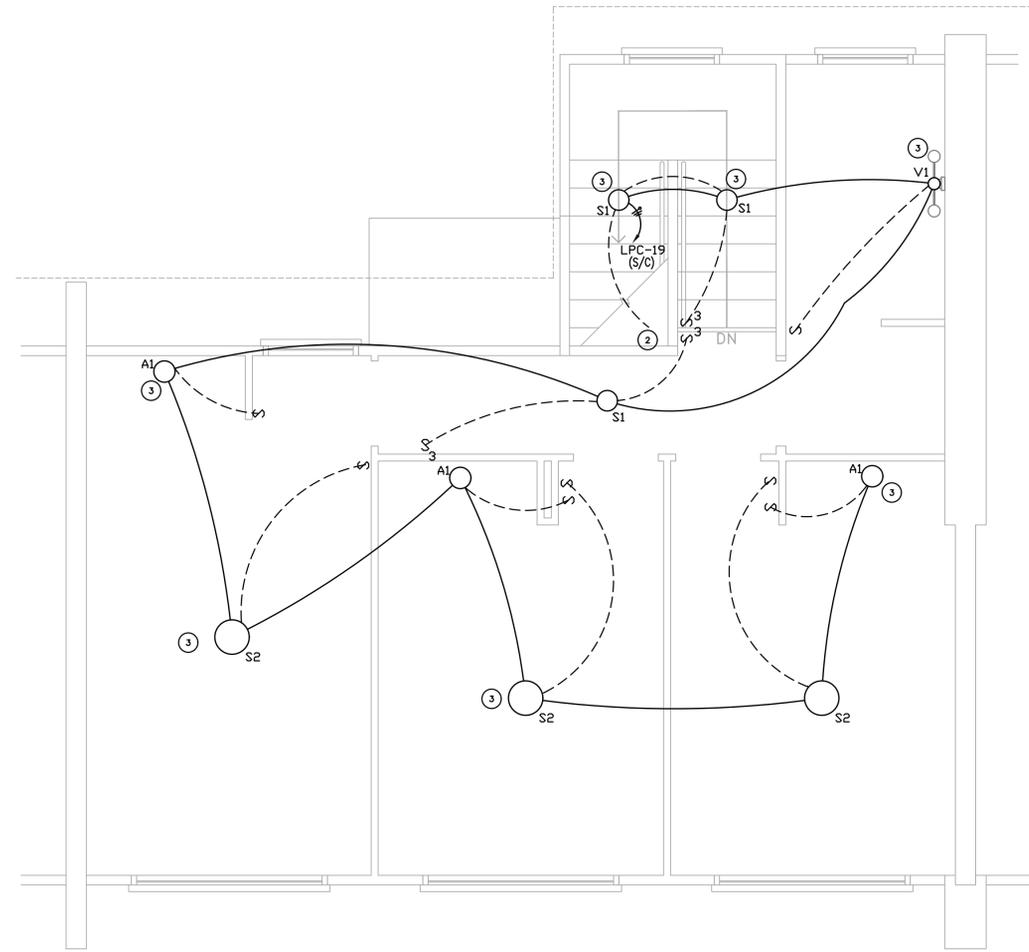

2 LIGHTING PLAN 2ND FLOOR - UNIT 1523 & 3023
3/8" = 1'-0"

- Keyed Notes:**
- 1 REFER TO 2ND FLOOR LIGHTING PLAN FOR CONTINUATION.
 - 2 REFER TO 1ST FLOOR LIGHTING PLAN FOR CONTINUATION.
 - 3 COORDINATE WITH OWNER FOR FIXTURE SELECTIONS. TYPICAL OF ALL FIXTURES.

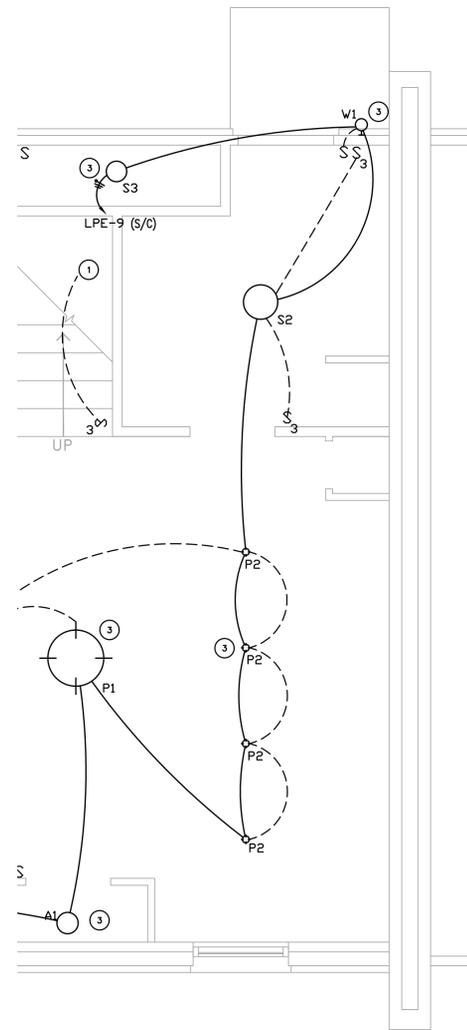

1 FLOOR - UNIT 1501

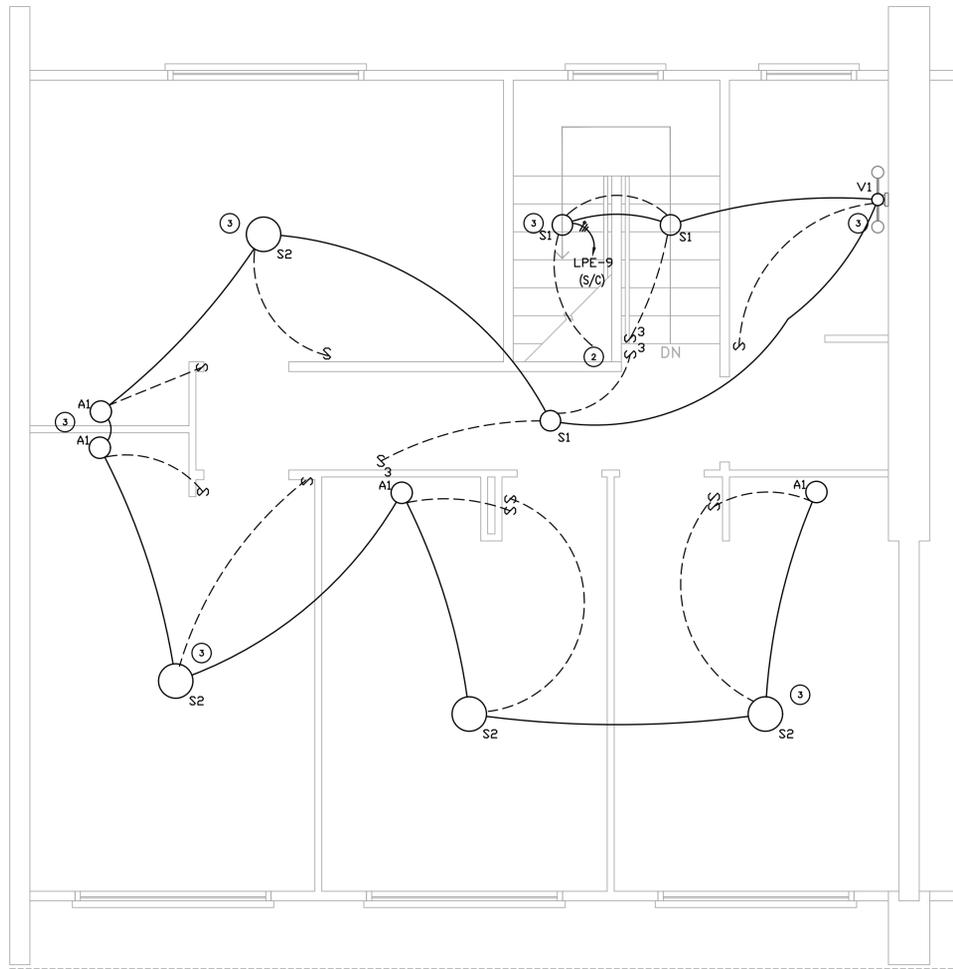

2 LIGHTING PLAN 2ND FLOOR - UNIT 1501
3/8" = 1'-0"

Keyed Notes:

- 1 REFER TO 2ND FLOOR LIGHTING PLAN FOR CONTINUATION.
- 2 REFER TO 1ST FLOOR LIGHTING PLAN FOR CONTINUATION.
- 3 COORDINATE WITH OWNER FOR FIXTURE SELECTIONS. TYPICAL OF ALL FIXTURES.



**General Notes Power Sheets:
(Applies to all Power Sheets)**

- A. SEE OTHER PLANS FOR ADDITIONAL DEVICES. SOME POWER CIRCUITING MAY BE ON OTHER PLANS. COORDINATE THE LOCATIONS OF DATA/CATV JACKS WITH THE RECEPTACLES. MOUNT ADJACENT TO EACH OTHER.
- B. WHEN LOCATING SYSTEMS NEXT TO DOORS, LOCATE 8 INCHES OFF DOOR JAMB TO CENTER OF DEVICE. WHEN MULTIPLE DEVICES ARE TOGETHER, STACK BUT NO MORE THAN 72 INCHES AFF.
- C. MINIMUM CIRCUIT SIZE IS 2 #12 AND 1 #12 GROUND IN 3/4" CONDUIT FOR INDIVIDUAL CIRCUITS, 3/4" CONDUIT FOR MULTIPLE CIRCUITS. ALL CONDUCTORS SHALL BE 75 DEGREE (MINIMUM) COPPER THHN, COLOR CODED AS PER NEC AND LOCAL AMENDMENTS WITH SIZE, TEMPERATURE, AND VOLTAGE PERMANENTLY PRINTED ON THE JACKET. ALL JOINTS SHALL BE MADE UP USING SELF LOCKING, TWIST-ON, COLOR CODED, SQUARE WIRE SPRING GRAB, LONG SKIRT, WIRE CONNECTORS WITH SWEPT WINGS.
- D. PROVIDE #10 AWG MIN NEUTRAL FOR ALL MULTIWIRE BRANCH CIRCUITS AND PROVIDE HANDLE TIES FOR CIRCUIT BREAKERS AS REQUIRED BY NEC 210.4
- E. CONDUCTOR SIZES INDICATED ASSUME NO MORE THAN (3) SINGLE POLE BRANCH CIRCUITS IN EACH CONDUIT. IT SHALL BE THE CONTRACTOR'S RESPONSIBILITY TO DE-RATE CONDUCTORS PER NEC TABLE 310.15(B)(2)(g) FOR CONDUITS WITH MORE THAN (3) CURRENT "CARRYING CONDUCTORS". THE NEUTRAL CONDUCTOR SHALL BE CONSIDERED "CURRENT CARRYING" FOR ALL BRANCH CIRCUITS SERVING MORE THAN (4) COMPUTERS.
- F. COORDINATE RECEPTACLE LOCATIONS WITH MILLWORK AND COUNTERTOPS. DO NOT LOCATE RECEPTACLES BEHIND DRAWERS OR HIDDEN IN MILLWORK UNLESS SPECIFICALLY DIRECTED BY OWNER/ARCHITECT. REVIEW ARCHITECTURAL ELEVATIONS PRIOR TO RECEPTACLE ROUGH-INS. SEE ARCH. ELEVATIONS IN BREAKROOMS FOR APPLIANCES AND RECEPTACLE MOUNTING LOCATIONS.
- G. MOUNT RECEPTACLES 18" AFF. 6" ABOVE BACKSPLASH AT COUNTERTOPS, 48" IN TOILET ROOMS. AT EQUIPMENT ROUGH-IN LOCATIONS FOR APPLIANCES, AND 96" FOR TV'S. PROVIDE GFI RECEPTACLES AT/LOCATED ALL SINKS, ROOFTOP RECEPTACLES, KITCHEN RECEPTACLES, BATHROOM/TOLIT ROOMS, EXTERIOR RECEPTACLES, AND UNDERCOUNTER EQUIPMENT. ALSO, ALL RECEPTACLES SERVING DRINKING FOUNTAINS SHALL HAVE GFI.
- H. ALL RECEPTACLES NOT DEDICATED TO EQUIPMENT WITHIN 6' OF SINK, MOP SINK, DRINKING FOUNTAIN OR OTHER USER WATER SOURCE SHALL BE GFI PROTECTED.
- I. ALL RECEPTACLES IN KITCHENS SHALL BE GFI PROTECTED.
- J. ALL EQUIPMENT SHALL HAVE A LOCAL DISCONNECTING MEANS, EITHER CORDED PLUG AND RECEPTACLE OR SWITCHED DISCONNECT. VERIFY FROM EQUIPMENT SUBMITTED OR RELOCATED IF DIRECT CONNECT OR RECEPTACLE. IF DIRECT CONNECT, PROVIDE SWITCH AS PER NEC OTHERWISE, PROVIDE RECEPTACLE, CORD PLUG AS REQUIRED BY EQUIPMENT SUBMITTAL.
- K. FIRESTOP ALL CONDUIT PENETRATIONS IN RATED WALLS. SEE ARCHITECTURAL FOR WALL RATINGS. CONTRACTOR SHALL BE RESPONSIBLE FOR DAMAGE TO SHEET ROCK AND REPAIR.
- M. PROVIDE FIRE RATED SLEEVES IN ALL FLOOR PENETRATIONS.
- N. PROVIDE ARC FAULT PROTECTION AND TAMPER PROOF RECEPTACLES FOR ALL 120V 15 AND 20 AMP DWELLING UNIT BRANCH CIRCUITS THAT SUPPLY OUTLETS IN FAMILY ROOMS, DINING ROOMS, LIVING ROOMS, PARLORS, LIBRARIES, DENS, BEDROOMS, SUNROOMS, RECREATIONS ROOMS, CLOSETS, HALLWAYS AND SIMILAR AREAS PER NEC210.12(B).
- O. PROVIDE A MINIMUM OF (5) SPARE 20A/1P BREAKERS AND (3) 20A/1P SPACES IN EACH PANEL WHETHER SHOWN ON SCHEDULE OR NOT.
- P. SMOKE DETECTORS AND CARBON MONOXIDE DETECTORS SHALL BE HARDWIRED AND CONNECTED IN SERIES. PROVIDE 120V, 20A CIRCUIT FROM PANEL SPARE.

Keyed Notes:

- ① COORDINATE LOCATION OF HEATING EQUIPMENT WITH ARCHITECT/OWNER. PROVIDE FLUE AND WALL CAPS AS REQUIRED.
- ② COORDINATE LOCATION OF TENANT PANEL WITH ARCHITECT PRIOR TO ROUGH-IN.
- ③ PROVIDE DEDICATED 20A, 120V CIRCUIT TO TENANT PANEL 20A/1P FOR POWER TO NEW CEILING MOUNTED HEATER. PROVIDE AND INSTALL A SURFACE MOUNT CEILING HEATER EQUAL TO BROAD NUTONE - 120V, 1250 WATT. PROVIDE MANUAL ROTARY TIMER MOUNTED ADJACENT TO LIGHT SWITCH FOR CONTROL OF HEATER.
- ④ COORDINATE LOCATION OF ELECTRIC CLOTHES DRYER WITH ARCHITECT.
- ⑤ PROVIDE JBOX FOR CONNECTION TO EXHAUST VENT HOOD. CONNECT TO 20A/1P SPARE IN UNIT PANEL.

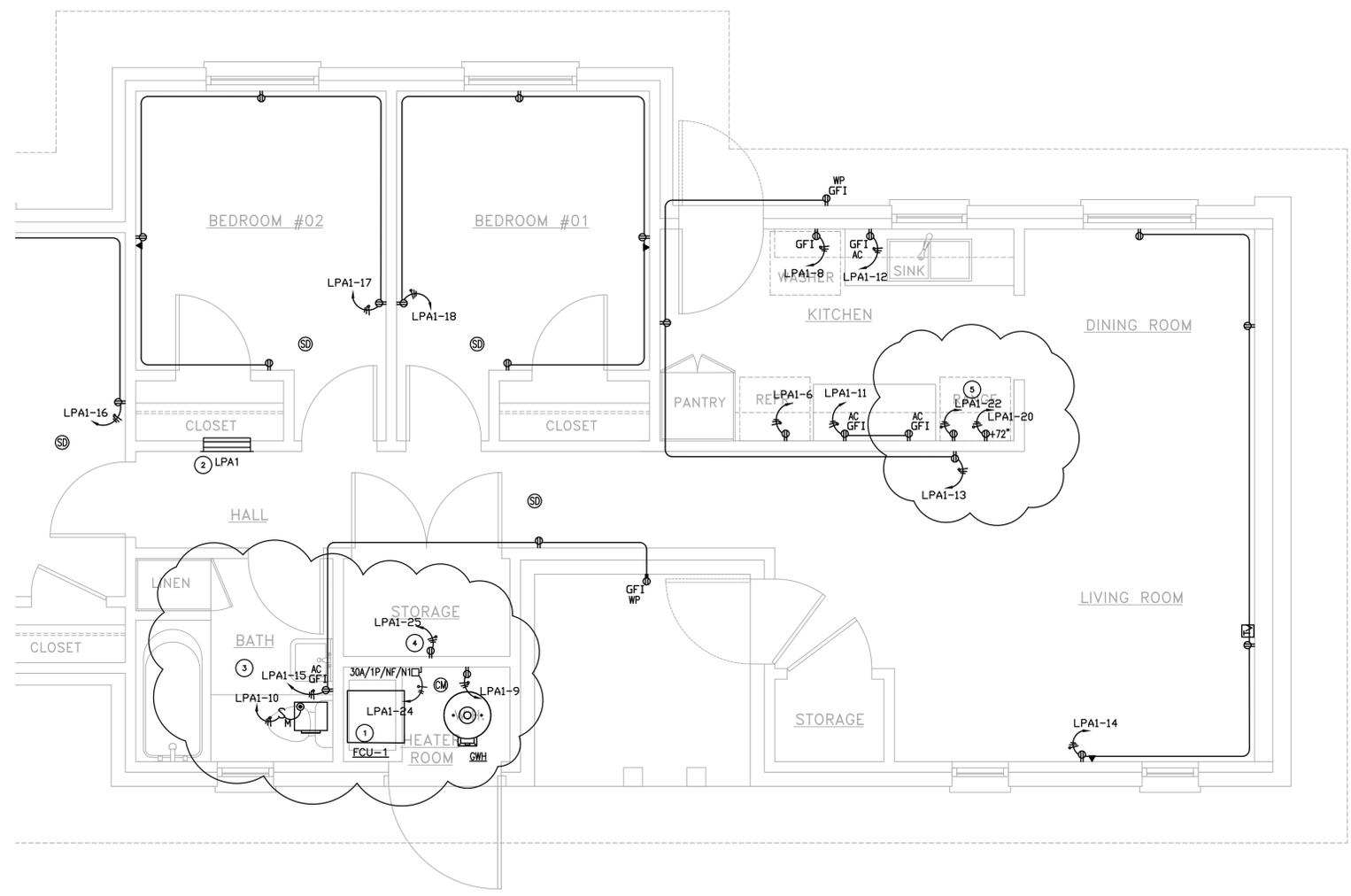

1 POWER PLAN - UNIT 942
3/8" = 1'-0"

SPRINKLE & CO.
ARCHITECTS
1110-227-7722

ALFREDO HERNANDEZ
101108
LICENSED ELECTRICAL
04-12-18

CASSIANO HOMES
PARTIAL REMODEL
2919 S LAREDO ST. SAN ANTONIO, TX 78207

ISSUE DATE: 11-28-2017

REVISIONS: 04-12-18 OWNER REVISIONS
POWER PLAN

SHEET: **E3.0**

HMB
ENGINEERING
CONSULTANTS

2902 NORTH FLORES
SAN ANTONIO, TEXAS 78212
210.393.1840 PHONE
SAN ANTONIO - RGV
TBPE FIRM REGISTRATION NO. 13361

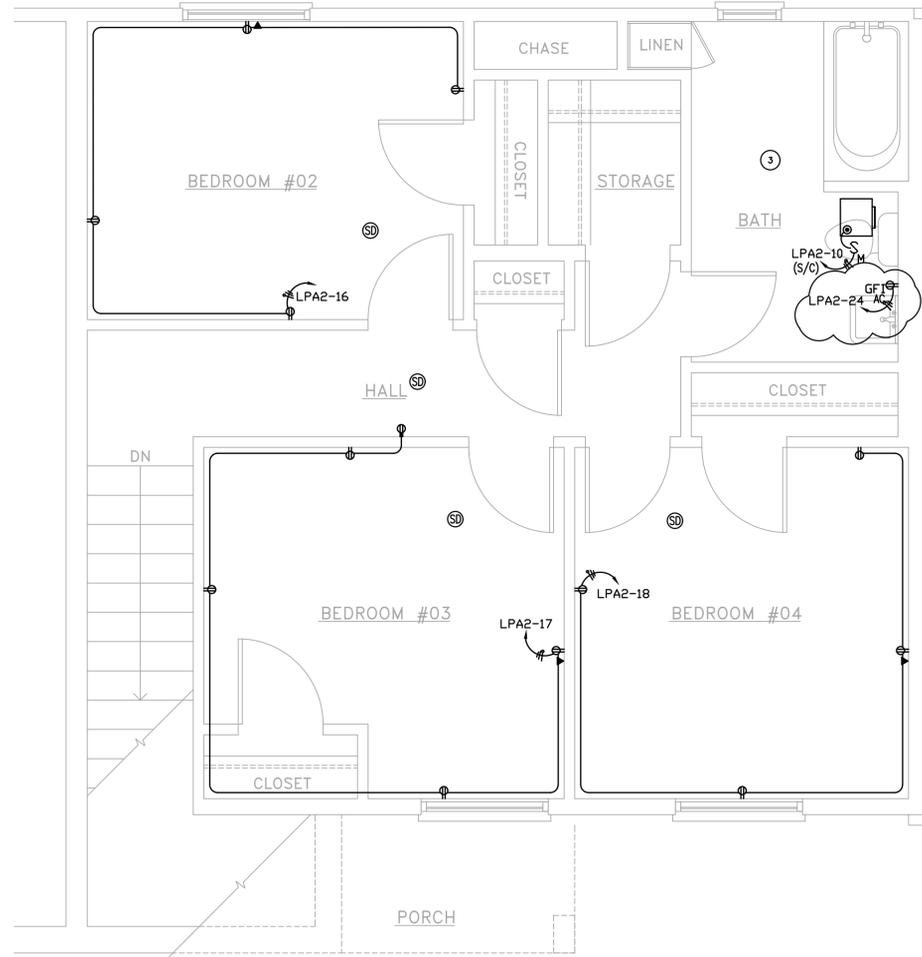
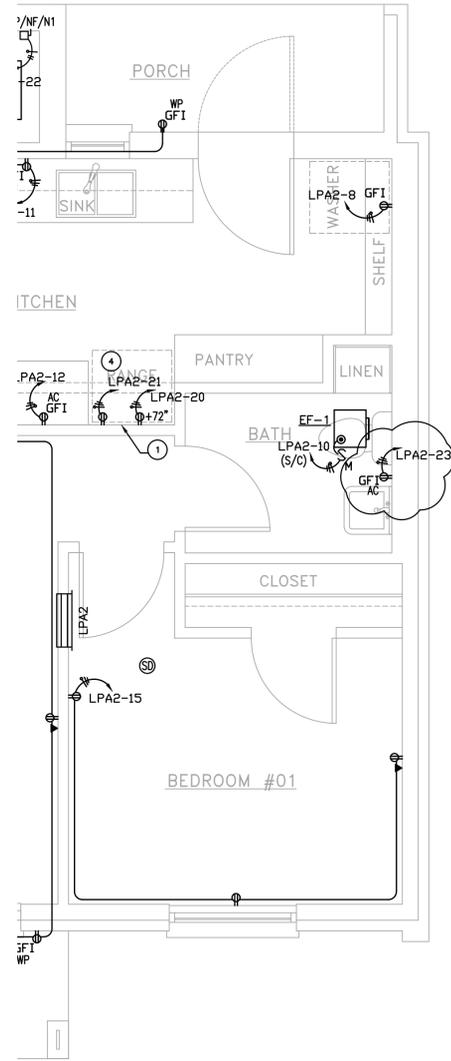

Keyed Notes:

- 1 PROVIDE NEMA 14-50R RECEPTACLE.
- 2 COORDINATE LOCATION OF CONDENSING UNIT WITH ARCHITECT/OWNER.
- 3 PROVIDE DEDICATED 20A, 120V CIRCUIT TO TENANT PANEL 20A/1P FOR POWER TO NEW CEILING MOUNTED HEATER. PROVIDE AND INSTALL A SURFACE MOUNT CEILING HEATER EQUAL TO BROAN NUTONE , 120V, 1250 WATT. PROVIDE MANUAL ROTARY TIMER MOUNTED ADJACENT TO LIGHT SWITCH FOR CONTROL OF HEATER.
- 4 PROVIDE JBOX FOR CONNECTION TO EXHAUST VENT HOOD. CONNECT TO 20A/1P SPARE IN UNIT PANEL.

.00R - UNIT 1818

2 POWER PLAN 2ND FLOOR - UNIT 1818
3/8" = 1'-0"

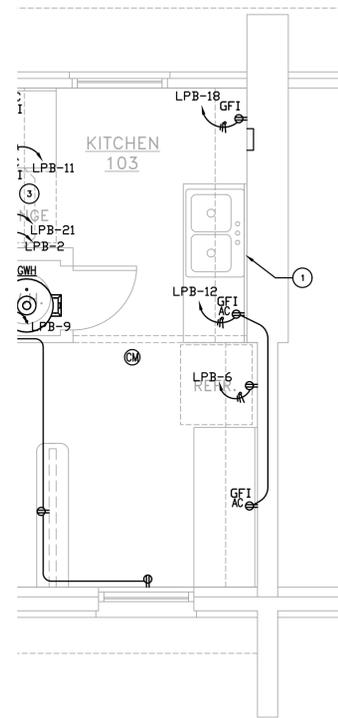

.OOR - UNIT 103 & 2404

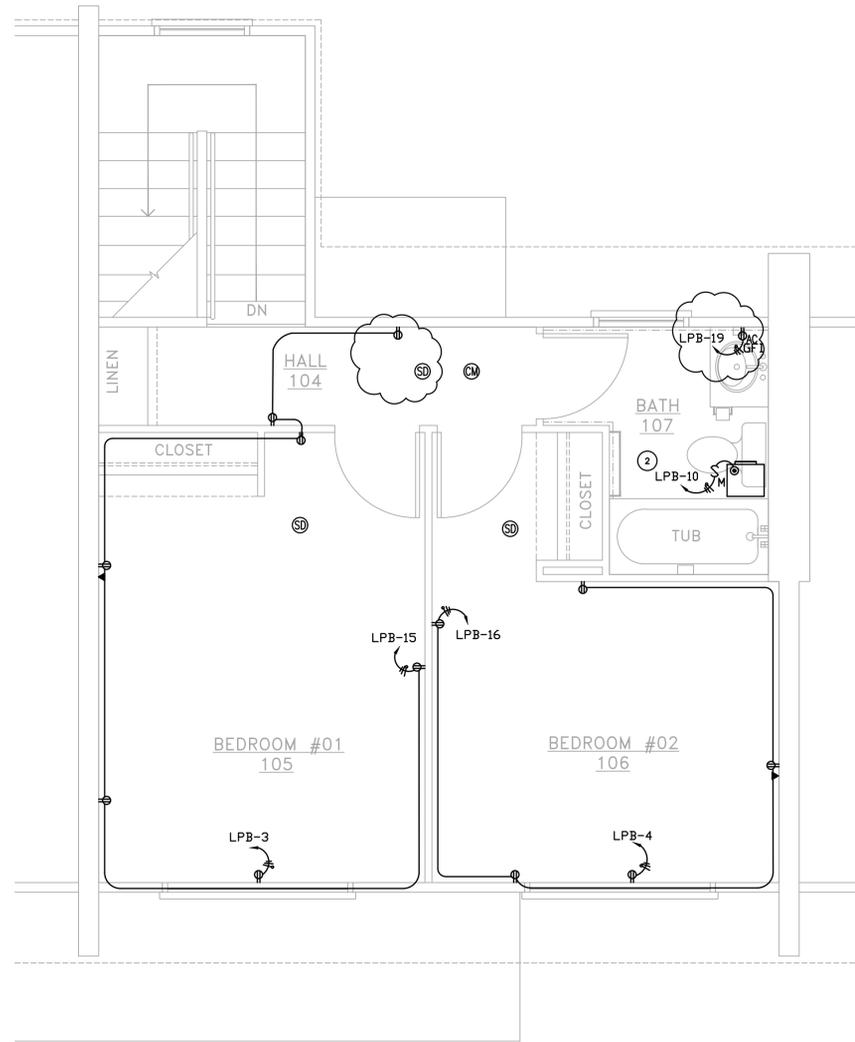

2 POWER PLAN 2ND FLOOR - UNIT 103 & 2404
3/8" = 1'-0"

Keyed Notes:

- ① PROVIDE NEMA 14-50R RECEPTACLE.
- ② PROVIDE DEDICATED 20A, 120V CIRCUIT TO TENANT PANEL 20A/1P FOR POWER TO NEW CEILING MOUNTED HEATER. PROVIDE AND INSTALL A SURFACE MOUNT CEILING HEATER EQUAL TO BROAN NUTONE , 120V, 1250 WATT. PROVIDE MANUAL ROTARY TIMER MOUNTED ADJACENT TO LIGHT SWITCH FOR CONTROL OF HEATER.
- ③ PROVIDE JBOX FOR CONNECTION TO EXHAUST VENT HOOD. CONNECT TO 20A/1P SPARE IN UNIT PANEL.

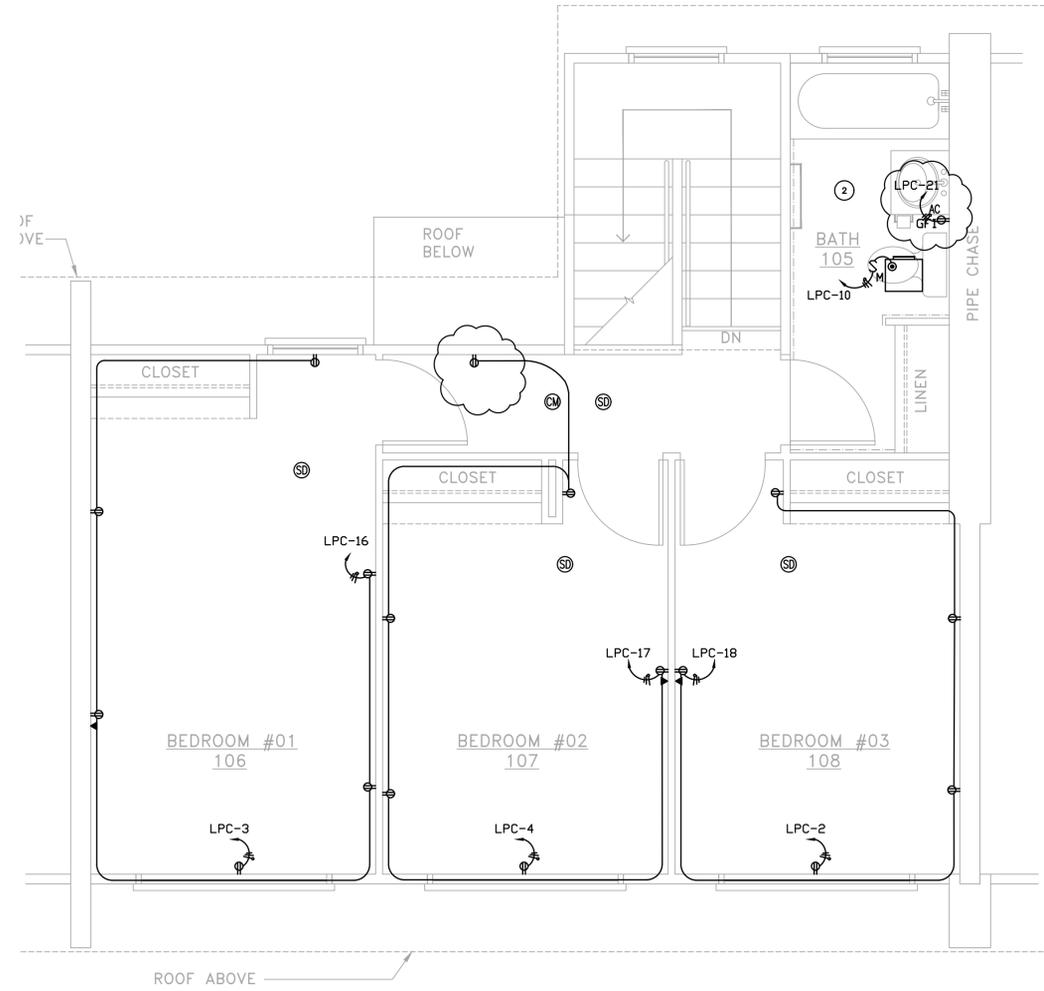
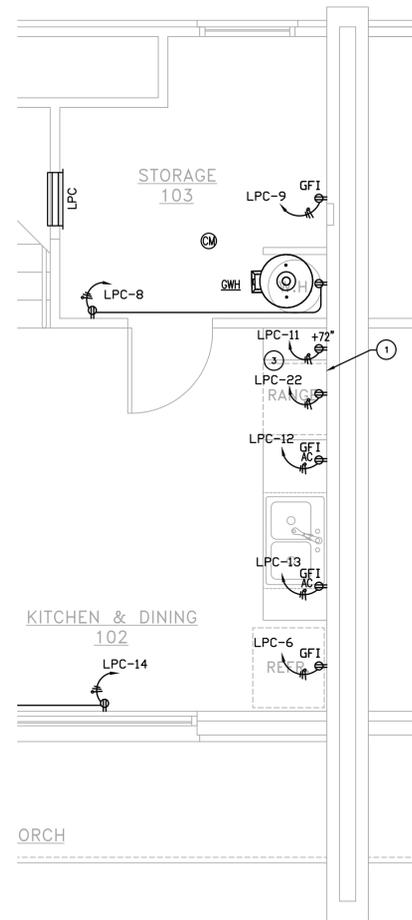

Keyed Notes:

- ① PROVIDE NEMA 14-50R RECEPTACLE.
- ② PROVIDE DEDICATED 20A, 120V CIRCUIT TO TENANT PANEL 20A/1P FOR POWER TO NEW CEILING MOUNTED HEATER. PROVIDE AND INSTALL A SURFACE MOUNT CEILING HEATER EQUAL TO BROAN NUTONE , 120V, 1250 WATT. PROVIDE MANUAL ROTARY TIMER MOUNTED ADJACENT TO LIGHT SWITCH FOR CONTROL OF HEATER.
- ③ PROVIDE JBOX FOR CONNECTION TO EXHAUST VENT HOOD. CONNECT TO 20A/1P SPARE IN UNIT PANEL.

POOR - UNIT 1523 & 3023

2 POWER PLAN 2ND FLOOR - UNIT 1523 & 3023
3/8" = 1'-0"

HM3
ENGINEERING
CONSULTANTS

2902 NORTH FLORES
SAN ANTONIO, TEXAS 78212
210.393.1840 PHONE
SAN ANTONIO - RGV
TBPE FIRM REGISTRATION NO. 13361

SPRINKLE & CO.
ARCHITECTS
11025-257-7722
www.sprinkleco.com



07-25-18

CASSIANO HOMES
PARTIAL REMODEL
2919 S LAREDO ST. SAN ANTONIO, TX 78207

ISSUE DATE:
11-28-2017

REVISIONS:
04-12-18 OWNER REVISIONS
07-25-18 COSA COMMENTS
POWER PLAN

SHEET:
E3.3

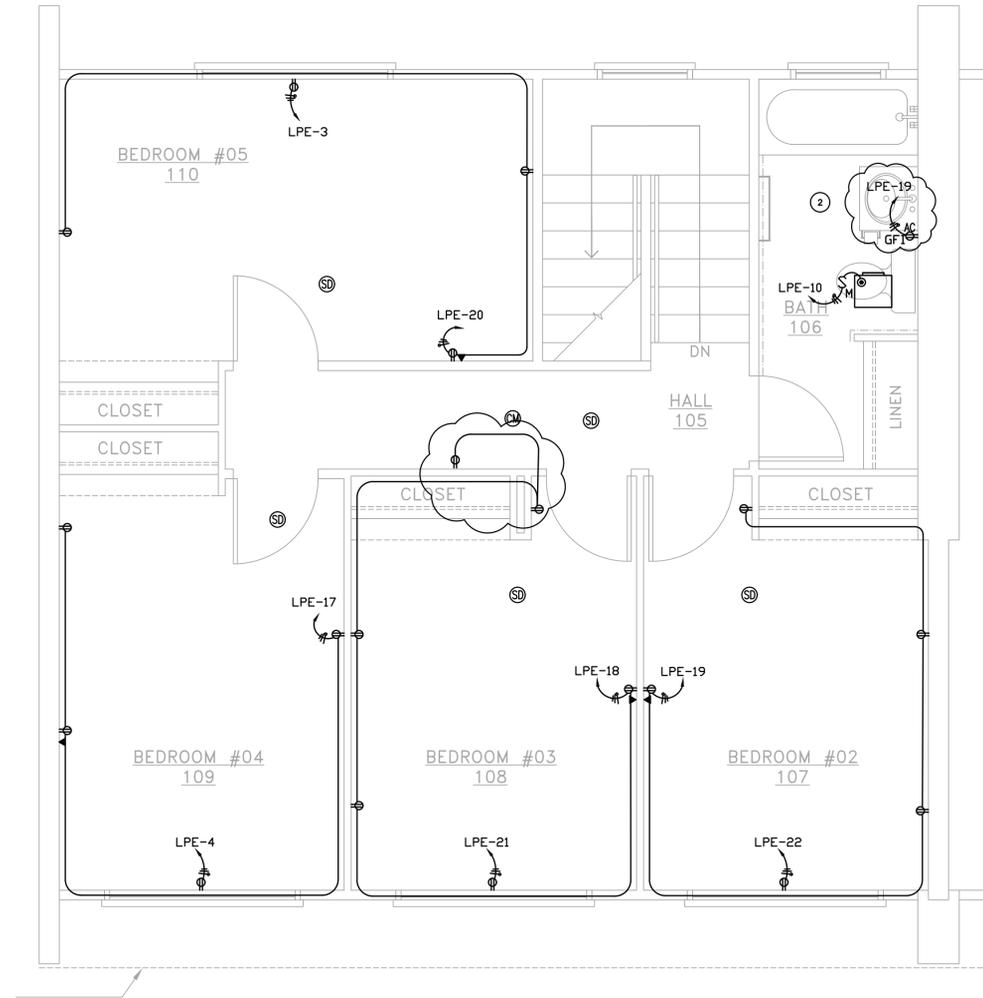
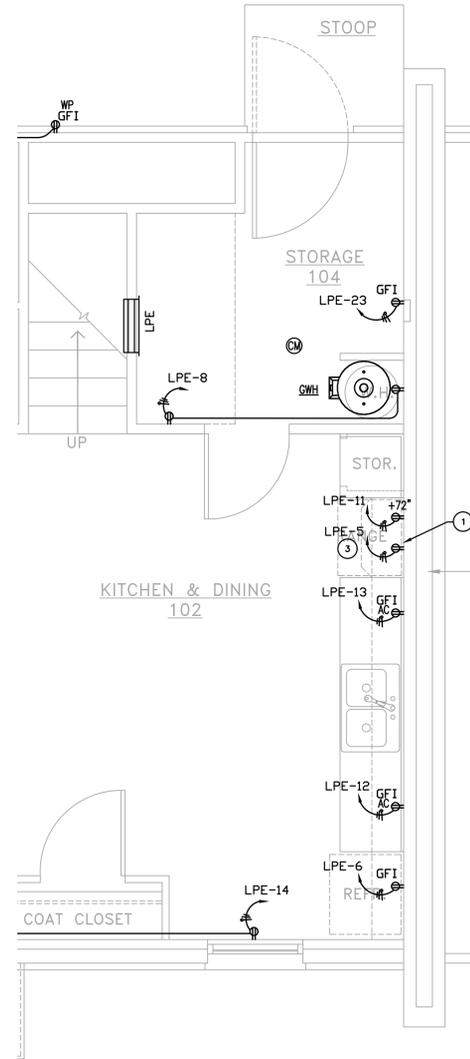

- Keyed Notes:**
- ① PROVIDE NEMA 14-50R RECEPTACLE.
 - ② PROVIDE DEDICATED 20A, 120V CIRCUIT TO TENANT PANEL 20A/1P FOR POWER TO NEW CEILING MOUNTED HEATER. PROVIDE AND INSTALL A SURFACE MOUNT CEILING HEATER EQUAL TO BROAN NUTONE, 120V, 1250 WATT. PROVIDE MANUAL ROTARY TIMER MOUNTED ADJACENT TO LIGHT SWITCH FOR CONTROL OF HEATER.
 - ③ PROVIDE JBOX FOR CONNECTION TO EXHAUST VENT HOOD. CONNECT TO 20A/1P SPARE IN UNIT PANEL.

.00R - UNIT 1501

② POWER PLAN 2ND FLOOR - UNIT 1501
3/8" = 1'-0"

HM3
ENGINEERING
CONSULTANTS

2902 NORTH FLORES
SAN ANTONIO, TEXAS 78212
210.393.1840 PHONE
SAN ANTONIO - RGV
TBPE FIRM REGISTRATION NO. 13361

SPRINKLE & CO.
ARCHITECTS
1102-227-7722
www.sprinkleco.com



07-25-18

CASSIANO HOMES
PARTIAL REMODEL
2919 S LAREDO ST. SAN ANTONIO, TX 78207

ISSUE DATE:
11-28-2017

REVISIONS:
04-12-18 OWNER REVISIONS
07-25-18 COSA COMMENTS
POWER PLAN

SHEET:
E3.4

LPA1						
ENCLOSURE TYPE:		NEMA 1				
MOUNTING:		RECESSED				
AIC RATING:		10000				
NOTES:		-----				
CIRCUIT NO.	PHASE LOADS (VA)		POLE	TRIP AMPS	DESCRIPTION	CKT NO.
	A	B				
0			1	20	SPARE	2
0	0	0	1	20	SPARE	4
500			1	20	REFRIGERATOR	6
0	0	500	1	20	WASHER	8
48			1	20	EF-1	10
360	180		1	20	RECEPTACLES	12
720			1	20	RECEPTACLES	14
540	720		1	20	RECEPTACLES	16
720			1	20	RECEPTACLES	18
325	300		1	20	RANGE HOOD	20
300			1	20	GAS RANGE	22
0	0	1650	1	20	FURNACE	24
0			1	20	SPACE	26
0	0	0	1	20	SPACE	28
0			1	20	SPACE	30
LOAD PHASE TOTALS (VA)						
4575						
DEMAND FACTOR	DEMAND LOAD (KVA)	DEMAND LOAD	8.6 KVA			
1.00	1.6	SPARE CAPACITY	27.4 KVA			
1.25	0.4	SPARE CAPACITY	114.0 AMPS			
1.25	0.0	SPARE CAPACITY	76 %			
1.00	0.3					
1.25	0.4					
1.00	4.9					
1.00	1.0					
	8.6					
	36.0					

PANEL LPA2											
ENCLOSURE TYPE:		NEMA 1									
MOUNTING:		RECESSED									
AIC RATING:		10000									
NOTES:		-----									
CIRCUIT NO.	DESCRIPTION	TRIP AMPS	POLE	PHASE LOADS (VA)				POLE	TRIP AMPS	DESCRIPTION	CKT NO.
				A	B	C	D				
1	SPARE	20	1	0	0			1	20	SPARE	2
3	SPARE	20	1					1	20	SPARE	4
5	SPARE	20	1	0	500			1	20	REFRIGERATOR	6
7	SPARE	20	1			0	500	1	20	WASHER	8
9	GWH	20	1	180	96			1	20	EF-1 (2)	10
11	RECEPTACLES	20	1			360	180	1	20	RECEPTACLES	12
13	RECEPTACLES	20	1	540	900			1	20	RECEPTACLES	14
15	RECEPTACLES	20	1			720	720	1	20	RECEPTACLES	16
17	RECEPTACLES	20	1	900	900			1	20	RECEPTACLES	18
19	LIGHTING	20	1			428	300	1	20	RANGE HOOD	20
21	GAS RANGE	20	1	300	1650			1	20	FURNACE	22
23	SPARE	20	1			0	0	1	20	SPACE	24
25	SPARE	20	1	0	0			1	20	SPACE	26
27	SPARE	20	1			0	0	1	20	SPACE	28
29	SPACE	20	1	0	0			1	20	SPACE	30
CONNECTED LOAD PHASE TOTALS (VA)											
5966				3208							
CONNECTED LOAD (KVA)	DEMAND FACTOR	DEMAND LOAD (KVA)	DEMAND LOAD	9.4 KVA							
1.6	1.00	1.6	SPARE CAPACITY	26.6 KVA							
0.4	1.25	0.5	SPARE CAPACITY	111.0 AMPS							
0.0	1.25	0.0	SPARE CAPACITY	74 %							
0.4	1.00	0.4									
0.3	1.25	0.4									
5.4	1.00	5.4									
1.0	1.00	1.0									
TOTAL:	9.2	9.4									
LOAD (AMPS):	38.2	39.0									

LPB						
ENCLOSURE TYPE:		NEMA 1				
MOUNTING:		RECESSED				
AIC RATING:		10000				
NOTES:		-----				
CIRCUIT NO.	PHASE LOADS (VA)		POLE	TRIP AMPS	DESCRIPTION	CKT NO.
	A	B				
300			1	20	RANGE HOOD	2
780	780		1	20	WINDOW A/C UNIT	4
500			1	20	REFRIGERATOR	6
0	0	180	1	20	RECEPTACLE	8
48			1	20	EF-1	10
360	360		1	20	RECEPTACLES	12
720			1	20	RECEPTACLES	14
900	900		1	20	RECEPTACLES	16
500			1	20	WASHER	18
180	180		1	20	SPACE HEATER	20
0			1	20	SPACE	22
0	0	0	1	20	SPACE	24
0			1	20	SPACE	26
0	0	0	1	20	SPACE	28
0			1	20	SPACE	30
LOAD PHASE TOTALS (VA)						
4620						
DEMAND FACTOR	DEMAND LOAD (KVA)	DEMAND LOAD	8.9 KVA			
1.00	2.3	SPARE CAPACITY	15.1 KVA			
1.25	0.3	SPARE CAPACITY	63.1 AMPS			
1.25	0.0	SPARE CAPACITY	63 %			
1.00	0.3					
1.25	0.4					
1.00	4.5					
1.00	1.0					
	8.9					
	36.9					

PANEL LPC											
ENCLOSURE TYPE:		NEMA 1									
MOUNTING:		RECESSED									
AIC RATING:		10000									
NOTES:		-----									
CIRCUIT NO.	DESCRIPTION	TRIP AMPS	POLE	PHASE LOADS (VA)				POLE	TRIP AMPS	DESCRIPTION	CKT NO.
				A	B	C	D				
1	WINDOW A/C UNIT	20	1	780	780			1	20	WINDOW A/C UNIT	2
3	WINDOW A/C UNIT	20	1			780	780	1	20	WINDOW A/C UNIT	4
5	SPARE	20	1	0	500			1	20	REFRIGERATOR	6
7	SPARE	20	1			0	360	1	20	GWH	8
9	WASHER	20	1	500	48			1	20	EF-1	10
11	RANGE HOOD	20	1			300	180	1	20	RECEPTACLES	12
13	RECEPTACLES	20	1	180	360			1	20	RECEPTACLES	14
15	RECEPTACLES	20	1			720	900	1	20	RECEPTACLES	16
17	RECEPTACLES	20	1	720	900			1	20	RECEPTACLES	18
19	LIGHTING	20	1			351	180	1	20	SPACE HEATER	20
21	SPACE HEATER	20	1	180	300			1	20	GAS RANGE	22
23	SPARE	20	1			0	0	1	20	SPACE	24
25	SPARE	20	1	0	0			1	20	SPACE	26
27	SPACE	20	1			0	0	1	20	SPACE	28
29	SPACE	20	1	0	0			1	20	SPACE	30
CONNECTED LOAD PHASE TOTALS (VA)											
5248				4551							
CONNECTED LOAD (KVA)	DEMAND FACTOR	DEMAND LOAD (KVA)	DEMAND LOAD	10.0 KVA							
3.1	1.00	3.1	SPARE CAPACITY	14.0 KVA							
0.3	1.25	0.4	SPARE CAPACITY	58.5 AMPS							
0.0	1.25	0.0	SPARE CAPACITY	58 %							
0.3	1.00	0.3									
0.3	1.25	0.4									
4.7	1.00	4.7									
1.0	1.00	1.0									
TOTAL:	9.8	10.0									
LOAD (AMPS):	40.8	41.5									

HMB
ENGINEERING
CONSULTANTS

2902 NORTH FLORES
SAN ANTONIO, TEXAS 78212
210.393.1840 PHONE

SAN ANTONIO - RGV
TBPE FIRM REGISTRATION NO. 13361

SPRINKLE & CO.
ARCHITECTS
ALFREDO HERNANDEZ
101108
LICENSED PROFESSIONAL ARCHITECT
04-12-18



04-12-18

CASSIANO HOMES
PARTIAL REMODEL
SAN ANTONIO, TX 78207
2919 S LAREDO ST.

ISSUE DATE: 11-28-2017

REVISIONS: 04-12-18 OWNER REVISIONS
ELECTRICAL SCHEDULES

SHEET: E4.0

LPE				
ENCLOSURE TYPE:		NEMA 1		
MOUNTING:		RECESSED		
AIC RATING:		10000		
NOTES: -----				
LOADS (VA)	POLE	TRIP AMPS	DESCRIPTION	CKT NO
B	1	20	WINDOW A/C UNIT	2
780	780	1	WINDOW A/C UNIT	4
		1	REFRIGERATOR	6
0	360	1	GWH	8
		1	EF-1	10
300	180	1	RECEPTACLES	12
		1	RECEPTACLES	14
900	720	1	RECEPTACLES	16
		1	RECEPTACLES	18
900	540	1	RECEPTACLES	20
		1	WINDOW A/C UNIT	22
500	180	1	SPACE HEATER	24
		1	SPARE	26
0	0	1	SPARE	28
		1	SPARE	30
PHASE TOTALS (VA)				
6140				
DEMAND FACTOR	DEMAND LOAD (KVA)	DEMAND LOAD	12.7 KVA	
.00	5.8	SPARE CAPACITY	17.3 KVA	
.00	4.7	SPARE CAPACITY	72.0 AMPS	
.25	0.5	SPARE CAPACITY	58 %	
.25	0.0			
.00	0.3			
.25	0.4			
.00	1.0			
	12.7			
	53.0			

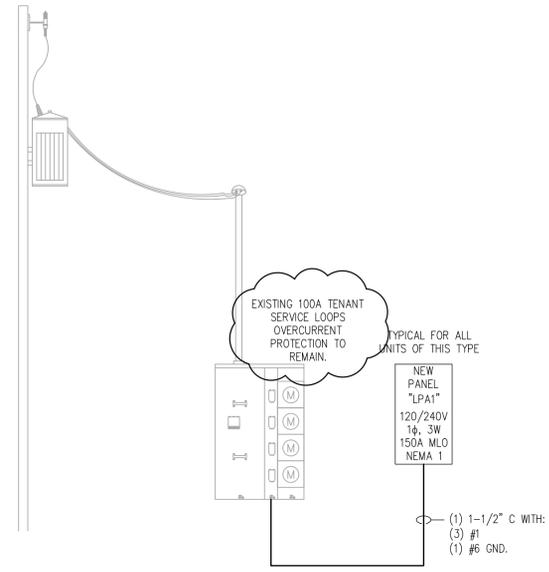

1 ELECTRICAL RISER - UNIT 942
N.T.S.

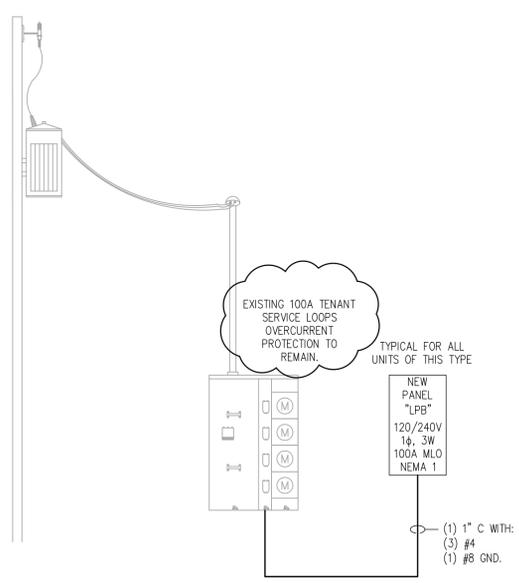

3 ELECTRICAL RISER - UNIT 103 & 2404
N.T.S.

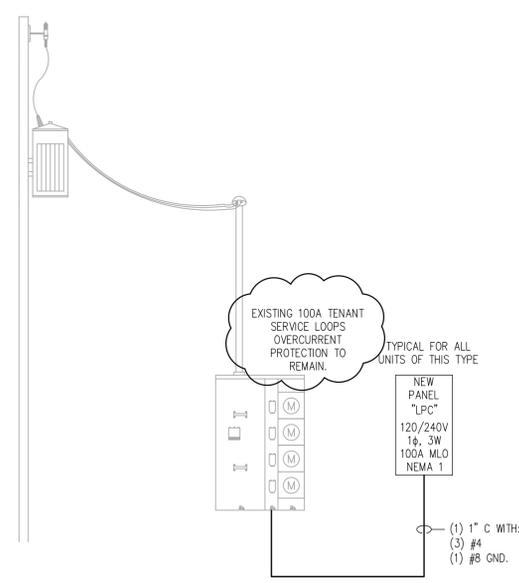

4 ELECTRICAL RISER - UNIT 1523 & 3023
N.T.S.

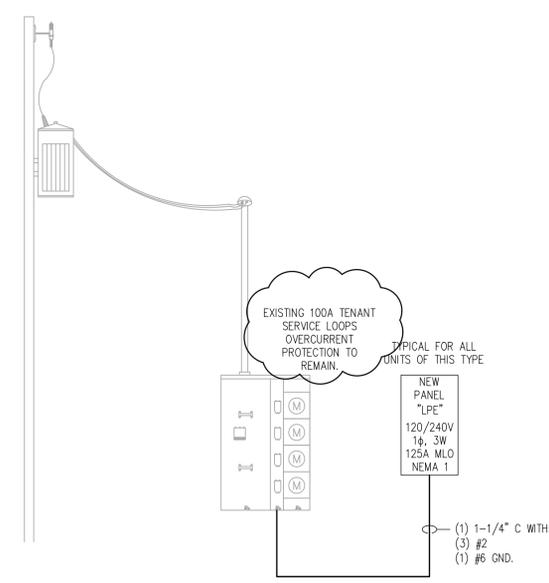

5 ELECTRICAL RISER - UNIT 1501
N.T.S.

HM3
ENGINEERING
CONSULTANTS

2902 NORTH FLORES
SAN ANTONIO, TEXAS 78212
210.393.1840 PHONE
SAN ANTONIO - RGV
TBPE FIRM REGISTRATION NO. 13361

SPRINKLE & CO.
ARCHITECTS
1112-227-7722
1112-227-7722



07-25-18

CASSIANO HOMES
PARTIAL REMODEL
SAN ANTONIO, TX 78207
2919 S LAREDO ST.

ISSUE DATE: 11-28-2017
REVISIONS:
04-12-18 OWNER REVISIONS
07-2-18 ELECTRICAL
SCHEDULES AND
RISER
SHEET: E5.0

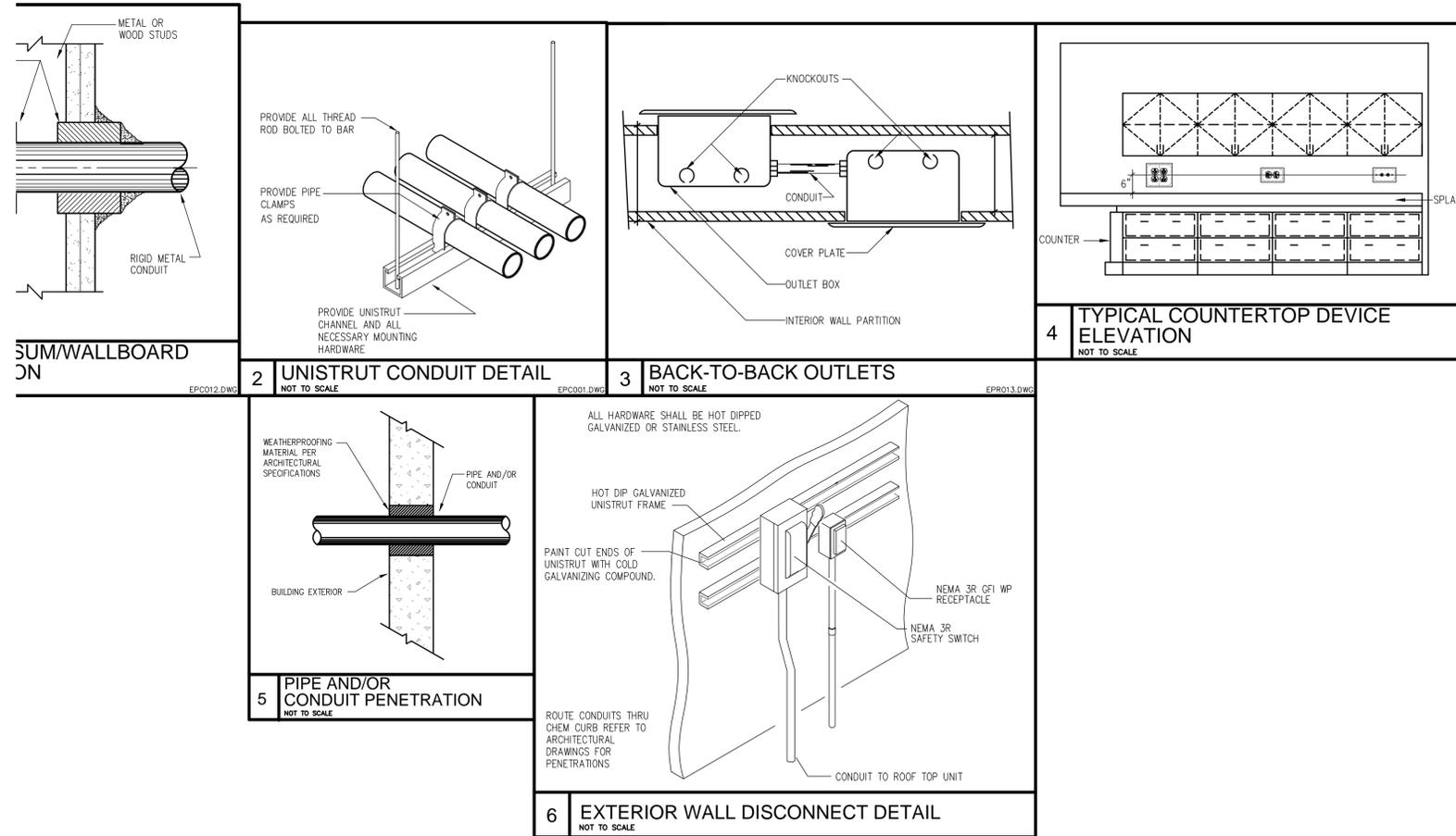

ABBREVIATIONS

A	
ABV	ABOVE
AC	ALTERNATING CURRENT / ABOVE CEILING
ACMPR	AIR COMPRESSOR
ACU	AIR CONDITIONING UNIT
AFF	ABOVE FINISHED FLOOR
AFMS	AIR FLOW MEASURING STATION
AHU	AIR HANDLING UNIT
AMB	AMBIENT
AMP	AMPERE
ANSI	"AMERICAN NATIONAL STANDARDS INSTITUTE"
APPROX.	APPROXIMATE
ARI	AMERICAN REFRIGERATION INSTITUTE
ASHRAE	"AMERICAN SOCIETY OF HEATING, REFRIGERATION, and AIR CONDITIONING ENGINEERS"
ASME	"AMERICAN SOCIETY OF MECHANICAL ENGINEERS"
ASPE	"AMERICAN SOCIETY OF PLUMBING ENGINEERS"
ASTM	"AMERICAN SOCIETY FOR TESTING AND MATERIALS"
AVG	AVERAGE
AWWA	"AMERICAN WATER WORKS ASSOCIATION"
B	
B	BOILER
BARO	BAROMETRIC
BAROPR	BAROMETRIC PRESSURE
BF	BELOW FLOOR
BFC	BELOW FINISHED CEILING
BG	BELOW GRADE
BHP	BRAKE HORSEPOWER
BOD	BOTTOM OF DUCT
BOM	BILL OF MATERIAL
BOP	BOTTOM OF PIPE
BTU	BRITISH THERMAL UNIT
C	
CCL	COOLING COIL
CCW	COUNTERCLOCKWISE
CD	CONDENSATE DRAIN
CFH	CUBIC FEET PER HOUR
CFM	CUBIC FEET PER MINUTE
CH	CHILLER
CHP	CHILLER WATER PUMP
CHR	CHILLED WATER RETURN
CHS	CHILLED WATER SUPPLY
CLR	CLOSED CIRCUIT COOLER
CMPR	COMPRESSOR
CR	CONDENSATE RETURN
CRU	COMPUTER ROOM UNIT
CT	COOLING TOWER
CU	CONDENSING UNIT
CU.FT.	CUBIC FEET
CU.IN.	CUBIC INCH
CV	CONSTANT VOLUME
CO2	CARBON DIOXIDE SENSOR
CWP	CONDENSER WATER PUMP
CWR	CONDENSER WATER RETURN
CWS	CONDENSER WATER SUPPLY
D	
dB	DECIBEL
D	DRAIN
DBT	DRY BULB TEMPERATURE
DC	DIRECT CURRENT
DDC	DIRECT DIGITAL CONTROL
DEG	DEGREE
DENS	DENSITY
DIA	DIAMETER
DIFF	DIFFERENCE or DELTA
DN	DOWN
DP	DEW POINT
DPT	DEW POINT TEMPERATURE
E	
E/A	EXHAUST AIR
EA	EACH
EAT	ENTERING AIR TEMPERATURE
EDH	ELECTRIC DUCT HEATER
EF	EXHAUST FAN
EFF	EFFICIENCY
ENTH.	ENTHALPY
EOD	EMERGENCY OVERFLOW DRAIN
ET	EXPANSION TANK
EVP	EVAPORATIVE COOLER
EW	ENTERING WATER TEMPERATURE
EXP	EXPANSION
F	
F	FAHRENHEIT
FCU	FAN COIL UNIT
FUR.	FLOOR
FOB	FLAT ON BOTTOM
FOT	FLAT ON TOP
FPM	FEET PER MINUTE
FPS	FEET PER SECOND
FRTU	FAN POWERED TERMINAL UNIT
FRN	FURWACE
FT	FEET
FT.W.G.	FEET of WATER GAGE
FVEL	FACE VELOCITY
G	
GAL.	GALLONS
GPH	GALLONS PER HOUR
GPM	GALLONS PER MINUTE
GR	GRAINS
H	
HCL	HEATING COIL
HD	HOOD
HGT	HEIGHT
HP	HORSEPOWER
HPS	HIGH PRESSURE STEAM
HR	HOUR
HUM	HUMIDIFIER
HWP	HOT WATER PUMP
HWR	HOT WATER RETURN
HWS	HOT WATER SUPPLY
HZ	HERTZ
I	
ID	INSIDE DIAMETER
IH	INTAKE HOOD
INCH	INCH
IN.W.G.	INCHES of WATER GAGE
IRH	INFRARED HEATER
J	

ABBREVIATIONS

K	
KHE	KITCHEN HOOD EXHAUST
kw	KILOWATTS
kwh	KILOWATT HOUR
L	
L-#	LOUVER DESIGNATION
LAT	LEAVING AIR TEMPERATURE
LBS.	POUNDS
LIQ	LIQUID
LPS	LOW PRESSURE STEAM
LWT	LEAVING WATER TEMPERATURE
M	
MA	MAKEUP AIR
MAX.	MAXIMUM
MBH	THOUSAND BTU/HR.
MCA	MINIMUM CIRCUIT AMPACITY
MCF	THOUSAND CUBIC FEET
MIN.	MINIMUM or MINUTES
MOC	MAXIMUM OVERCURRENT PROTECTION
MOC	MEDIUM PRESSURE STEAM
MPS	"MANUFACTURERS STANDARDIZATION SOCIETY of the Valves and Fittings Industry, Inc."
MSS	
N	
N/A	NOT APPLICABLE
NC	NOISE CRITERIA
N.C.	NORMALLY CLOSED
NEBB	NATIONAL ENVIRONMENTAL BALANCING BUREAU
N.I.C.	NOT IN CONTRACT
N.O.	NORMALLY OPEN
N.T.S.	NOT TO SCALE
O	
O/A	OUTSIDE AIR
OD	OUTSIDE DIAMETER
OSHA	OCCUPATIONAL SAFETY and HEALTH ADMINISTRATION
OZ	OUNCE
P	
PD	PRESSURE DIFFERENCE
PH	PHASE
PPM	PART PER MILLION
PRI	PRIMARY
PRESS.	PRESSURE
PSI	POUNDS PER SQUARE INCH
PSIA	"PSI, ABSOLUTE"
PSIG	"PSI, GAGE"
Q	
R	
R	THERMAL RESISTANCE
R-22	REFRIGERANT--22
R/A	RETURN AIR
RCVR	RECEIVER
RD	ROOF DRAIN
RE	"REFER TO DETAIL NO.1, SHEET M--xx"
RE/M--xx	RECUR.
RE/CIRC.	RETURN FAN
RF	RELIEF HOOD
RH	REFRIGERANT LIQUID
RL	REVOLUTIONS PER MINUTE
RPM	REVOLUTIONS PER SECOND
RPS	REFRIGERANT SUCTION
RS	ROOFTOP UNIT
RTU	RELIEF VENT
RV	
S	
s	SECOND
SA	SOUND ATTENUATOR
S/A	SUPPLY AIR
SAT	SATURATION
SD	SMOKE DETECTOR
SF	SUPPLY FAN
SG	SPECIFIC GRAVITY
SH-#	SPACE HEATER DESIGNATION
SMACNA	"SHEET METAL and AIR CONDITIONING" CONTRACTORS' NATIONAL ASSOCIATION"
SP	STATIC PRESSURE
SPEC.	SPECIFICATION
SQ.FT.	SQUARE FEET
SUCT.	SUCTION
T	
TD	TEMPERATURE DIFFERENCE
TEMP	TEMPERATURE
TONS	TONS OF REFRIGERATION
TSTAT	THERMOSTAT
TU	TERMINAL UNIT
U	
U	HEAT TRANSFER COEFFICIENT
U/C	UNDER COUNTER
UG	UNDERGROUND
UH	UNIT HEATER
U.N.O.	UNLESS NOTED OTHERWISE
UV	UNIT VENTILATOR
V	
V	VOLTS
VA	VOLT AMPERE
VAC	VACUUM
VAR	VARIABLE
VAV	VARIABLE AIR VOLUME
VEL.	VELOCITY
VENT.	VENTILATION
VERT.	VERTICAL
VFD	VARIABLE FREQUENCY DRIVE
VOL.	VOLUME
VP	VELOCITY PRESSURE
VTR	VENT THRU ROOF
W	
W/	WITH
W/O	WITHOUT
W	WATTS
WB	WET BULB
WBT	WET BULB TEMPERATURE
WT	WEIGHT
X	
Y	
YCO	YARD CLEANOUT
YD	YARD
YR	YEAR
Z	
ZN	ZONE

GENERAL MECHANICAL NOTES AND SPECIFICATIONS:

GENERAL

- COORDINATE WORK AMONG ALL DISCIPLINES. IT IS NOT THE INTENT OF THESE DOCUMENTS TO DICTATE WHO MUST DO THE WORK. ALL WORK SHOWN IS THE RESPONSIBILITY OF THE (PRIME) CONTRACTOR.
- FIELD VERIFY ALL CONDITIONS AND MEASURE DIMENSIONS WITHIN THE BUILDING PRIOR TO ORDERING EQUIPMENT AND/OR PROCEEDING WITH INSTALLATION.
- ALL EQUIPMENT SHALL BE FACTORY TESTED, AND CONTRACTOR SHALL VERIFY THEIR CONDITION PRIOR TO INSTALLATION. CONTRACTOR IS RESPONSIBLE FOR EQUIPMENT DAMAGED DURING MOVING AND INSTALLATION.
- EQUIPMENT FOUND DEFECTIVE PRIOR TO FINAL ACCEPTANCE SHALL BE REPLACED AT NO COST TO OWNER.
- SUBMISSION OF BID PROPOSAL IS CONSIDERED AN ACKNOWLEDGEMENT THAT CONTRACTOR VISITED SITE, AND VERIFIED ALL EXISTING CONDITIONS, AND INCLUDED ANY MODIFICATIONS TO EXISTING AND NEW WORK REQUIRED FOR INSTALLATION OF A COMPLETE AND OPERATIONAL MECHANICAL SYSTEM.
- COORDINATE WITH OWNER AND ENGINEER FOR ANY DISRUPTION IN UTILITY SERVICES, PARTICULARLY THOSE THAT MIGHT AFFECT OTHER BUILDINGS IN THE CAMPUS.
- CONTRACTOR SHALL NOT PROCEED WITH ANY WORK INVOLVING A CHANGE IN PROJECT SCOPE OR COST WITHOUT FIRST HAVING OBTAINED ENGINEER'S APPROVAL IN WRITING. UNLESS ENGINEER HAS AGREED TO SUCH CHANGE PRIOR TO IT BEING DONE, AND HAS AGREED THAT AN INCREASE IN COST ASSOCIATED WITH SUCH CHANGE IS WARRANTED; CONTRACTOR WILL NOT BE REIMBURSED FOR SUCH CHANGE.
- TESTING, ADJUSTING AND BALANCING (TAB) CONTRACTOR SHALL BE RETAINED BY THE PRIME CONTRACTOR TAB SHALL NOT BE A PART OF THE MECHANICAL CONTRACT.

CODES AND ORDINANCES

- PERFORM ALL WORK PER LATEST VERSION OF INTERNATIONAL MECHANICAL CODE, AND APPLICABLE LOCAL CODES AND ORDINANCES, UNLESS DRAWINGS OR SPECIFICATIONS HAVE MORE STRINGENT REQUIREMENTS.
- CONTRACTOR IS RESPONSIBLE FOR ALL PERMITS AND FEES ASSOCIATED WITH PROJECT, INCLUDING FEES FOR INSPECTIONS, APPLICATIONS, AND PROVISION OF NEW SERVICES.
- NOTIFY ENGINEER OF ANY ASPECTS OF DESIGN WHICH ARE THOUGHT TO BE IN NONCOMPLIANCE WITH APPLICABLE CODES.

COORDINATION

- REFER TO ARCHITECTURAL AND STRUCTURAL PLANS FOR DETAILS OF CONSTRUCTION, INCLUDING BEAMS, FLOOR AND WALL PENETRATIONS, CHASES, AND REFLECTED CEILING PLANS. VERIFY OPENING SIZES WITH EQUIPMENT FURNISHED.
- COORDINATE ALL WORK WITH OTHER TRADES; COORDINATE SCHEDULE OF WORK WITH ALL SUB-CONTRACTORS TO ACHIEVE SMOOTH FLOW OF CONSTRUCTION.
- CONTRACTOR SHALL REVIEW COMPLETE DOCUMENTS PRIOR TO SUBMITTAL OF PROPOSAL TO GAIN COMPLETE UNDERSTANDING OF PROJECT SCOPE, WORK BY OTHERS, AND MECHANICAL WORK ASSOCIATED WITH OTHER DISCIPLINES.
- ENGINEER/ ARCHITECT MUST BE GIVEN AT LEAST A TEN (10) WORKING DAY NOTICE TO PERFORM ALL TYPES OF INSPECTIONS. COORDINATE WORK SCHEDULE WITH ARCHITECT AND ENGINEER TO PLAN ACCORDINGLY FOR APPROPRIATE INSPECTIONS.

ECONOMIZER.

- FOR SYSTEMS THAT REQUIRE ECONOMIZER, MECHANICAL CONTRACTOR SHALL PROVIDE A CONTROLLER EQUAL TO HONEYWELL JADE ECONOMIZER MODULE W7220. REFER TO ECONOMIZER DETAIL FOR ADDITIONAL INFORMATION.

METAL AND FLEXIBLE DUCTS

- DRAWINGS ARE DIAGRAMMATIC IN NATURE. FOR CLARITY SAKE, MOST DUCT OFFSETS/RISES/DROPS ARE NOT SHOWN. RECTANGULAR AND ROUND DUCTWORK SHALL BE GALVANIZED STEEL. SIZES SHOWN ARE INSIDE CLEAR DIMENSION.
- VERIFY BOTTOM OF DUCT ELEVATION AND COORDINATE WITH OTHER TRADES.
- CONSTRUCT AND LEAKAGE TEST ALL DUCTWORK BASED ON SMACNA REQUIREMENTS. COORDINATE PRESSURE CLASSES WITH EQUIPMENT SCHEDULES.
- ALL GALVANIZED SHEET METAL DUCT WORK SHALL COMPLY WITH SMACNA'S "HVAC DUCT CONSTRUCTION STANDARDS--METAL AND FLEXIBLE".
- USE 2" GLASS FIBER--REINFORCED FABRIC JOINT AND SEAM TAPE. USE WATER BASED JOINT AND SEAM SEALER. USE FIRE RESISTANT SEALER FOR FILLING OPENINGS AROUND DUCT PENETRATIONS THROUGH WALLS. ACCEPTABLE PRODUCTS ARE DOW CORNING, FIRE STOP FOAM AND FIRE STOP SEALER OR EQUAL.
- USE SHEET METAL SCREWS OR BLIND RIVETS COMPATIBLE WITH DUCT MATERIALS WHEN SECURING ALL DUCTWORK TO STRUCTURE.
- FLEXIBLE DUCT MAY BE USED TO CONNECT TO SUPPLY DIFFUSERS. MAXIMUM LENGTH OF FLEXIBLE DUCT LIMITED TO 8 FEET. PROVIDE FLEXMASTER TYPE 8M UL 181 CLASS I AIR DUCT OR EQUAL. FLEXIBLE DUCT SHALL HAVE MIN. R-8 INSULATING VALUE.
- FLEXIBLE DUCT CLAMP SHALL BE OF STAINLESS STEEL BANDS WITH CADMIUM PLATED HEX SCREW TO TIGHTEN BAND WITH WORM GEAR ACTION.
- PROVIDE TURNING VANES IN ALL SPLITS, TEES AND SWEEP 90 DEGREE ANGLE DUCT FITTINGS. MANUFACTURED TURNING VANES TO BE 1-1/2" WIDE, DOUBLE VANE, CURVED BLADES OF GALVANIZED SHEET STEEL SET 90° O.C. ACCEPTABLE MANUFACTURERS ARE DUCTMATE INDUSTRIES, METALFARE, WARD INDUSTRIES OR EQUAL.
- WHERE RECTANGULAR TEE FITTINGS ARE SHOWN, PROVIDE FITTING WITH ADJUSTABLE DIVIDER SHEET AND TURNING VANES.
- WHERE RECTANGULAR MAIN AND BRANCH CONNECTIONS ARE SHOWN, PROVIDE EXTRACTOR VANES.
- PROVIDE MANUAL VOLUME CONTROL DAMPERS WHERE SHOWN ON DRAWINGS. DAMPERS TO HAVE NEOPRENE BLADE SEALS AND GALVANIZED STEEL FRAMES, TIE BARS, DAMPER AND BRACKETS. ACCEPTABLE MANUFACTURERS ARE RUSKIN CO., NAILOR INDUSTRIES, FLEXMASTER OR EQUAL.
- ABOVE INACCESSIBLE CEILING AND WHERE DUCT CONFIGURATION DOES NOT ALLOW FOR INSTALLATION OF DAMPER IN DUCTWORK OR DIFFUSER, PROVIDE REMOTE MANUAL DAMPER BY YOUNG REGULATOR. (BOWDEN CABLE CONTROL SYSTEM). CONTRACTOR MAY PROVIDE OPPOSED BLADE DAMPER THAT IS INTEGRAL TO GRID WITH ENGINEER'S APPROVAL.

INSULATION

- DUCT WRAP INSULATION SHALL BE MINERAL FIBER INSULATION. ALL SERVICE JACKETING MANUFACTURED FROM KRAFT PAPER, REINFORCING SCRIM, ALUMINUM FOIL AND VINYL FILM. ACCEPTABLE MANUFACTURERS ARE CERTIANTEED, KNAUF OR OWENS-CORNING. INSTALL DUCT WRAP INSULATION PER MANUFACTURERS' INSTRUCTIONS.
- INTERIOR DUCTWORK TO BE INSULATED WITH DUCT WRAP INSULATION. ALL SUPPLY DUCTS TO HAVE 3" MIN. THICKNESS (R-8) INSULATION AND ALL RETURN AND OUTSIDE AIR DUCTS TO HAVE 2" MIN. INSULATION.

TESTING, ADJUSTING AND BALANCING (TAB)

- TAB TO BE PERFORMED BY AN INDEPENDENT ENTITY, CERTIFIED BY AABC OR NEBB.
- PERFORM TESTING AND BALANCING PROCEDURES PER AABC'S "NATIONAL STANDARDS FOR TOTAL SYSTEM BALANCE" OR NEBB'S "PROCEDURAL STANDARDS FOR TESTING, ADJUSTING, AND BALANCING OF ENVIRONMENTAL SYSTEMS".



2902 NORTH FLORES
SAN ANTONIO, TEXAS 78212
210.393.1840 PHONE
SAN ANTONIO - RGV
TBPE FIRM REGISTRATION NO. 13361



04-12-18

CASSIANO HOMES
PARTIAL REMODEL
2919 S LAREDO ST. SAN ANTONIO, TX 78207

ISSUE DATE

11-28-2017

REVISIONS:

04-12-18 OWNER REVISIONS

MECHANICAL SYMBOLS & ABBREVIATIONS

SHEET:

M0.0

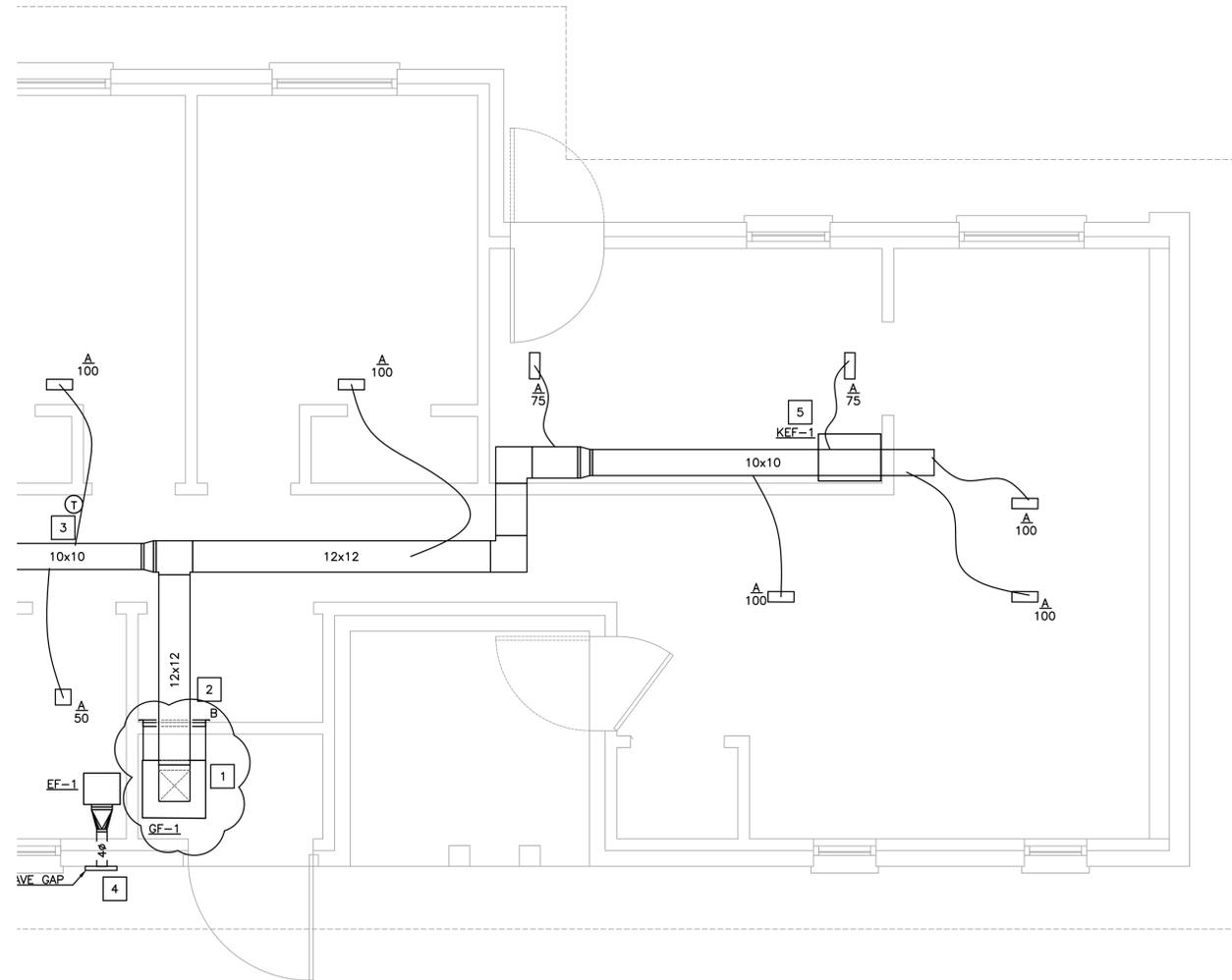

1 MECHANICAL PLAN - UNIT 942
3/8" = 1'-0"

MECHANICAL GENERAL NOTES:

1. CONTRACTOR SHALL BALANCE EACH DEVICE WITH THE CFM SHOWN ON PLAN.
2. NEW PIPING AND DUCTWORK SHOWN ON PLAN ARE SCHEMATIC ONLY. CONTRACTOR SHALL COORDINATE WITH OTHER TRADES FOR PIPING AND DUCTWORK ROUTING, OFFSET AND RUN PIPING, DUCTWORK INSIDE THE STRUCTURE IF REQUIRED. PROVIDE ANY EXTRA PIPING, DUCTWORK, FITTINGS, INSULATIONS AND OTHER ACCESSORIES IN ORDER TO COMPLETE THE INSTALLATION.
3. COORDINATE LOCATIONS AND SIZES OF ROOF OPENINGS WITH OWNER AND STRUCTURE ENGINEERS.
4. EQUIPMENT SIZES, DIMENSIONS AND REQUIRED CONNECTIONS SHALL BE VERIFIED WITH THE ACTUAL EQUIPMENT SELECTED VENDOR DRAWINGS BEFORE FABRICATION OF DUCTWORK, PIPING, ETC...
5. DUCT SIZES SHOWN ON PLANS ARE CLEAR INSIDE AIR STREAM DIMENSIONS.
6. CONTRACTOR SHALL COORDINATE ALL ELECTRICAL REQUIREMENTS FOR ALL HVAC BASED ON ACTUAL EQUIPMENT SELECTED PRIOR TO INSTALLATION.
7. CONTRACTOR SHALL COORDINATE EQUIPMENT WEIGHTS AND SUPPORTS BASED ON ACTUAL EQUIPMENT SELECTED.
8. COORDINATE WITH ARCHITECT AND OWNER FOR LOCATION OF CONDENSING UNIT.
9. REFER TO M.3.0 FOR DIFFUSERS AND RETURNS NECK SIZES.

KEYED NOTES: MECHANICAL

- 1 LOCATE CONCEAL INDOOR UNIT AS SHOWN ON DRAWINGS. VERIFY CLEARANCES. COORDINATE WITH ARCHITECTURE DRAWINGS PRIOR TO INSTALLATION.
- 2 ROUTE SUPPLY AND RETURN DUCT AS SHOWN. TRANSITIONS AS REQUIRED. FIELD ADJUST TO ACCOMMODATE WITH STRUCTURE CLEARANCE.
- 3 MOUNT THERMOSTAT ON WALL. COORDINATE EXACT LOCATION WITH ARCHITECT.
- 4 INTERCONNECT EXHAUST FAN WITH LIGHTS IN THIS ROOM. FAN SHALL BE SUSPENDED FROM STRUCTURE ABOVE. VERIFY EXACT LOCATION OF STRUCTURAL MEMBERS PRIOR TO INSTALLATION. PROVIDE EAVE CAP EQUAL TO GREENHECK EL-10X3.
- 5 PROVIDE KITCHEN HOOD AS SCHEDULED. UNIT SHALL HAVE INTEGRAL CONTROLS.



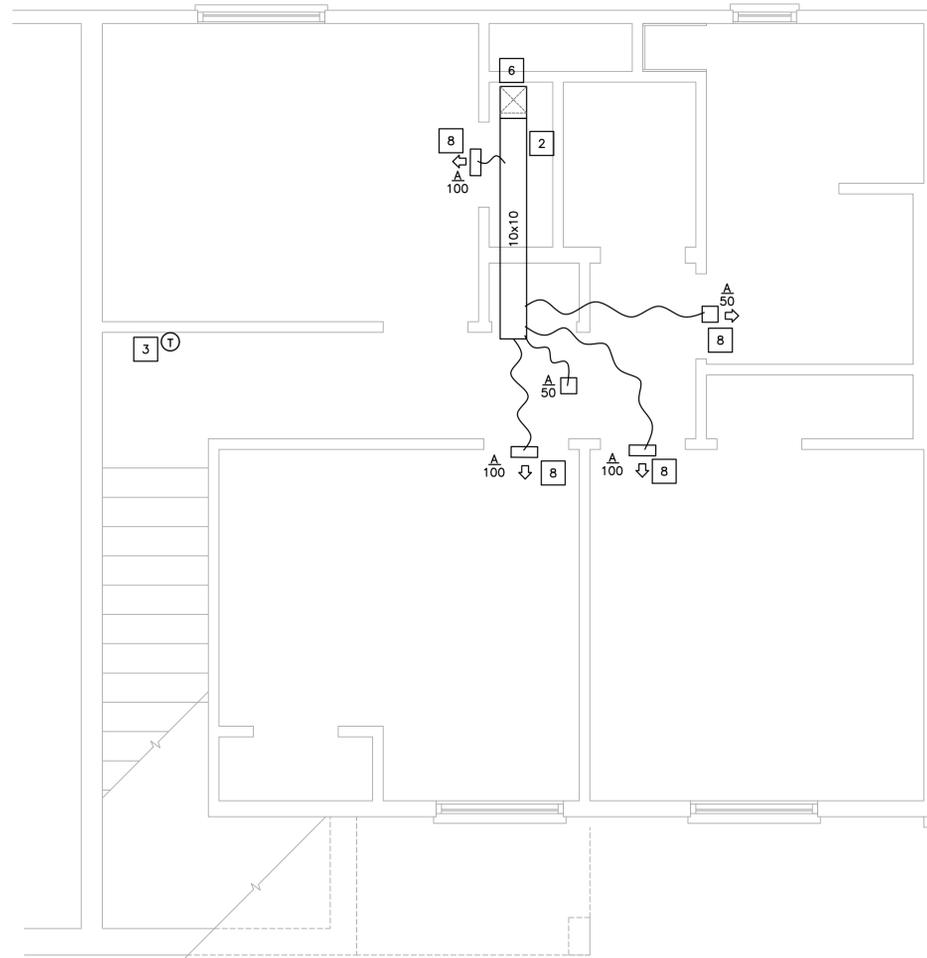
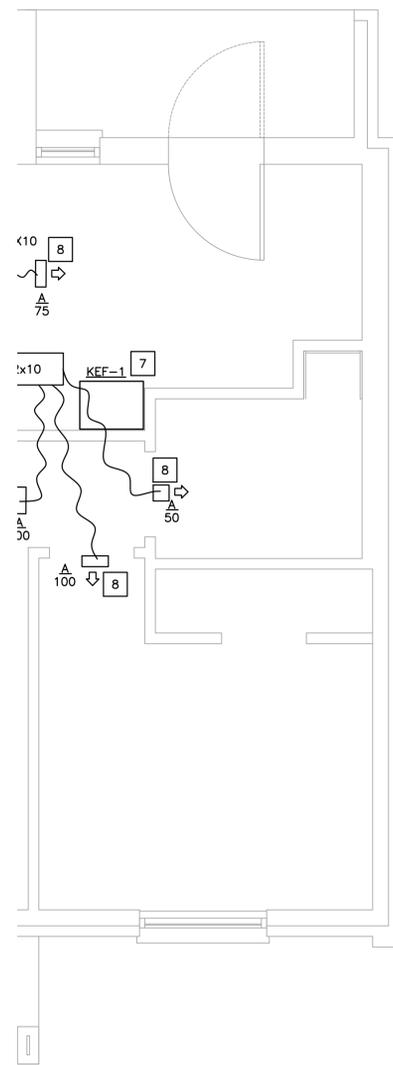

MR - UNIT 1818

2 MECHANICAL PLAN 2ND FLOOR - UNIT 1818
3/8" = 1'-0"

MECHANICAL GENERAL NOTES:

1. CONTRACTOR SHALL BALANCE EACH DEVICE WITH THE CFM SHOWN ON PLAN.
2. NEW PIPING AND DUCTWORK SHOWN ON PLAN ARE SCHEMATIC ONLY. CONTRACTOR SHALL COORDINATE WITH OTHER TRADES FOR PIPING AND DUCTWORK ROUTING. OFFSET AND RUN PIPING, DUCTWORK INSIDE THE STRUCTURE IF REQUIRED. PROVIDE ANY EXTRA PIPING, DUCTWORK, FITTINGS, INSULATIONS AND OTHER ACCESSORIES IN ORDER TO COMPLETE THE INSTALLATION.
3. COORDINATE LOCATIONS AND SIZES OF ROOF OPENINGS WITH OWNER AND STRUCTURE ENGINEERS.
4. EQUIPMENT SIZES, DIMENSIONS AND REQUIRED CONNECTIONS SHALL BE VERIFIED WITH THE ACTUAL EQUIPMENT SELECTED VENDOR DRAWINGS BEFORE FABRICATION OF DUCTWORK, PIPING, ETC...
5. DUCT SIZES SHOWN ON PLANS ARE CLEAR INSIDE AIR STREAM DIMENSIONS.
6. CONTRACTOR SHALL COORDINATE ALL ELECTRICAL REQUIREMENTS FOR ALL HVAC BASED ON ACTUAL EQUIPMENT SELECTED PRIOR TO INSTALLATION.
7. CONTRACTOR SHALL COORDINATE EQUIPMENT WEIGHTS AND SUPPORTS BASED ON ACTUAL EQUIPMENT SELECTED.
8. COORDINATE WITH ARCHITECT AND OWNER FOR LOCATION OF CONDENSING UNIT.
9. REFER TO M3.0 FOR DIFFUSERS AND RETURNS NECK SIZES.

KEYED NOTES: MECHANICAL

- 1 LOCATE CONCEAL INDOOR UNIT AS SHOWN ON DRAWINGS. VERIFY CLEARANCES. COORDINATE WITH ARCHITECTURE DRAWINGS PRIOR TO INSTALLATION.
- 2 ROUTE SUPPLY AND RETURN DUCT AS SHOWN. TRANSITIONS AS REQUIRED. FIELD ADJUST TO ACCOMMODATE WITH STRUCTURE CLEARANCE.
- 3 MOUNT THERMOSTAT ON WALL. COORDINATE EXACT LOCATION WITH ARCHITECT.
- 4 NOT USED.
- 5 REFER TO 2/M2.1 FOR CONTINUATION.
- 6 REFER TO 1/M2.1 FOR CONTINUATION.
- 7 PROVIDE KITCHEN HOOD AS SCHEDULED. UNIT SHALL HAVE INTEGRAL CONTROLS.
- 8 MOUNT AS SIDE DIFFUSER ON WALL.

HMB
ENGINEERING
CONSULTANTS

2902 NORTH FLORES
SAN ANTONIO, TEXAS 78212
210.393.1840 PHONE
SAN ANTONIO - RGV
TBPE FIRM REGISTRATION NO. 13361

SPRINKLE & CO.
ARCHITECTS
1102-257-7722
www.sprinkleco.com



CASSIANO HOMES
PARTIAL REMODEL
2919 S LAREDO ST. SAN ANTONIO, TX 78207

ISSUE DATE:
11-28-2017

REVISIONS:
04-12-18 OWNER REVISIONS
07-25-18 COSA COMMENTS
MECHANICAL
PLAN

SHEET:
M2.1

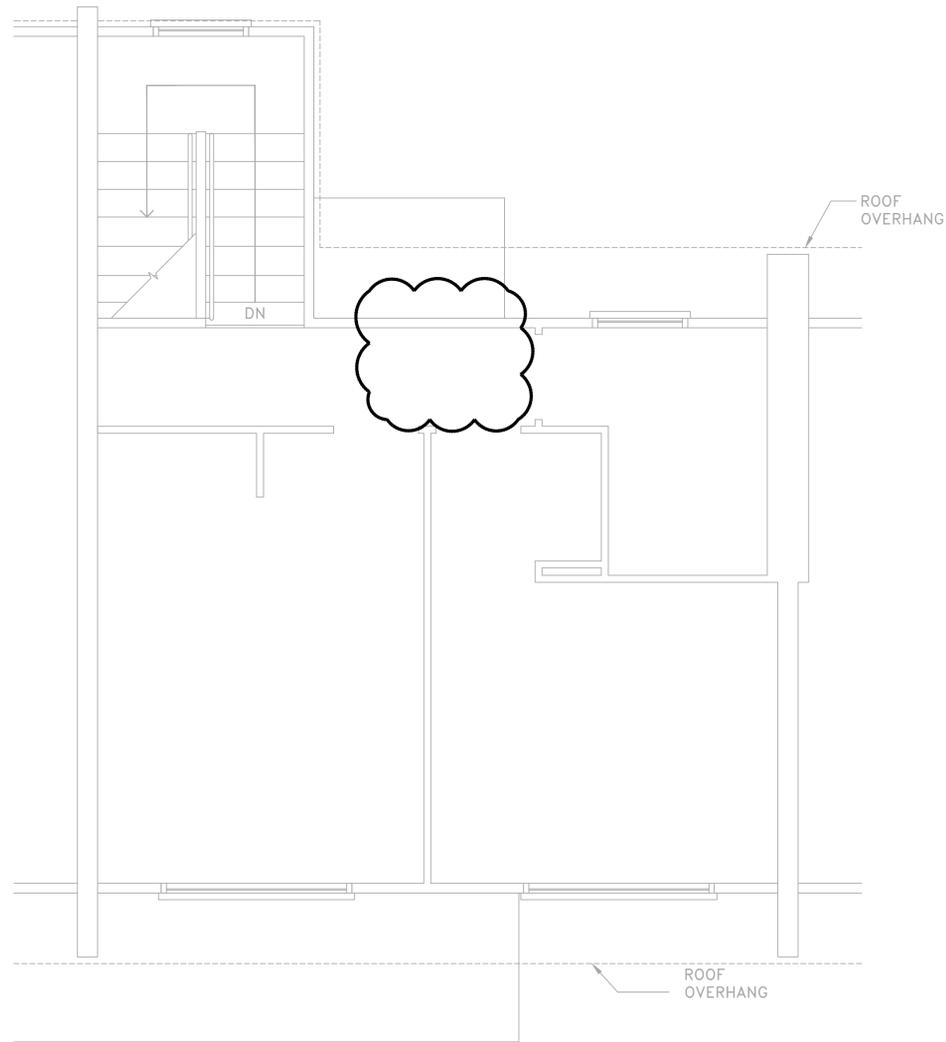
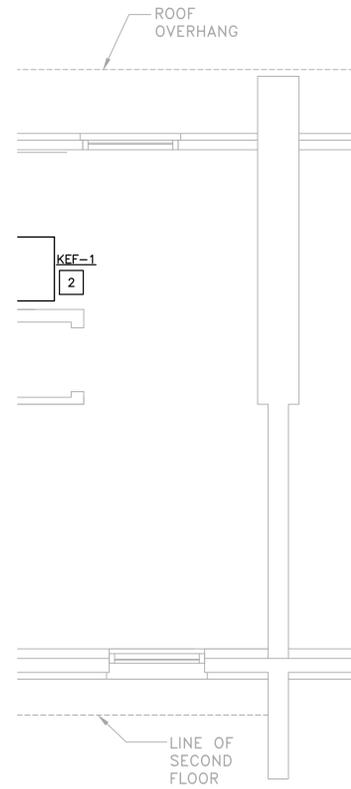

MECHANICAL GENERAL NOTES:

1. CONTRACTOR SHALL BALANCE EACH DEVICE WITH THE CFM SHOWN ON PLAN.
2. NEW PIPING AND DUCTWORK SHOWN ON PLAN ARE SCHEMATIC ONLY. CONTRACTOR SHALL COORDINATE WITH OTHER TRADES FOR PIPING AND DUCTWORK ROUTING. OFFSET AND RUN PIPING, DUCTWORK INSIDE THE STRUCTURE IF REQUIRED. PROVIDE ANY EXTRA PIPING, DUCTWORK, FITTINGS, INSULATIONS AND OTHER ACCESSORIES IN ORDER TO COMPLETE THE INSTALLATION.
3. COORDINATE LOCATIONS AND SIZES OF ROOF OPENINGS WITH OWNER AND STRUCTURE ENGINEERS.
4. EQUIPMENT SIZES, DIMENSIONS AND REQUIRED CONNECTIONS SHALL BE VERIFIED WITH THE ACTUAL EQUIPMENT SELECTED VENDOR DRAWINGS BEFORE FABRICATION OF DUCTWORK, PIPING, ETC...
5. DUCT SIZES SHOWN ON PLANS ARE CLEAR INSIDE AIR STREAM DIMENSIONS.
6. CONTRACTOR SHALL COORDINATE ALL ELECTRICAL REQUIREMENTS FOR ALL HVAC BASED ON ACTUAL EQUIPMENT SELECTED PRIOR TO INSTALLATION.
7. CONTRACTOR SHALL COORDINATE EQUIPMENT WEIGHTS AND SUPPORTS BASED ON ACTUAL EQUIPMENT SELECTED.
8. THERMOSTAT SHALL BE INSTALLED AND SPECIFIED AS PER 'WILLIAMS' SPACE HEATER MANUFACTURER RECOMMENDATIONS.

KEYED NOTES: MECHANICAL

- 1 NOT USED.
- 2 PROVIDE KITCHEN HOOD AS SCHEDULED. UNIT SHALL HAVE INTEGRAL CONTROLS.
- 3 COORDINATE SPACE HEATER LOCATION WITH OWNER AND ARCHITECT BEFORE MOUNTING. CONTRACTOR SHALL EXTEND NEW FLUE PIPING TO EXISTING FLUE WHEN POSSIBLE OTHER WISE CONTRACTOR SHALL PROVIDE NEW FLUE THRU ROOF. REFER TO DETAIL.

OR - UNIT 103 & 2404

2 MECHANICAL PLAN 2ND FLOOR - UNIT 103 & 2404
3/8" = 1'-0"

HMB
ENGINEERING
 CONSULTANTS

2902 NORTH FLORES
 SAN ANTONIO, TEXAS 78212
 210.393.1840 PHONE
 SAN ANTONIO - RGV
 TBPE FIRM REGISTRATION NO. 13361

SPRINKLE & CO.
 ARCHITECTS
 11000 N. LOOP WEST, SUITE 1000
 DALLAS, TEXAS 75243
 TEL: 214-227-7722 FAX: 214-227-7722



CASSIANO HOMES
PARTIAL REMODEL
 2919 S LAREDO ST. SAN ANTONIO, TX 78207

ISSUE DATE:	11-28-2017
REVISIONS:	04-12-18 OWNER REVISIONS 07-25-18 COSA COMMENTS
SHEET:	M2.2

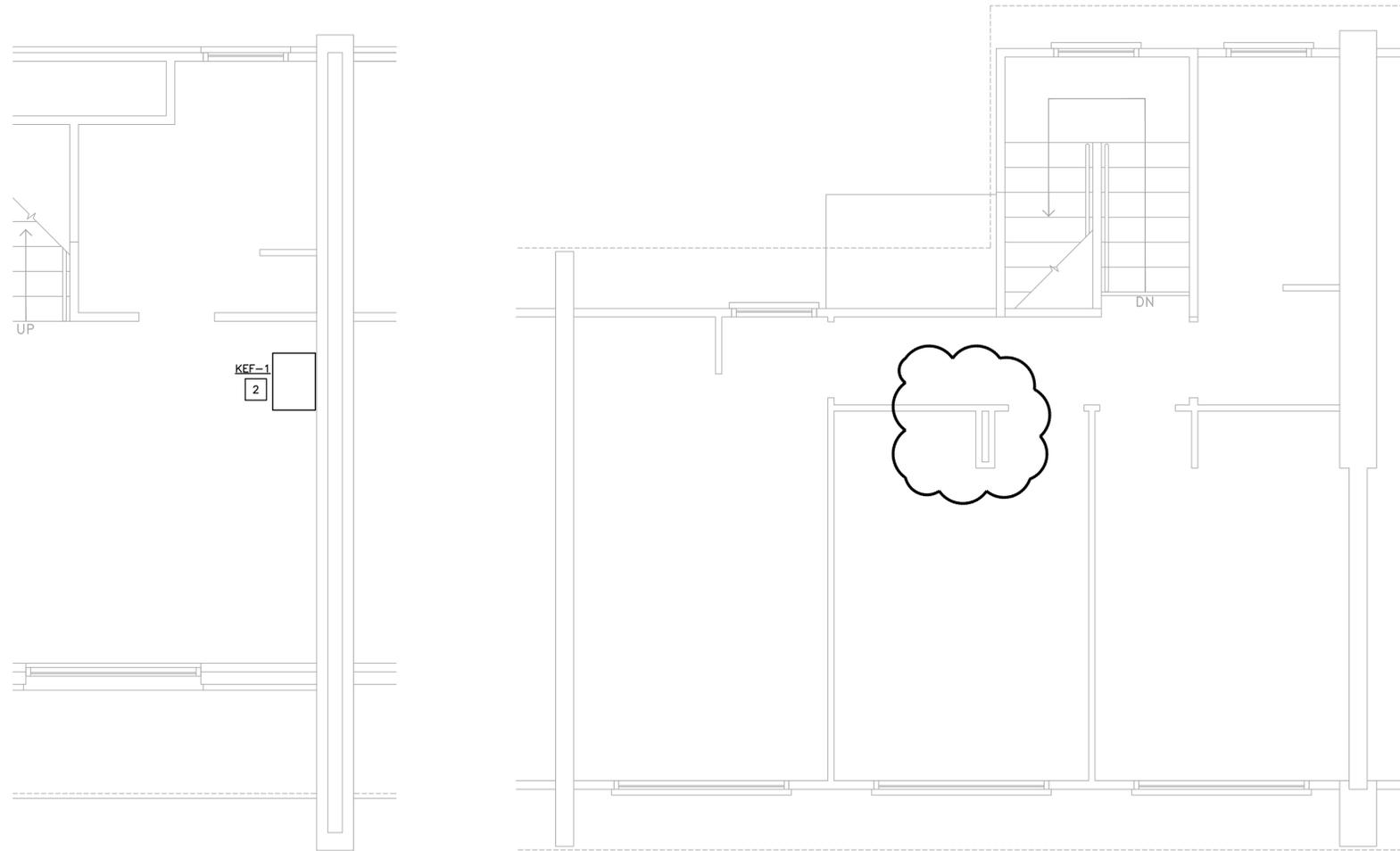

OR - UNIT 1523 & 3023

2 MECHANICAL PLAN 2ND FLOOR - UNIT 1523 & 3023
3/8" = 1'-0"

MECHANICAL GENERAL NOTES:

1. CONTRACTOR SHALL BALANCE EACH DEVICE WITH THE CFM SHOWN ON PLAN.
2. NEW PIPING AND DUCTWORK SHOWN ON PLAN ARE SCHEMATIC ONLY. CONTRACTOR SHALL COORDINATE WITH OTHER TRADES FOR PIPING AND DUCTWORK ROUTING. OFFSET AND RUN PIPING, DUCTWORK INSIDE THE STRUCTURE IF REQUIRED. PROVIDE ANY EXTRA PIPING, DUCTWORK, FITTINGS, INSULATIONS AND OTHER ACCESSORIES IN ORDER TO COMPLETE THE INSTALLATION.
3. COORDINATE LOCATIONS AND SIZES OF ROOF OPENINGS WITH OWNER AND STRUCTURE ENGINEERS.
4. EQUIPMENT SIZES, DIMENSIONS AND REQUIRED CONNECTIONS SHALL BE VERIFIED WITH THE ACTUAL EQUIPMENT SELECTED VENDOR DRAWINGS BEFORE FABRICATION OF DUCTWORK, PIPING, ETC...
5. DUCT SIZES SHOWN ON PLANS ARE CLEAR INSIDE AIR STREAM DIMENSIONS.
6. CONTRACTOR SHALL COORDINATE ALL ELECTRICAL REQUIREMENTS FOR ALL HVAC BASED ON ACTUAL EQUIPMENT SELECTED PRIOR TO INSTALLATION.
7. CONTRACTOR SHALL COORDINATE EQUIPMENT WEIGHTS AND SUPPORTS BASED ON ACTUAL EQUIPMENT SELECTED.
8. THERMOSTAT SHALL BE INSTALLED AND SPECIFIED AS PER WILLIAMS' SPACE HEATER MANUFACTURER RECOMMENDATIONS.

KEYED NOTES: MECHANICAL

- 1 NOT USED
- 2 PROVIDE KITCHEN HOOD AS SCHEDULED. UNIT SHALL HAVE INTEGRAL CONTROLS.
- 3 COORDINATE SPACE HEATER LOCATION WITH OWNER AND ARCHITECT BEFORE MOUNTING. CONTRACTOR SHALL EXTEND NEW FLUE PIPING TO EXISTING FLUE WHEN POSSIBLE OTHER WISE CONTRACTOR SHALL PROVIDE NEW FLUE THRU ROOF. REFER TO DETAIL.
- 4 ROUTE FLUE IN THIS WALL.

HMB
ENGINEERING
 CONSULTANTS

2902 NORTH FLORES
 SAN ANTONIO, TEXAS 78212
 210.393.1840 PHONE
 SAN ANTONIO - RG
 TBPE FIRM REGISTRATION NO. 13361

SPRINKLE & CO.
 ARCHITECTS
 11000 N. LOOP W. SUITE 1000
 DALLAS, TX 75243
 PH: 214-227-7722



CASSIANO HOMES
PARTIAL REMODEL
 2919 S LAREDO ST. SAN ANTONIO, TX 78207

ISSUE DATE:
 11-28-2017

REVISIONS:
 04-12-18 OWNER REVISIONS
 07-25-18 COSA COMMENTS
MECHANICAL PLAN

SHEET:
M2.3

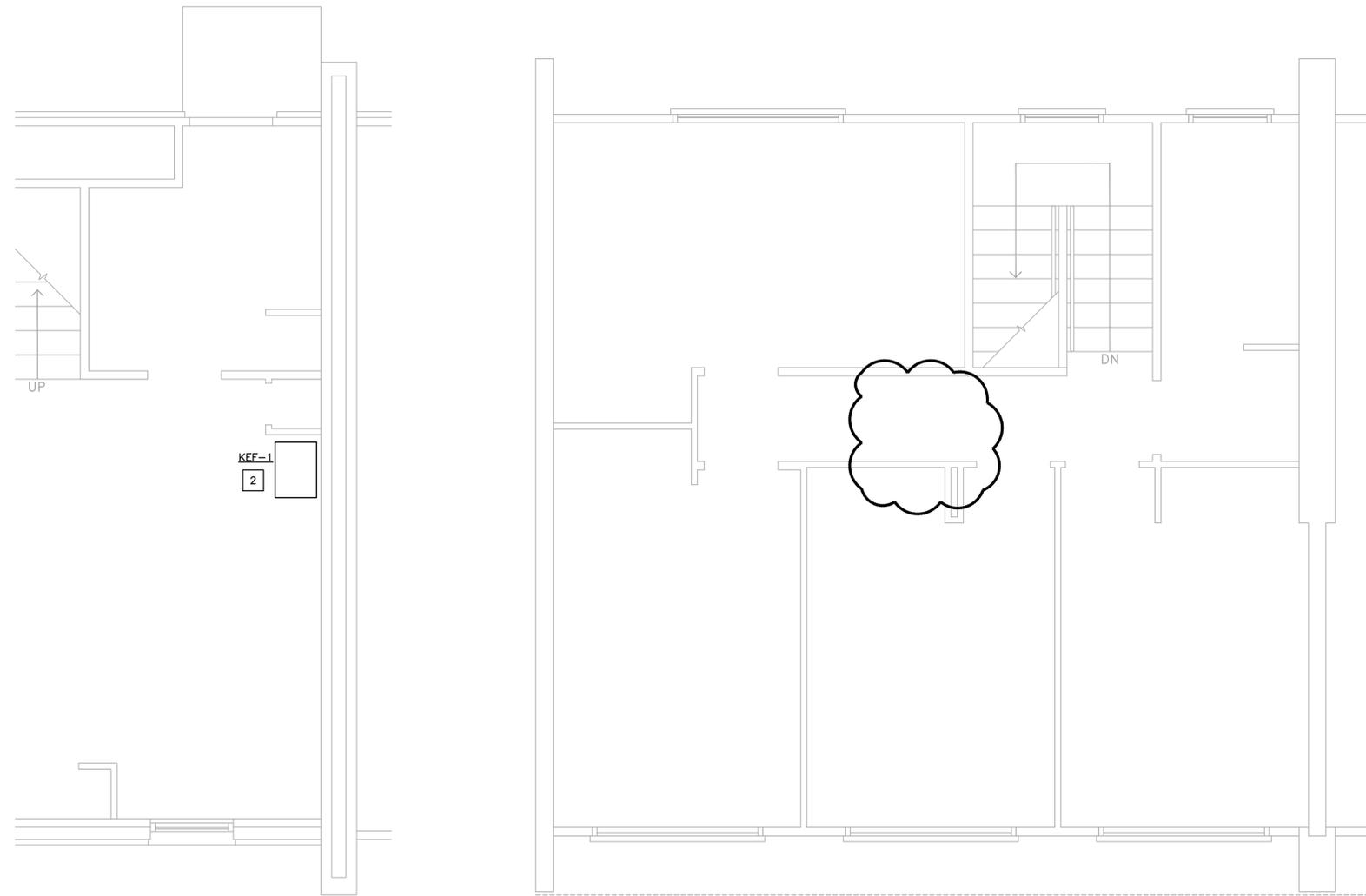

OR - UNIT 1501

2 MECHANICAL PLAN 2ND FLOOR - UNIT 1501
 $\frac{3}{8}'' = 1'-0''$

MECHANICAL GENERAL NOTES:

1. CONTRACTOR SHALL BALANCE EACH DEVICE WITH THE CFM SHOWN ON PLAN.
2. NEW PIPING AND DUCTWORK SHOWN ON PLAN ARE SCHEMATIC ONLY. CONTRACTOR SHALL COORDINATE WITH OTHER TRADES FOR PIPING AND DUCTWORK ROUTING. OFFSET AND RUN PIPING, DUCTWORK INSIDE THE STRUCTURE IF REQUIRED. PROVIDE ANY EXTRA PIPING, DUCTWORK, FITTINGS, INSULATIONS AND OTHER ACCESSORIES IN ORDER TO COMPLETE THE INSTALLATION.
3. COORDINATE LOCATIONS AND SIZES OF ROOF OPENINGS WITH OWNER AND STRUCTURE ENGINEERS.
4. EQUIPMENT SIZES, DIMENSIONS AND REQUIRED CONNECTIONS SHALL BE VERIFIED WITH THE ACTUAL EQUIPMENT SELECTED VENDOR DRAWINGS BEFORE FABRICATION OF DUCTWORK, PIPING, ETC...
5. DUCT SIZES SHOWN ON PLANS ARE CLEAR INSIDE AIR STREAM DIMENSIONS.
6. CONTRACTOR SHALL COORDINATE ALL ELECTRICAL REQUIREMENTS FOR ALL HVAC BASED ON ACTUAL EQUIPMENT SELECTED PRIOR TO INSTALLATION.
7. CONTRACTOR SHALL COORDINATE EQUIPMENT WEIGHTS AND SUPPORTS BASED ON ACTUAL EQUIPMENT SELECTED.
8. THERMOSTAT SHALL BE INSTALLED AND SPECIFIED AS PER 'WILLIAMS' SPACE HEATER MANUFACTURER RECOMMENDATIONS.

KEYED NOTES: MECHANICAL

- 1 NOT USED.
- 2 PROVIDE KITCHEN HOOD AS SCHEDULED. UNIT SHALL HAVE INTEGRAL CONTROLS.
- 3 COORDINATE SPACE HEATER LOCATION WITH OWNER AND ARCHITECT BEFORE MOUNTING. CONTRACTOR SHALL EXTEND NEW FLUE PIPING TO EXISTING FLUE WHEN POSSIBLE OTHER WISE CONTRACTOR SHALL PROVIDE NEW FLUE THRU ROOF. REFER TO DETAIL.
- 4 ROUTE FLUE IN THIS WALL.

HMB
ENGINEERING
 CONSULTANTS

2902 NORTH FLORES
 SAN ANTONIO, TEXAS 78212
 210.393.1840 PHONE
 SAN ANTONIO - RGV
 TBPE FIRM REGISTRATION NO. 13361

SPRINKLE & CO.
 ARCHITECTS
 11000 N. LOOP WEST, SUITE 1000
 DALLAS, TEXAS 75243
 TEL: 214.227.7722



07-25-18

CASSIANO HOMES
PARTIAL REMODEL
 2919 S LAREDO ST. SAN ANTONIO, TX 78207

ISSUE DATE:
 11-28-2017

REVISIONS:
 04-12-18 OWNER REVISIONS
 07-25-18 COSA COMMENTS
MECHANICAL PLAN

SHEET:
M2.4

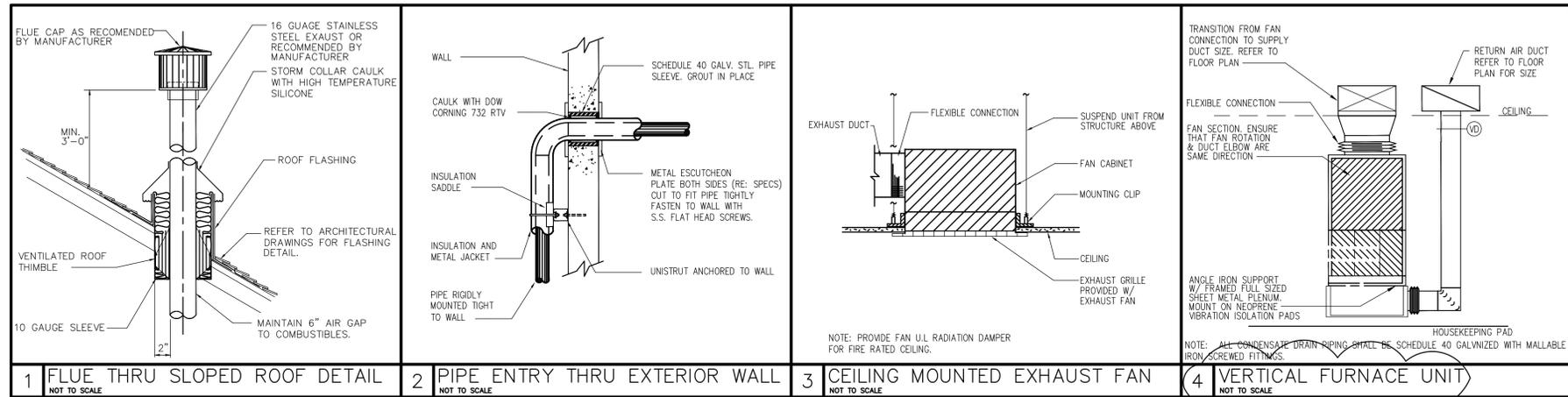

MECHANICAL FAN SCHEDULE												
TAG	FLOW RATE CFM	STATIC PRESSURE		MOTOR DATA		ELECTRICAL DATA			MAXIMUM		BASIS OF DESIGN MANUFACTURER/ MODEL OR SERIES	NOTES
		EXTERNAL IN WG	INTERNAL IN WG	LOAD HP	SPEED RPM	MCA AMPS	MOCF AMPS	VOLTAGE	LOUDDNESS SONES			
KEF-1	190	.05	-	-	2.5	15	120	6.50	BROAN	F403001	2,3	

NOTES:
 1. INTERLOCK WITH LIGHTS IN ROOM.
 2. PROVIDE FACTORY MOUNTED AND INSTALLED DISCONNECT.
 3. UNIT SHALL HAVE INTEGRAL CONTROLS.

MECHANICAL EQUIPMENT (GAS HEAT) SCHEDULE				
TAG	BASIS OF DESIGN			NOTES
	MANUFACTURER	MODEL OR SERIES	VOLTAGE	
GF-1	AMERISTAR	M801P060AU36AAB	120	
GF-2	AMERISTAR	M801P060AU36AAB	120	

MECHANICAL AIR TERMINAL DEVICES SCHEDULE						
TAG	SIZE	DESCRIPTION	CONSTRUCTION	BASIS OF DESIGN		NOTES
			FINISH	MANUFACTURER	MODEL OR SERIES	
A	-	PROVIDE BY OWNER	-	-	-	-
B	24X24	FIXED DEFLECTION RETURN GRILLE, WITH FILTER FRAME	STEEL	KRUEGER	S80	ALL
C	30X12	FIXED DEFLECTION RETURN GRILLE, WITH FILTER FRAME	STEEL	KRUEGER	S80	ALL

NOTES:
 1. PROVIDE STANDARD WHITE FINISH FOR ALL AIR DEVICES UNLESS NOTED OTHERWISE ON PLAN.
 2. PAINT ALL SURFACES VISIBLE THROUGH FACE OF RETURN AIR GRILLES FLAT BLACK. THIS SHALL INCLUDE PIPING, CONDUIT, DUCTWORK, AND STRUCTURAL MEMBERS.
 3. PROVIDE FRAME FOR MOUNTING AIR DEVICE IN LAY-IN GRID CEILING UNLESS REFLECTED CEILING PLAN INDICATES HARD CEILING. IN AREAS WITH HARD CEILINGS, PROVIDE FRAMES FOR SURFACE MOUNTING.
 4. UNLESS OTHERWISE NOTED, BRANCH DUCTS SERVING AIR DEVICES SHALL BE SAME SIZE AS NECK OF AIR DEVICE.
 5. AIR DEVICE SHALL BE OF GALVANIZED FINISH WHEN INSTALLED ON EXPOSED DUCTWORK.

GAS UNIT HEATER SCHEDULE		
MARK	SH-1	-
SERVES	HOME	-
BTU/HR	50000	-
VOLTS/PHASE/HERTZ	120/1/60	-
AMPS	1	-
MANUFACTURER	WILLIAMS	-
MODEL NO.	5008632	-
WEIGHT	NA	-
NOTES	1	-

NOTES:
 1. SHALL INCLUDE WALL MOUNTED THERMOSTAT, MANUAL RESET HIGH LIMIT, AND WALL BRACKET.

PLUMBING SYMBOLS AND ABBREVIATIONS

(NOT ALL OF THE SYMBOLS SHOWN MAY BE USED ON THE PROJECT.)

VIATION	SYMBOL	DESCRIPTION	ABBREVIATION	SYMBOL	DESCRIPTION	ABBREVIATION	ABBREVIATIONS	ABBREVIATIONS
RT		OUTSIDE YOLK & STEM GATE VALVE	OSY		UPRIGHT FIRE SPRINKLER HEAD	-	A	MAX
J		GATE VALVE	GV		FIRE HOSE RACK	FHR	AC	MPS
WASTE		GLOBE VALVE	GLV		AUTOMATIC SPRINKLER PIPE	-	ACU	MTHW
W, SS		ANGLE VALVE	AV		DRY PIPE SPRINKLER	-	AHU	HG
W, SS		BALL VALVE	BV		PREACTION SPRINKLER PIPE	-	AHP	MPH
		BUTTERFLY VALVE	BFV		FIRE HOSE VALVE	FHV	AC	MIN
		GAS COCK, GAS STOP	-		FIRE HOSE CABINET (SURFACE-MOUNTED)	FHC	ALT	N
		BALANCING VALVE (SPECIFY TYPE)	BLV		FIRE HOSE CABINET (RECESSED)	FHC	AMB	NC
		CHECK VALVE	CV		CLEANOUT PLUG	CO	ANSI	NO
		PLUG VALVE	PV		FLOOR CLEANOUT	FCO	AWG	MTHW
		ACCESS PANEL LOCATION	AP		WALL CLEANOUT	WCO	AMP	HG
		PLUMBING FIXTURE DESIGNATION	-		YARD CLEANOUT OR CLEANOUT TO GRADE	CO	ANG	MPH
		SOLENOID VALVE	-		FLOOR DRAIN WITH P-TRAP	FD	ANG	MIN
R		MOTOR-OPERATED VALVE (SPECIFY TYPE)	-		PITCH DOWN OR UP-IN DIRECTION OF ARROW	-	ANG	N
TR		PRESSURE-REDUCING VALVE	PRV		FLOW-IN DIRECTION OF ARROW	-	ANG	NC
W, TW		PRESSURE-RELIEF VALVE	RV		POINT OF CONNECTION	POC	ANG	NO
TR, TWR		TEMPERATURE-PRESSURE-RELIEF VALVE	TPV		STEAM TRAP (ALL TYPES)	-	ANG	NA
S		REDUCED ZONE BACKFLOW PREVENTER	RZBP		FUNNEL FLOOR DRAIN	FDD	ANG	NIC
R		DOUBLE-CHECK BACKFLOW PREVENTER	DCBP		FLOOR SINK (3/4 GRATE)	FS	ANG	NTS
		HOSE BIBB	HB		FLOOR SINK (1/2 GRATE)	FS	ANG	NO.
		RECESSED-BOX HOSE BIBB OR WALL HYDRANT	WH		SOIL/VENT STACK DESIGNATION	-	ANG	O
		VALVE IN YARD BOX (VALVE TYPE SYMBOL AS REQUIRED FOR VALVE USE)	YB		REFERENCE: DETAIL NUMBER	-	ANG	OZ
		UNION (SCREW)	-		REFERENCE: SHEET NUMBER	-	ANG	OA
		UNION (FLANGED)	-		UPRIGHT SPRINKLER	-	ANG	P
		STRAINER (SPECIFY TYPE)	-		PENDENT SPRINKLER	-	ANG	PPM
		PIPE ANCHOR	PA		UPRIGHT SPRINKLER, NIPPLED UP	-	ANG	%
		PIPE GUIDE	-		PENDENT SPRINKLER, ON DROP NIPPLE	-	ANG	PH
		EXPANSION JOINT	EJ		SIDEWALL SPRINKLER	-	ANG	PI
		FLEXIBLE CONNECTOR	FC		PIPE HANGER	-	ANG	LB
		TEE	-		ALARM CHECK VALVE ASSEMBLY	-	ANG	PSF
		SIAMESE FIRE DEPARTMENT CONNECTION	-		DRY PIPE VALVE ASSEMBLY	-	ANG	PSI
		FREESTANDING SIAMESE FIRE DEPARTMENT CONNECTION	-		DELUGE VALVE ASSEMBLY	-	ANG	PSI
		WALL (SPECIFY NUMBERS AND SIZE OF OUTLETS)	-		PREACTION VALVE ASSEMBLY	-	ANG	PSIA
		FIRE PUMP / JOCKEY PUMP	-		EXISTING FIRE HYDRANT	-	ANG	PSIG
		TRAP PRIMER	TP		NEW FIRE HYDRANT	-	ANG	PRES
		PROPANE GAS	PG		WALL HYDRANT, TWO HOSE OUTLETS	-	ANG	Q

GENERAL PLUMBING NOTES:

- ALL WORK SHALL CONFORM TO ALL STATE AND LOCAL CODES, RULES AND REGULATIONS, AND ORDINANCES.
- PLUMBING PLANS ARE DIAGRAMMATIC ONLY. THEY ARE INTENDED TO INDICATE CAPACITY, SIZE, LOCATION, DIRECTION AND GENERAL ARRANGEMENT. WHERE NOT SPECIFICALLY SHOWN ON PLANS, CONTRACTOR SHALL APPLY PROFESSIONAL STANDARDS SUCH AS THAT OF THE AMERICAN SOCIETY OF PLUMBING ENGINEERS.
- WORK SHALL INCLUDE ALL LABOR, MATERIALS, PERMITS AND OTHER COSTS AS ARE NECESSARY FOR THE INSTALLATION OF A COMPLETE AND SATISFACTORY OPERATIONAL PLUMBING AND SANITARY SYSTEM. EQUIPMENT SHALL BE INSTALLED IN SUCH A MANNER AS TO MAINTAIN ITS LISTING AND THE MANUFACTURER'S GUARANTEES AND WARRANTIES.
- THIS CONTRACTOR SHALL COORDINATE WITH THE OTHER TRADES TO INSURE THAT EACH TRADE SHALL HAVE SUFFICIENT SPACE TO INSTALL THEIR EQUIPMENT (DUCTWORK, PIPING, ELECTRICAL, ETC.), ALONG WITH THE PLUMBING WORK.
- WHERE THE TERM "PROVIDE" IS USED, IT SHALL MEAN "FURNISH AND INSTALL". THE CONTRACTOR SHALL COORDINATE HIS WORK WITH ALL THE OTHER TRADES PRIOR TO THE FABRICATION, PURCHASE AND/OR INSTALLATION OF THE WORK.
- UNLESS NOTED, ALL MATERIALS SHALL BE NEW, COMPLETE, INCLUDE MANUFACTURER'S WARRANTY, AND BE U.L. APPROVED IF APPLICABLE. ALL WORK SHALL PRESENT A NEAT MECHANICAL APPEARANCE WHEN COMPLETED.
- FIELD VERIFY ALL DIMENSIONS. CONTRACTOR SHALL VERIFY ELEVATION OF UTILITY CONNECTIONS ON SITE PRIOR TO COMMENCING WORK. FINAL CONNECTION TO SITE UTILITIES SHALL BE BY THE PLUMBING CONTRACTOR.
- PIPING ROUTED THROUGH FOUNDATIONS SHALL BE SLEEVED AND INSTALLED IN ACCORDANCE WITH THE AMERICAN SOCIETY OF PLUMBING ENGINEERS STANDARDS.
- PLUMBING SYSTEM INSTALLER SHALL PROVIDE ALL STRUCTURAL MEMBERS, SUPPORT BRACKETS, FLASHING, HARDWARE, ETC., REQUIRED TO INSTALL A COMPLETE SYSTEM.
- DRAIN WASTE AND VENT PIPING SHALL BE CAST IRON.
- DOMESTIC WATER PIPING SHALL BE TYPE "L" COPPER.
- PLUMBING CONTRACTOR SHALL CERTIFY ALL WATER PIPING AND SPECIALTIES FREE FROM MICROBIAL CONTAMINATION BY SANITIZING THE PLUMBING SYSTEM BEFORE OCCUPATION OF BUILDING.
- EXPOSED FIXTURE TRIM SHALL BE CHROME PLATED BRASS. PROVIDE INDIVIDUAL STOPS FOR EACH HOT AND COLD WATER CONNECTION TO FIXTURES.
- ALL SANITARY PIPING CHANGES OF DIRECTION 45 DEGREES OR MORE SHALL BE ACCOMPLISHED BY USING 45 DEGREE 1/8 BEND ELBOWS UNLESS OTHERWISE NOTED.
- ALL SANITARY PIPING UNDER SLAB SHALL BE 2" OR LARGER.
- INSTALL HEAT TRAPS ON ALL WATER HEATERS, WHERE THE SYSTEM IS NOT RECIRCULATED.
- PROVIDE MAINTENANCE AND/OR OTHER CLEARANCES AT EACH PIECE OF EQUIPMENT AS REQUIRED OR RECOMMENDED BY THE EQUIPMENT MANUFACTURER. COORDINATE WITH GENERAL CONTRACTOR TO PROVIDE ANY ADDITIONAL SPACE REQUIRED FOR SUBMITTED EQUIPMENT.
- PROVIDE ACCESS DOORS IN INACCESSIBLE FINISHES FOR ALL VALVES TRAP PRIMER, ETC., THAT REQUIRES PERIODIC ADJUSTMENTS OR MAINTENANCE.
- THE CONTRACTOR SHALL BE RESPONSIBLE FOR THE SAFEKEEPING OF HIS OWN PROPERTY ON THE JOB SITE. OWNER ASSUMES NO RESPONSIBILITY FOR PROTECTION OF PROPERTY AGAINST FIRE THEFT OR ENVIRONMENTAL CONDITIONS.
- ALL MODEL NUMBERS INDICATED ARE PROVIDED TO ESTABLISH THE QUALITY LEVEL AND FEATURES REQUIRED. LISTED MANUFACTURERS AND OTHER PRIOR APPROVED EQUALS MAY BE SUBSTITUTED WHEN PROVIDED WITH EQUAL FEATURES, EITHER STANDARD OR AS ACCESSORIES. SUBSTITUTED AIR DEVICES AND PLUMBING FIXTURES MUST BE SIMILAR IN APPEARANCE TO THE ITEMS SPECIFICALLY INDICATED.
- ALL WORK SHALL BE PERFORMED IN A WORKMANLIKE MANNER. CLEAN THE SITE DAILY AND REMOVE FROM THE PREMISES ANY DIRT AND DEBRIS CAUSED BY THE WORK INCLUDED IN THIS CONTRACT.
- PROVIDE 1" ARMAFLEX INSULATION ON ALL HOT AND CIRCULATING WATER PIPING.



2902 NORTH FLORES
SAN ANTONIO, TEXAS 78212
210.393.1840 PHONE
SAN ANTONIO - RGV
TBE FIRM REGISTRATION NO. 13361



04-12-18

CASSIANO HOMES
PARTIAL REMODEL
2919 S LAREDO ST. SAN ANTONIO, TX 78207

ISSUE DATE:
11-28-2017

REVISIONS:
04-12-18 OWNER REVISIONS
PLUMBING SYMBOLS &
ABBREVIATIONS

SHEET:
P0.0

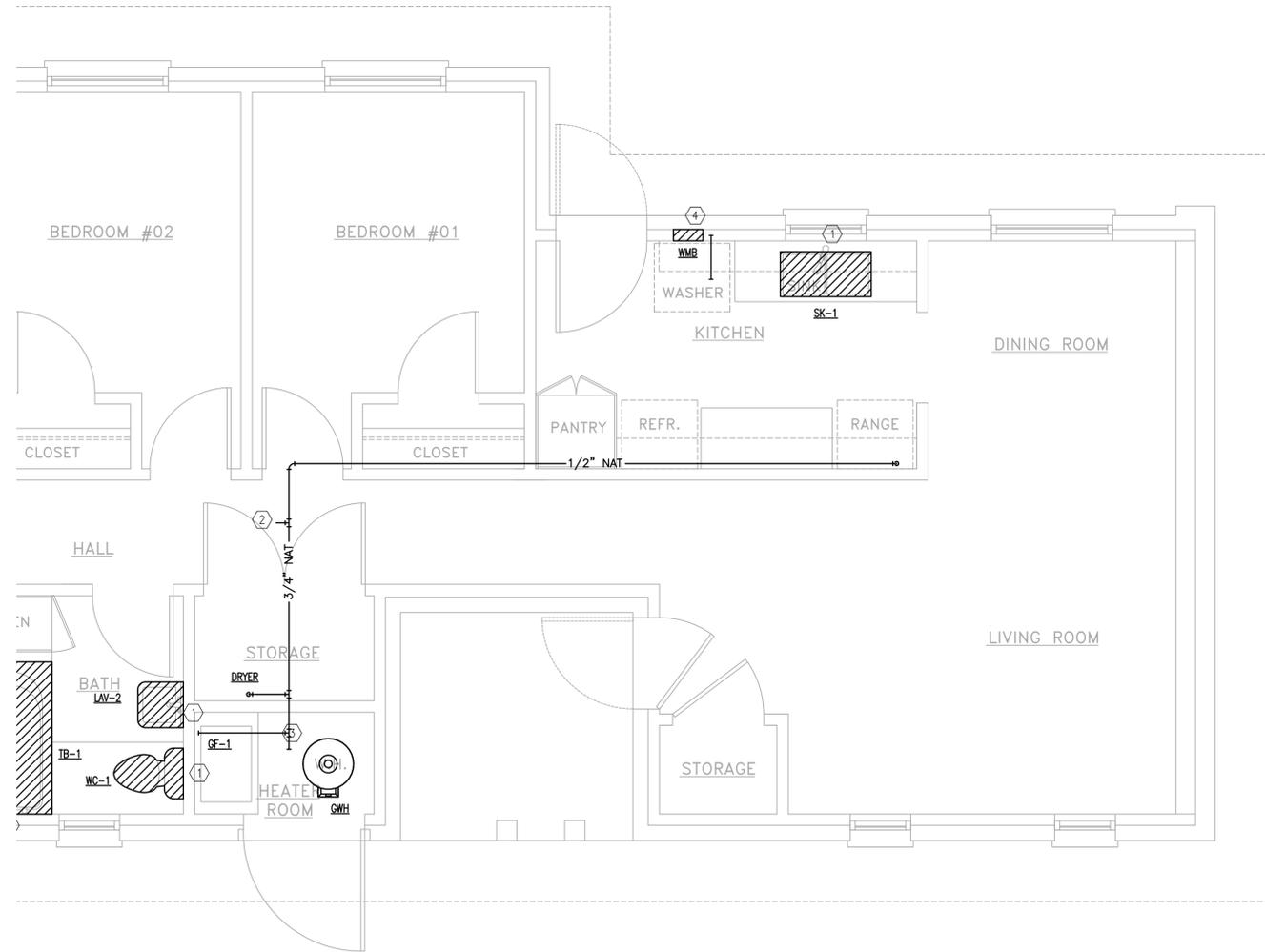

1 PLUMBING PLAN - UNIT 942
3/8" = 1'-0"

PLUMBING GENERAL NOTE:

1. CONTRACTOR SHALL PROVIDE LABOR AND MATERIALS TO MAKE THE NECESSARY CHANGES AND MODIFICATION TO NEW AND EXISTING PLUMBING FIXTURE/FIXTURES. REFER TO ARCHITECTURAL DRAWINGS FOR GENERAL DEMOLITION NOTES, DIMENSIONED FLOOR PLANS, MOUNTING HEIGHTS AND SCOPE OF WORK REQUIREMENTS.
2. CONTRACTOR PROVIDE NECESSARY MODIFICATION AND/OR EXTEND NEW WATER SUPPLY OR SANITARY WASTE AND VENT (CARRIER) TO NEW PLUMBING FIXTURE AND MAKE ALL FINAL CONNECTIONS.

PLUMBING RENOVATION KEYED NOTES:

- 1 APPROXIMATE POINT OF CONNECTION. CONTRACTOR SHALL FIELD VERIFY EXISTING LOCATION OF DOMESTIC WATER LINES AND OF SANITARY.
- 2 CONTRACTOR TO CONNECT GAS LINE APPROXIMATE 150' TO EXISTING GAS UTILITY METER. EXTEND FLUE TO EXISTING FLUE LOCATION.
- 3 CONTRACTOR TO EXTEND NEW DOMESTIC HOT WATER FROM NEW EWH TO EXISTING MAIN HOT WATER LINE.
- 4 CONNECT DOMESTIC WATER LINES AND SANITARY TO NEAR EXISTING LINES. FIELD VERIFY LOCATION AND COORDINATE WITH CONTRACTOR.

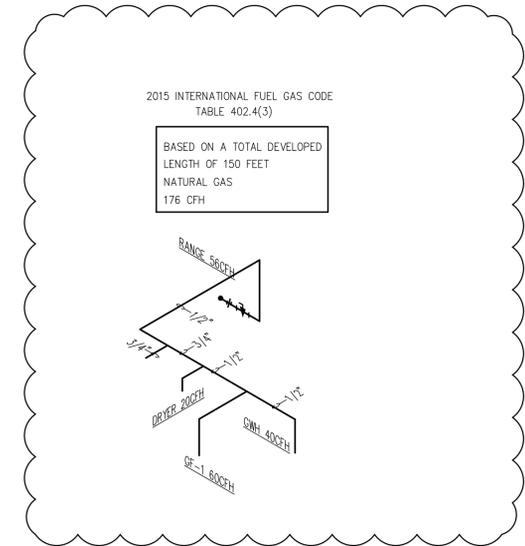

2 PLUMBING RISER - NATURAL GAS
N/S

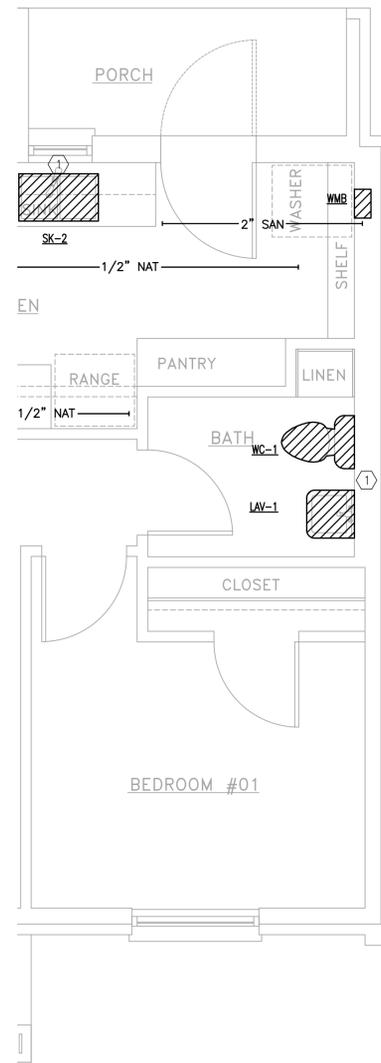

FLOOR - UNIT 1818

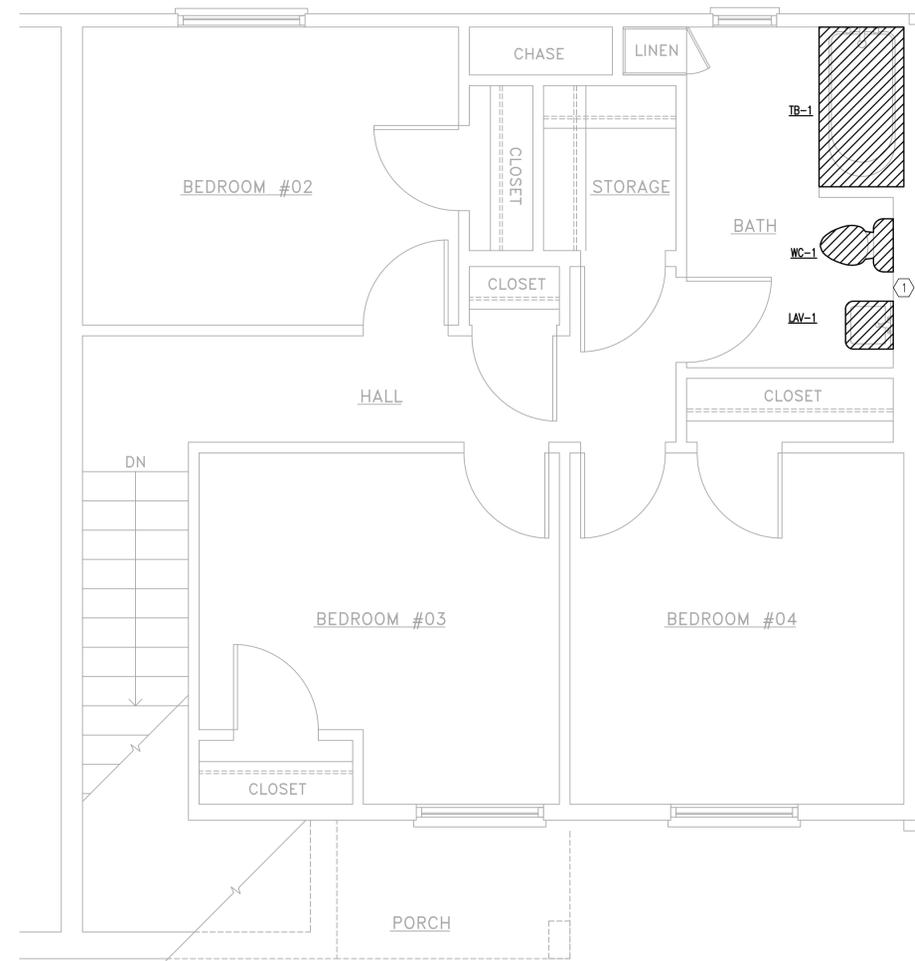

2 PLUMBING PLAN 2ND FLOOR - UNIT 1818
3/8" = 1'-0"

PLUMBING GENERAL NOTE:

1. CONTRACTOR SHALL PROVIDE LABOR AND MATERIALS TO MAKE THE NECESSARY CHANGES AND MODIFICATION TO NEW AND EXISTING PLUMBING FIXTURE/FIXTURES. REFER TO ARCHITECTURAL DRAWINGS FOR GENERAL DEMOLITION NOTES, DIMENSIONED FLOOR PLANS, MOUNTING HEIGHTS AND SCOPE OF WORK REQUIREMENTS.
2. CONTRACTOR PROVIDE NECESSARY MODIFICATION AND/OR EXTEND NEW WATER SUPPLY OR SANITARY WASTE AND VENT (CARRIER) TO NEW PLUMBING FIXTURE AND MAKE ALL FINAL CONNECTIONS.

PLUMBING RENOVATION KEYED NOTES:

1. APPROXIMATE POINT OF CONNECTION. CONTRACTOR SHALL FIELD VERIFY EXISTING LOCATION OF DOMESTIC WATER LINES AND OF SANITARY.
2. CONTRACTOR TO CONNECT GAS LINE APPROXIMATE 150' TO EXISTING GAS UTILITY METER. EXTEND FLUE TO EXISTING FLUE LOCATION.
3. CONTRACTOR TO EXTEND NEW DOMESTIC HOT WATER FROM NEW LWH TO EXISTING MAIN HOT WATER LINE.

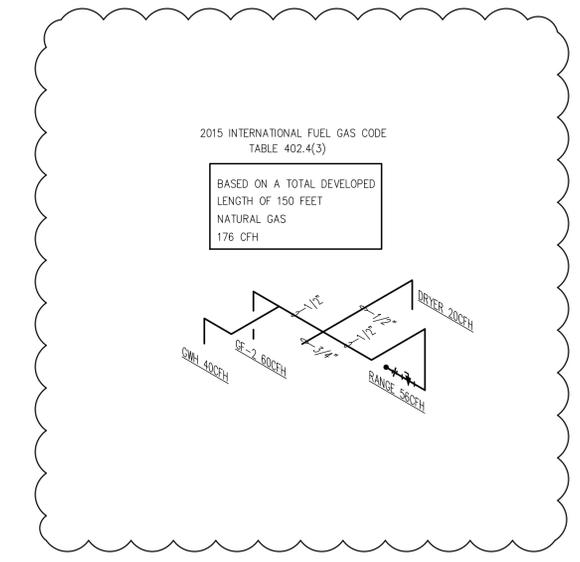

3 PLUMBING RISER - NATURAL GAS
NTS

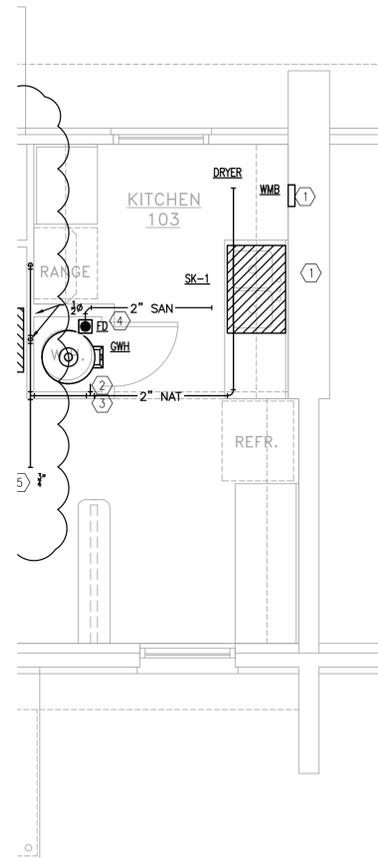

ST FLOOR - UNIT 103 & 2404

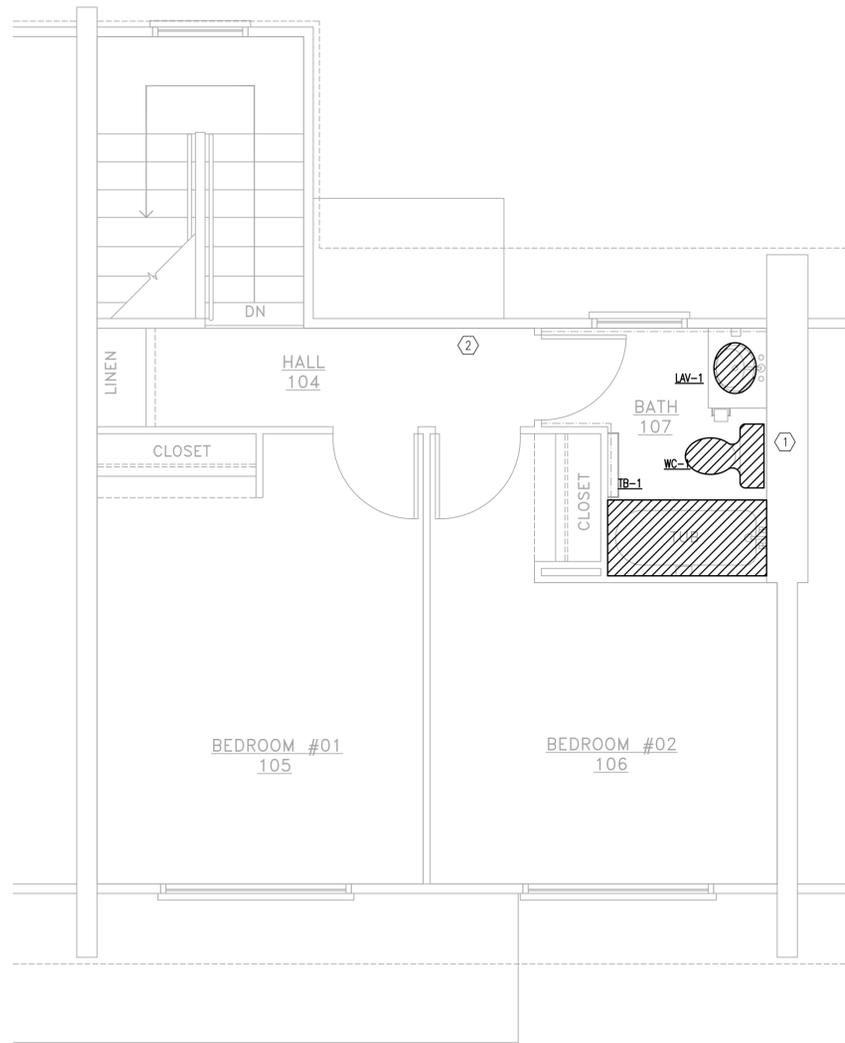

2 PLUMBING PLAN UNIT 2ND FLOOR - UNIT 103 & 2404
3/8" = 1'-0"

PLUMBING GENERAL NOTE:

1. CONTRACTOR SHALL PROVIDE LABOR AND MATERIALS TO MAKE THE NECESSARY CHANGES AND MODIFICATION TO NEW AND EXISTING PLUMBING FIXTURE/FIXTURES. REFER TO ARCHITECTURAL DRAWINGS FOR GENERAL DEMOLITION NOTES, DIMENSIONED FLOOR PLANS, MOUNTING HEIGHTS AND SCOPE OF WORK REQUIREMENTS.
2. CONTRACTOR PROVIDE NECESSARY MODIFICATION AND/OR EXTEND NEW WATER SUPPLY OR SANITARY WASTE AND VENT (CARRIER) TO NEW PLUMBING FIXTURE AND MAKE ALL FINAL CONNECTIONS.

PLUMBING RENOVATION KEYED NOTES:

1. APPROXIMATE POINT OF CONNECTION. CONTRACTOR SHALL FIELD EXISTING LOCATION OF DOMESTIC WATER LINES AND OF SANITARY.
2. EXTEND FLUE TO EXISTING FLUE LOCATION.
3. CONTRACTOR TO EXTEND NEW DOMESTIC HOT WATER FROM NEW EWH TO EXISTING MAIN HOT WATER LINE.
4. CONTRACTOR SHALL PROVIDE FLOOR DRAIN WITH TRAPGUARD AND EXTEND NEW 2" SANITARY TO EXISTING SANITARY.
5. RUN APPROXIMATELY 150' TO EXISTING LOCATION OF GAS UTILITY METER.

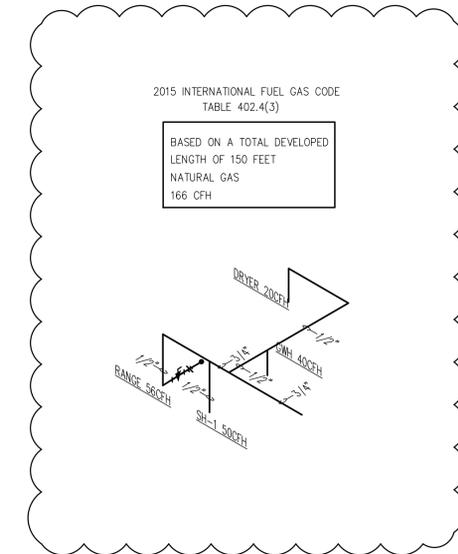

3 PLUMBING RISER - NATURAL GAS
NTS

HMB
ENGINEERING
CONSULTANTS

2902 NORTH FLORES
SAN ANTONIO, TEXAS 78212
210.393.1840 PHONE
SAN ANTONIO - RGV
TBPE FIRM REGISTRATION NO. 13361

SPRINKLE & CO.
ARCHITECTS
ALFREDO HERNANDEZ
101108
07-25-18



CASSIANO HOMES
PARTIAL REMODEL
2919 S LAREDO ST. SAN ANTONIO, TX 78207

ISSUE DATE:	11-28-2017
REVISIONS:	04-12-18 OWNER REVISIONS 07-25-18 COSA COMMENTS
	PLUMBING PLAN
SHEET:	P2.2

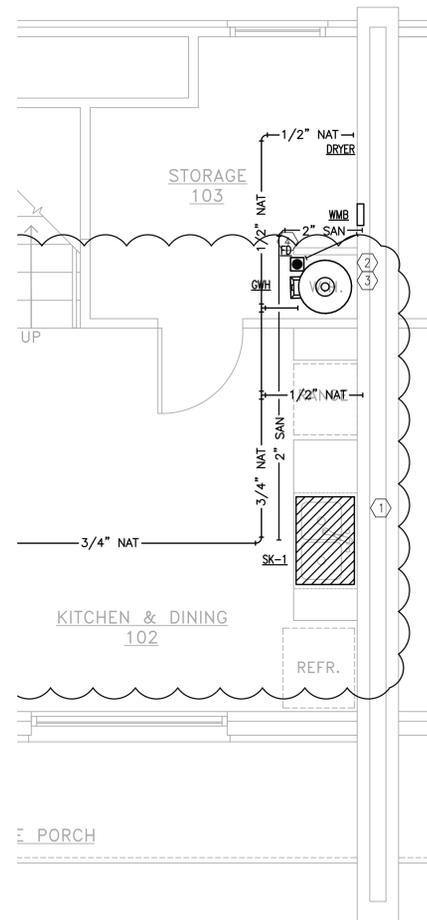

1ST FLOOR - UNIT 1523 & 3023

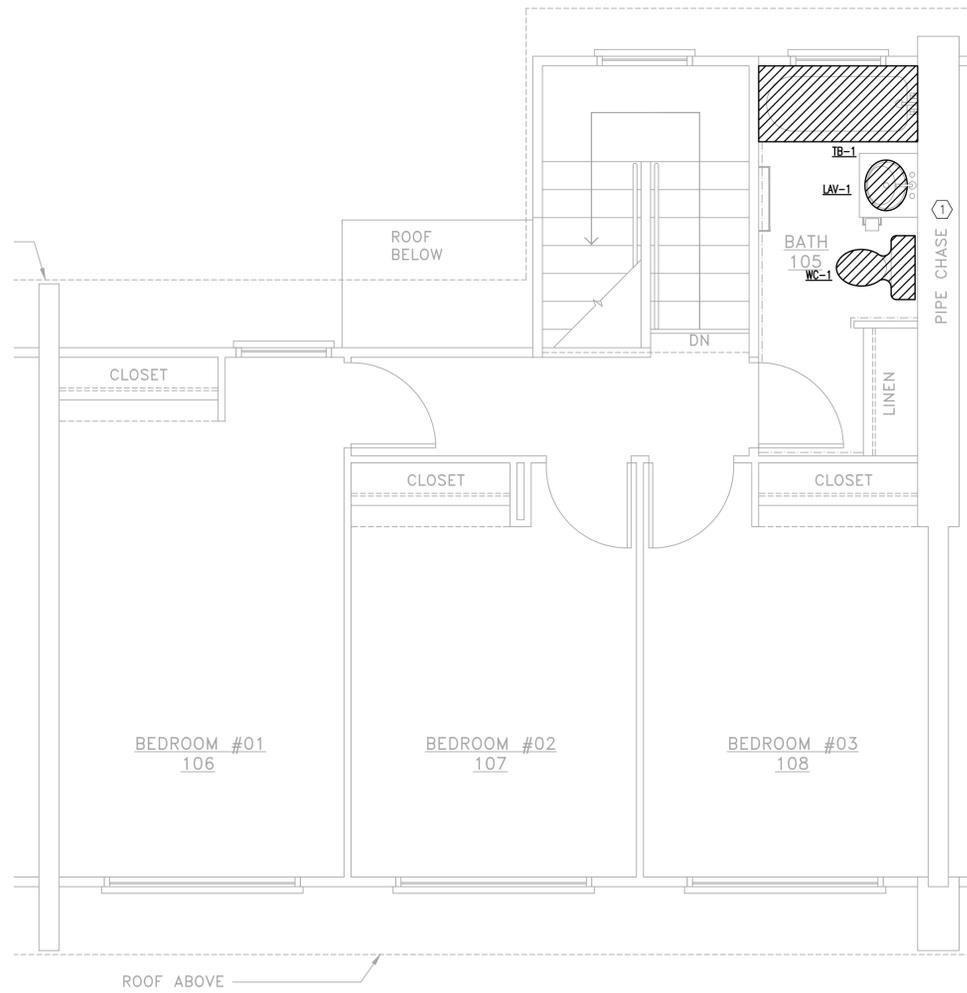

2 PLUMBING PLAN 2ND FLOOR - UNIT 1523 & 3023
3/8" = 1'-0"

PLUMBING GENERAL NOTE:

1. CONTRACTOR SHALL PROVIDE LABOR AND MATERIALS TO MAKE THE NECESSARY CHANGES AND MODIFICATION TO NEW AND EXISTING PLUMBING FIXTURE/FIXTURES. REFER TO ARCHITECTURAL DRAWINGS FOR GENERAL DEMOLITION NOTES, DIMENSIONED FLOOR PLANS, MOUNTING HEIGHTS AND SCOPE OF WORK REQUIREMENTS.
2. CONTRACTOR PROVIDE NECESSARY MODIFICATION AND/OR EXTEND NEW WATER SUPPLY OR SANITARY WASTE AND VENT (CARRIER) TO NEW PLUMBING FIXTURE AND MAKE ALL FINAL CONNECTIONS.

PLUMBING RENOVATION KEYED NOTES:

- 1 APPROXIMATE POINT OF CONNECTION. CONTRACTOR SHALL FIELD EXISTING LOCATION OF DOMESTIC WATER LINES AND OF SANITARY.
- 2 EXTEND FLUE TO EXISTING FLUE LOCATION.
- 3 CONTRACTOR TO EXTEND NEW DOMESTIC HOT WATER FROM NEW EWH TO EXISTING MAIN HOT WATER LINE.
- 4 CONTRACTOR SHALL PROVIDE FLOOR DRAIN WITH TRAPGUARD AND EXTEND NEW 2" SANITARY TO EXISTING SANITARY.
- 5 RUN APPROXIMATELY 150' TO EXISTING LOCATION OF GAS UTILITY METER.

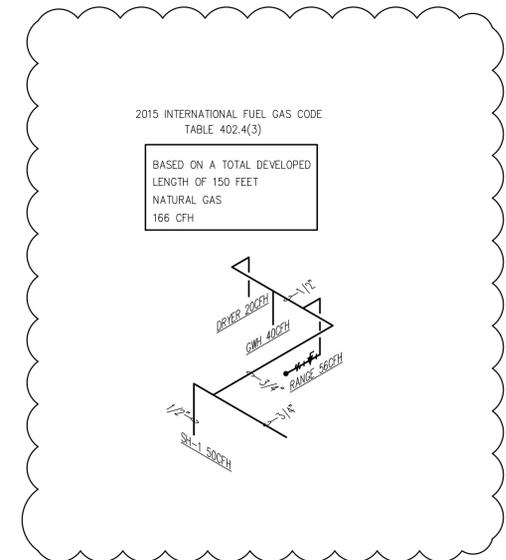

3 PLUMBING RISER - NATURAL GAS
NTS

HMB
ENGINEERING
CONSULTANTS

2902 NORTH FLORES
SAN ANTONIO, TEXAS 78212
210.393.1840 PHONE
SAN ANTONIO - RGV
TBPE FIRM REGISTRATION NO. 13361

SPRINKLE & CO.
ARCHITECTS
1100 N. LOOP WEST, SUITE 1000
SAN ANTONIO, TEXAS 78207
PHONE: 210-227-7722



07-25-18

CASSIANO HOMES
PARTIAL REMODEL
2919 S LAREDO ST. SAN ANTONIO, TX 78207

ISSUE DATE:
11-28-2017

REVISIONS:
04-12-18 OWNER REVISIONS
07-25-18 COSA COMMENTS
PLUMBING
PLAN

SHEET:
P2.3

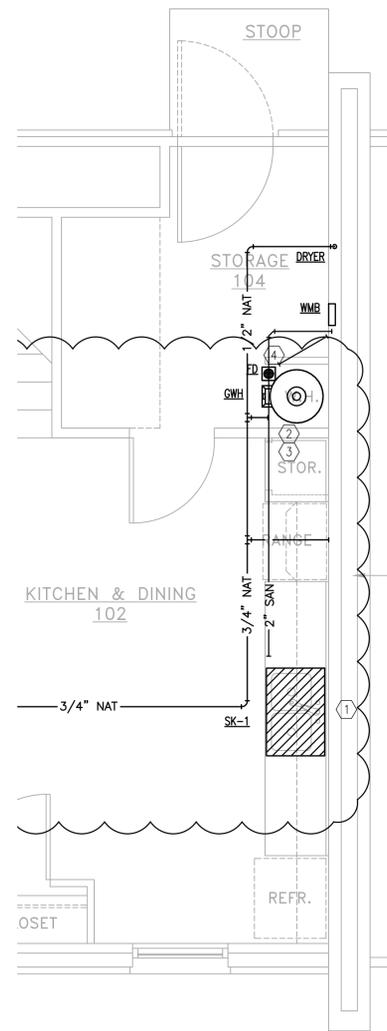

1ST FLOOR - UNIT 1501

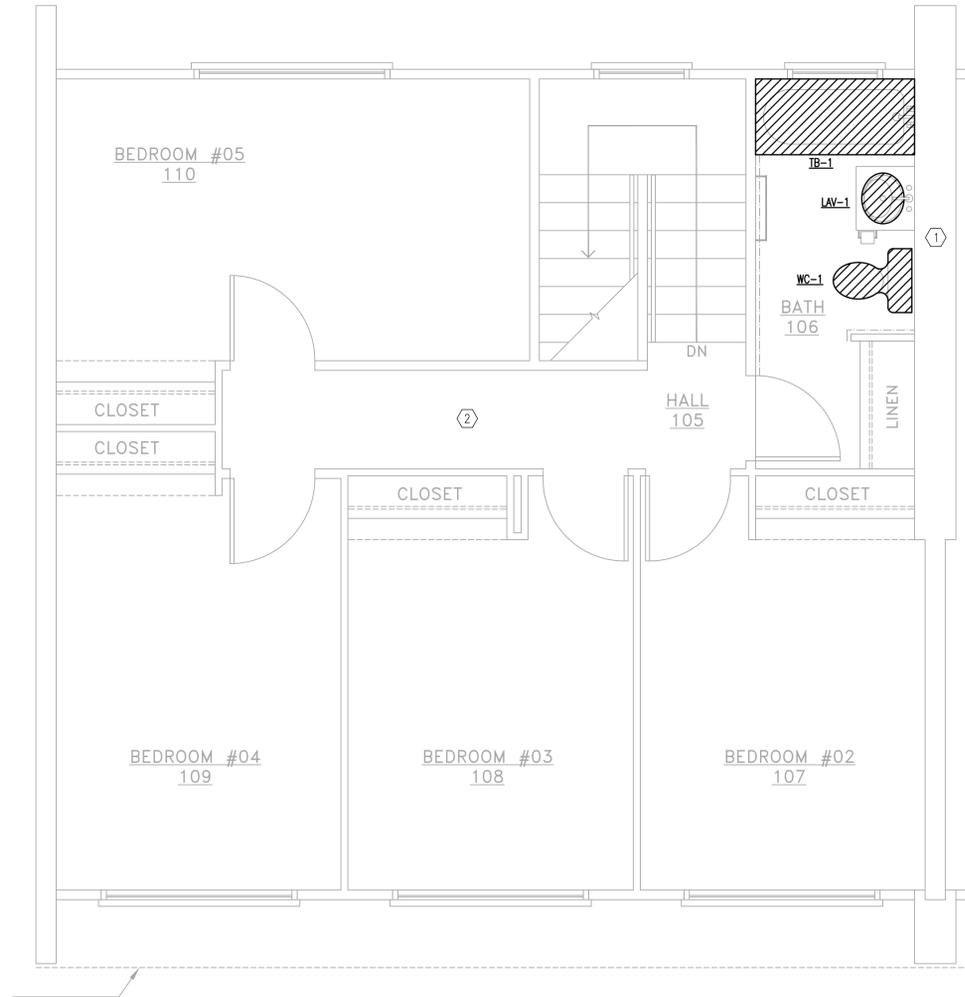

2 PLUMBING PLAN 2ND FLOOR - UNIT 1501
3/8" = 1'-0"

PLUMBING GENERAL NOTE:

1. CONTRACTOR SHALL PROVIDE LABOR AND MATERIALS TO MAKE THE NECESSARY CHANGES AND MODIFICATION TO NEW AND EXISTING PLUMBING FIXTURE/FIXTURES. REFER TO ARCHITECTURAL DRAWINGS FOR GENERAL DEMOLITION NOTES, DIMENSIONED FLOOR PLANS, MOUNTING HEIGHTS AND SCOPE OF WORK REQUIREMENTS.
2. CONTRACTOR PROVIDE NECESSARY MODIFICATION AND/OR EXTEND NEW WATER SUPPLY OR SANITARY WASTE AND VENT (CARRIER) TO NEW PLUMBING FIXTURE AND MAKE ALL FINAL CONNECTIONS.

PLUMBING RENOVATION KEYED NOTES:

1. APPROXIMATE POINT OF CONNECTION. CONTRACTOR SHALL FIELD EXISTING LOCATION OF DOMESTIC WATER LINES AND OF SANITARY.
2. EXTEND FLUE TO EXISTING FLUE LOCATION.
3. CONTRACTOR TO EXTEND NEW DOMESTIC HOT WATER FROM NEW EWH TO EXISTING MAIN HOT WATER LINE.
4. CONTRACTOR SHALL PROVIDE FLOOR DRAIN WITH TRAPGUARD AND EXTEND NEW 2" SANITARY TO EXISTING SANITARY
5. RUN APPROXIMATELY 150' TO EXISTING LOCATION OF GAS UTILITY METER.

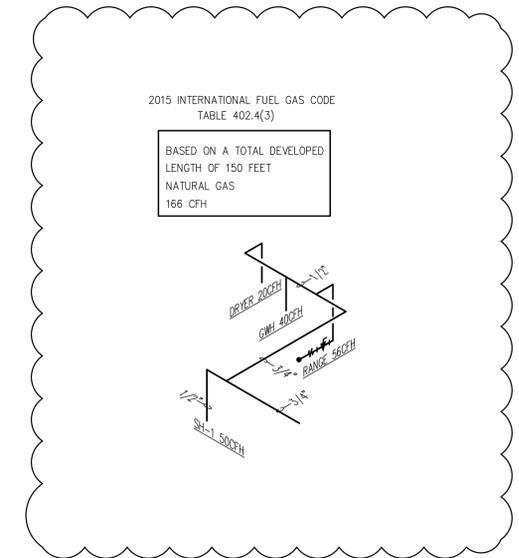

3 PLUMBING RISER - NATURAL GAS
NTS

PLUMBING FIXTURE & PIPE CONNECTION SCHEDULE									
TAG	DESCRIPTION	BASIS OF DESIGN		CONNECTION SIZE					
		MANUFACTURER	CATALOG NUMBER	CW INCHES	HW INCHES	TW INCHES	WASTE INCHES	INDIRECT WASTE INCHES	VENT INCHES
WC-1	FLOOR MOUNTED WHITE V.C. ELONGATED PRESSURE-ASSISTED 1.1 GPF - BOWL, TANK AND SEAT	AMERICAN STANDARD	CADETFLOWISE "2467.100"	1/2"	-	-	4"	-	2"
LAV-1	WALL MOUNT V.C. 22" X 17" LAVATORY SINK 4" CENTERSET HOLE. PROVIDE WALL HANGER. TWO HANDLE CHROME PLATED FAUCET 0.5GPM	AMERICAN STANDARD	"LUCERNE" 0355.012 MOEN "M-BITION" 8800F05	1/2"	1/2"	1/2"	2"	-	2"
SK-1	TOP MOUNT SS EQUAL DOUBLE BOWL 37"X22" SINK WITH GOOSENECK PULL DOWN SPRAY CHROME FAUCET ADA	ELKAY	LRAD372255 FAUCET LKHA4031	1/2"	1/2"	-	2"	-	2"
SK-2	TOP MOUNT SS EQUAL DOUBLE BOWL 29"X18" SINK WITH GOOSENECK PULL DOWN SPRAY CHROME FAUCET ADA	ELKAY	LRAD291855 FAUCET LKHA4031	1/2"	1/2"	-	2"	-	2"
GWH	40 GALLON STORAGE ASME TANK, 40,000 BTUH INPUT, 43 G RECOVERY AT 90 TEMP RISE WITH 96% THERMAL EFFICIENCY. WITH POWER VENT, TEMP./PRESS. RELIEF VALVE AND FULLY AUTOMATIC CONTROLS, SPARK IGNITION, FLAME SAFEGUARD, REGULATORS SAFETY SHUT OFF. ENTIRE ASSEMB	BRADFORD WHITE	RG24056N	-	-	-	-	-	-
TB	SINGLE-HANDLE POSI-TEMP TUB/SHOWER. LEVER STYLE HANDLE WITH TEMP. INDICATOR IN ESCUTCHEON. EP SUFFIX MODEL LIMITED TO 1.75 GPM	MOEN	T2663EP + 2520	1/2"	1/2"	-	2"	-	2"

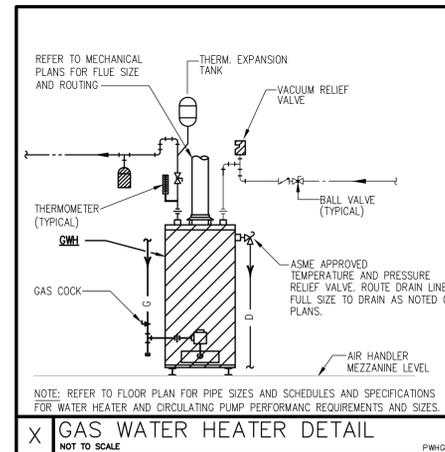

HMB
ENGINEERING
CONSULTANTS

2902 NORTH FLORES
SAN ANTONIO, TEXAS 78212
210.393.1840 PHONE
SAN ANTONIO - RGV
TBPE FIRM REGISTRATION NO. 13361

SPRINKLE & CO.
ARCHITECTS
1100 N. LOOP WEST, SUITE 1000
SAN ANTONIO, TEXAS 78207
TEL: 210-227-7722



04-12-18

CASSIANO HOMES
PARTIAL REMODEL
2919 S LAREDO ST. SAN ANTONIO, TX 78207

ISSUE DATE:
11-28-2017

REVISIONS:
04-12-18 OWNER REVISIONS
PLUMBING
SCHEDULES &
DETAILS

SHEET:
P3.0

Project: SAHA

Location:

Product Type: TIMER SWITCH T-1

Contact/Phone:

Model #: FF30MC

FF Series Commercial Series

The FF Series Commercial Auto-Off Timers are designed to replace any standard wall switch - single or multi-gang. This series of energy-efficient mechanical timers do not require electricity to operate. In addition, they automatically limit the ON times for fans, lighting, motors, heaters, and other energy consuming loads.

Features

- Hold feature enables the user to override the automatic shut-off function
- Rugged time dial plate easily withstands the abuse encountered in commercial environments
- Commercial “brushed metal” (plastic construction) look meets NEC requirements
- Time saving up front terminal connection with teeter-type terminals
- Press-on knob design ensures quick and easy installation
- CFL compatible

Not for use with sunlamps, saunas, or loads that could cause personal injury if timed incorrectly.

Ratings

Resistive: 20 Amp, 125 VAC, 50/60 Hz
 10 Amp, 250 VAC, 50/60 Hz
 10 Amp, 277 VAC, 50/60 Hz

Tungsten: 7 Amp, 125 VAC

Motor: 1 HP, 120 VAC, 50/60 Hz
 2 HP, 240 VAC, 50/60 Hz

Dimensions: 2.79" H x 1.6" W x 1.19" D

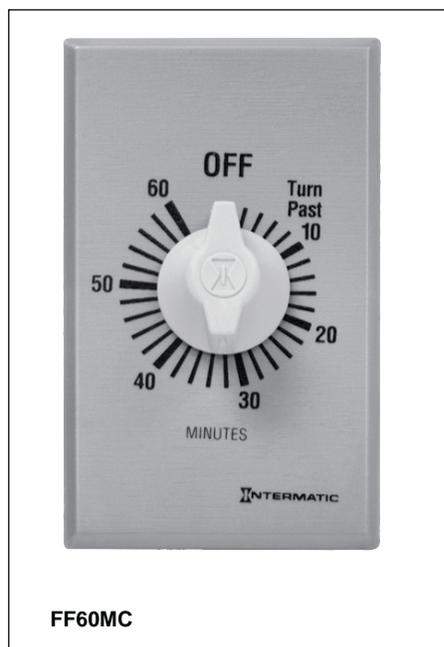

Model Number	Time Cycle	Switch	Hold	Color
FF5M	5 Minutes	SPST	No	Brushed Metal Finish
FF5MH	5 Minutes	SPST	Yes	Brushed Metal Finish
FF15MC	15 Minutes	SPST	No	Brushed Metal Finish
FF15MH	15 Minutes	SPST	Yes	Brushed Metal Finish
FF30MC	30 Minutes	SPST	No	Brushed Metal Finish
FF30MH	30 Minutes	SPST	Yes	Brushed Metal Finish
FF60MC	60 Minutes	SPST	No	Brushed Metal Finish
FF60MHC	60 Minutes	SPST	Yes	Brushed Metal Finish
FF2H	2 Hours	SPST	No	Brushed Metal Finish
FF4H	4 Hours	SPST	No	Brushed Metal Finish
FF6H	6 Hours	SPST	No	Brushed Metal Finish
FF6HH	6 Hours	SPST	Yes	Brushed Metal Finish
FF12HC	12 Hours	SPST	No	Brushed Metal Finish
FF12HHC	12 Hours	SPST	Yes	Brushed Metal Finish
FF315M	15 Minutes	SPDT	No	Brushed Metal Finish
FF330M	30 Minutes	SPDT	No	Brushed Metal Finish
FF360M	60 Minutes	SPDT	No	Brushed Metal Finish
FF32H	2 Hours	SPDT	No	Brushed Metal Finish
FF32HH	2 Hours	SPDT	Yes	Brushed Metal Finish
FF34H	4 Hours	SPDT	No	Brushed Metal Finish
FF34HH	4 Hours	SPDT	Yes	Brushed Metal Finish
FF36H	6 Hours	SPDT	No	Brushed Metal Finish
FF312H	12 Hours	SPDT	No	Brushed Metal Finish
FF312HH	12 Hours	SPDT	Yes	Brushed Metal Finish
FF415M	15 Minutes	DPST	No	Brushed Metal Finish
FF430M	30 Minutes	DPST	No	Brushed Metal Finish
FF460M	60 Minutes	DPST	No	Brushed Metal Finish
FF46H	6 Hours	DPST	No	Brushed Metal Finish
FF412H	12 Hours	DPST	No	Brushed Metal Finish

Specification

The timer shall be of the appropriate dimensions and design to provide for direct replacement of a standard wall switch in a single gang 2 1/2" deep junction box. The timer shall include a spiral time scale to provide easy selection of a desired time setting. Molded white knob and brushed metal finish wall plate shall be a press-on type requiring no screw or other hardware to secure. The polymeric time dial shall replace a standard switch plate without modifications. The timer shall have a UL listed rating of:

- 1 HP at 125 VAC, 50/60 Hz
- 2 HP at 250 VAC, 50/60 Hz
- 20 Amp, 120 VAC, 50/60 Hz
- 10 Amp, 250 VAC, 50/60 Hz
- 10 Amp, 277 VAC, 50/60 Hz
- 7 Amp, 125 VAC, Tungsten

The timer field wiring connections shall be secured by means of a teeter-type terminal screw to provide secure connections for appropriate wire sizes. The timer shall be _____ (SPST)(DPST)(SPDT). The timer _____ (Shall) (Shall Not) have a Hold feature and shall have a time cycle of _____ (See Time Cycles Listed). The timer shall be Intermatic model _____ (See Model Numbers Listed).

WF-1

For Kitchen

Perlator® Faucet Aerator - 1.5 gpm max Flow Restricted Regular Size



- Features and Benefits**
- ▶ Watercolours® design: Color coding to identify flow rate and stream pattern.
 - ▶ Patented construction provides a splash-free stream, well aerated and soft to the touch.
 - ▶ Integrated anti-liming Honeycomb replaces conventional wire mesh screens prone to lime build up.
 - ▶ Anti-clogging dome screen filters sediment and particles.
 - ▶ Also compatible with regular and vandal proof M22 and M24 metric housings.
 - ▶ Available housing finishes: unplated, chrome and PVD.
 - ▶ Laser marked housings: custom logo and/or statutory marks.

Certifications
ANSI/NSF 61
ASME A112.18.1M and CSA B125
Meets **CALGreen** requirements
WaterSense



Options Available

Part #	Designation
40.2010.000	Insert only
40.2010.613	Regular male 15/16"-27
40.2010.623	Regular female 55/64"-27
40.2010.673	Regular dual thread 15/16"-27 / 55/64"-27
40.2010.723	Vandal proof regular male 15/16"-27
40.2010.733	Vandal proof regular female 55/64"-27
40.2010.603	Vandal proof dual thread
BX.399C.1	Regular vandal key

*Other combinations also available
- WSA applies to insert only

Color Code

Dome: Green	Diffuser: Green	Basket: Dark Gray
-------------	-----------------	-------------------

Flow Rate Curve

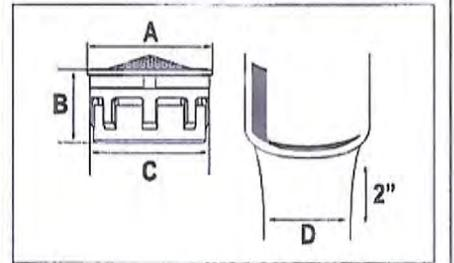
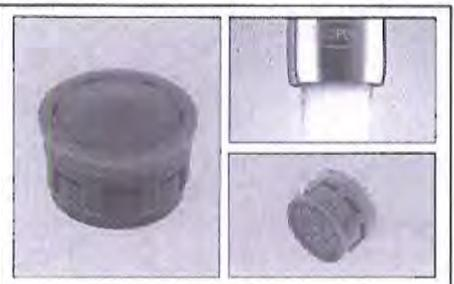
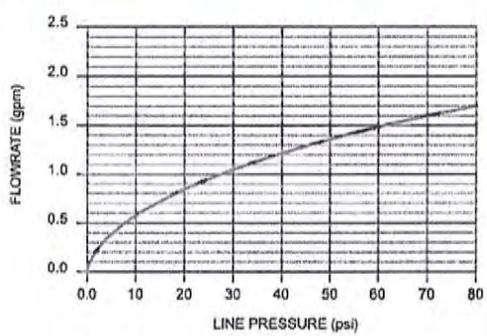

Dimensions

No.	mm	In.
A	20.88	.822
B	12.00	.472
C	19.97	.786
D	≈ 13	≈ 1/2



Technical Data

Materials: Body Acetal
Washer EPDM
Wetted surface area: 3857.85 mm²

Continuous		Short-term (5 minutes max.)	
max. 50 °C	max. 120 °F	max. 70 °C	max. 160 °F
90 psi max.	6 bar max.	125 psi max.	8.5 bar max.

NEOPERL®, Inc., Waterbury, CT • Tel: 203-756-8891 • Fax: 203-755-5717 • www.neoperl.com

TFA-4

January 2015 - Information subject to change without notice

WF-3

For Bathrooms

Perlator® Faucet Aerator - 1.0 gpm Flow Restricted Regular Size



flow, stop and go®

- Features and Benefits**
- ▶ Watercolours® design: Color coding to identify flow rate and stream pattern.
 - ▶ Patented construction provides a splash-free stream, well aerated and soft to the touch.
 - ▶ Integrated anti-liming Honeycomb replaces conventional wire mesh screens prone to lime build up.
 - ▶ Anti-clogging dome screen filters sediment and particles.
 - ▶ Also compatible with regular and vandal proof M22 and M24 metric housings.
 - ▶ Available housing finishes: unplated, chrome and PVD.
 - ▶ Laser marked housings: custom logo and/or statutory marks.

Certifications
ANSI/NSF 61
ASME A112.18.1M and CSA B125
Meets **CALGreen** requirements

Options Available

Part #	Designation
40.3031.000	Insert only
40.3031.613	Regular male 15/16" -27
40.3031.623	Regular female 55/64" -27
40.3031.673	Regular dual thread 15/16" -27 / 55/64" -27
40.3031.723	Vandal proof regular male 15/16" -27
40.3031.733	Vandal proof regular female 55/64" -27
40.3031.603	Vandal proof dual thread
BX.399C.1	Regular vandal key

*Other combinations also available
- WSA applies to insert only

Color Code

Dome: Ivory	Diffuser: White	Basket: Dark Gray
-------------	-----------------	-------------------

Flow Rate Curve

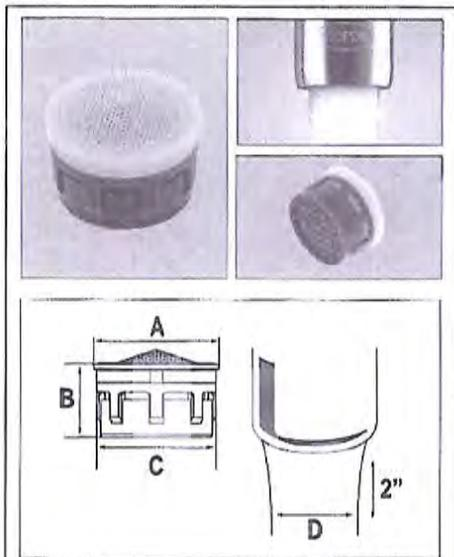
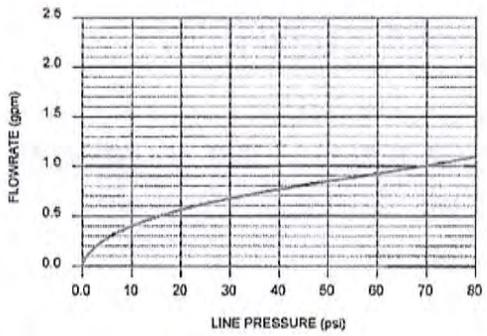

Dimensions

No.	mm	In.
A	20.88	.822
B	12.00	.472
C	19.97	.786
D	≈ 13	≈ 1/2



Technical Data

Materials: Body Acetal
Washer EPDM
Wetted surface area: 3108.17 mm²

Continuous		Short-term (5 minutes max.)	
max. 50 °C	max. 120 °F	max. 70 °C	max. 160 °F
90 psi max.	6 bar max.	125 psi max.	8.5 bar max.

NEOPERL®, Inc., Waterbury, CT • Tel: 203-756-8891 • Fax: 203-755-5717 • www.neoperl.com

SPECIFICATIONS

TOPANGA™ 3 1/2" SHOWERHEAD

Model

D460041

Description

- Pressure Manifold™ & Air Injection Technology
- Brass ball joint with polymer shell
- Optimizes water intensity even at low pressures
- With 40 easy clean jets
- Maximum flow rate 1.5 gpm @ 80 psi
- Use 40% less water than a standard showerhead flowing at 2.5 gpm

Standards



- UPC/cUPC
- Energy policy act of 1992

Warranty

Danze products are covered by a manufacturer's limited "lifetime" warranty for manufacturing defects.

Flow Rate

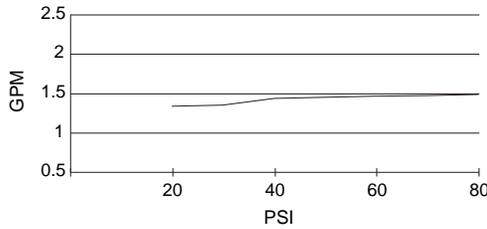

Finishes Available

- Chrome
- Other: Refer to Price List for additional finish

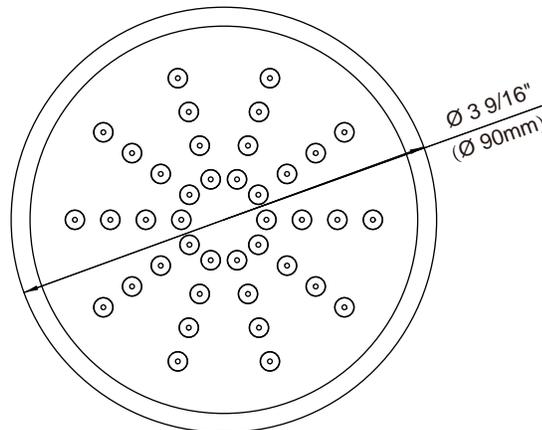
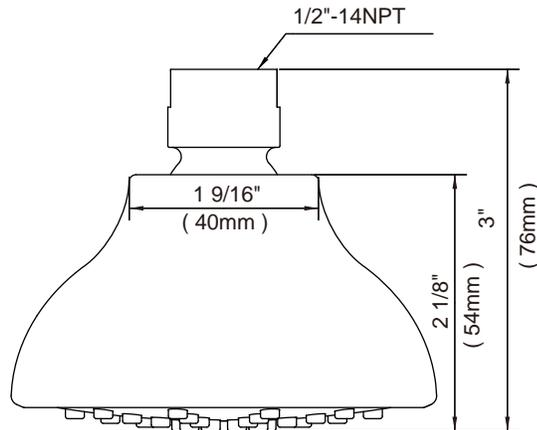

Submittal Information:

Job Name: _____

Location: _____

Contractor: _____

Contact #: _____

Schedule Of Materials-Cassiano Homes						
	Area /Location	Vendor	Pattern Name/Number	Color	Finish/Size	Miscellaneous / Notes
Door Hardware						
1	Entry/Closet/Screen door	Kwik set	720A 26D	Chrome	Satin	Passage Knob
2	Bathroom	Kwik set	730A 26D	Chrome	Satin	Privacy Knob
3	Entry doors	Kwik set	663 26D	Chrome	Satin	Single sided Deadbolt
3	Entry/Screen doors	Kwik set	780 26D SMT	Chrome	Satin	Deadbolt
4	All doors interior &Exterior Exlude- metal screen doors		Door Hindges	Chrome	Satin	General note all door hardware will match in color and apperance
Window treatments						
	All Windows	Bali	1"Vinyl Mini Blind	White	N/A	White Vinyl Mini Blind Lead free - PVC headrail and bottomrail -matching valance and hardware - custom sized (Inside Mount)Deadbolt

Electrical fixtures will be provided and installed by Contractor after being approved by SAHA

BATH



14 Bath Channel Fixture White with Convenience Outlet

Two-Light Bath Channel Wall Fixture - 14 Length - Grounded Convenience Outlet - White Base - Use 60W Max Medium Base Bulbs (Not Included) - Use 316800 Replacement

KITCHEN

Lithonia Lighting



4' Two-Light 32 Watt T8 Fluorescent Wrap Fixture With Nickel Ends

Lithonia Lighting® 4' Two-Light T8 Fluorescent Wrap Fixture - 120 Volt Residential Instant Start Electronic Ballast - Brushed Nickel End Pieces - White Enameled Steel Base - Clear Ribbed Acrylic Diffuser - Use 321688 32W T8 Bulbs (Not Included)

LIVING/BED



2 Light Flush Mount Fixture White Opal Glass 12

12 Square Two-Light Ceiling Fixture - White - Use 60W Max Medium Base Bulbs (Not Included) - Use 318550 Replacement Glass

Electrical fixtures will be provided and installed by Contractor after being approved by SAHA

HALL



2 Light Flush Mount Fixture Brushed Nickel White Glass 8

8 Mushroom Ceiling Fixture - Brushed Nickel - White Glass - 8 Fitter - Use Two 60W Max Medium Base Bulbs (Not Included)

Exterior Fixtures.



Outdoor Fluorescent Wall Fixture, 7 Watt, Clear Prismatic Acrylic Lens

7 Watt Fluorescent Wall Fixture - 120 Volt - White Aluminum Base - Clear Prismatic Acrylic Diffuser - 7-1/2H x 5-1/4W x 4D - One 7W Warm White PL Bulb Included - Use 316450 Replacement.

Electrical fixtures will be provided and installed by Contractor after being approved by SAHA

BATH (Broan MDL# 157)



Radiant Ceiling Heater

Heater shall be Broan Model 157. Housing and grille to be aluminum. Unit shall mount to a standard ceiling electrical box and extend no more than 2¾" from ceiling. Heater to deliver 1250 Watts of radiant heat from an enclosed metal-sheathed element. Heater to have automatic overheat protection. Fan motor to be permanently lubricated. Heater shall be U.L. Listed.

Installed in required locations as per Code



Combination Smoke and Carbon Monoxide Alarm

The combination smoke and carbon monoxide alarm shall be Kidde Unit Number KN-COPE-I (part number 900-0213) or approved equal. It shall be powered by 120VAC, 60Hz source with a 9V battery backup. The temperature operating range shall be between 40°F and 100°F (4°C and 38°C) and the humidity operating range shall be 5% - 85% relative humidity.

Electrical fixtures will be provided and installed by Contractor after being approved by SAHA

ENERGY PERFORMANCE BULBS (required use)

19 W	Replaces	75 W
23 W		100 W
26 W		100 W
30 W		2x60W

STANDARD SPIRAL LAMP
Self Ballasted CFL

STANDARD SPIRAL LAMPS

- EP638 - 19 Watt - 27K
- EP640 - 19 Watt - 41K
- EP642 - 23 Watt - 27K
- EP644 - 23 Watt - 41K
- EP646 - 26 Watt - 27K **120V**
- EP648 - 26 Watt - 41K
- EP650 - 30 Watt - 27K
- EP652 - 30 Watt - 41K



High Power Factor
High Luminous Efficacy
Color Rendering Index: 84
10,000 Hours

PART #	LAMP WATTS	BASE	LAMP CODE	COLOR	APPROX LUMENS	MOL	AVERAGE RATED HOURS	INNER PK/ MASTER CTN
EP638	19	STD	20TWIST/27	27K	1200	5.8"	10,000	1/50
EP640	19	STD	20TWIST/41	41K	1200	5.8"	10,000	1/50
EP642	23	STD	23TWIST/27	27K	1600	6.1"	10,000	1/50
EP644	23	STD	23TWIST/41	41K	1600	6.1"	10,000	1/50
EP646	26	STD	26TWIST/27	27K	1800	6.2"	10,000	1/50
EP648	26	STD	26TWIST/41	41K	1800	6.2"	10,000	1/50
EP650	30	STD	30TWIST/27	27K	2000	6.5"	10,000	1/50
EP652	30	STD	30TWIST/41	41K	2000	6.5"	10,000	1/50

MINI SPIRAL LAMP



Self Ballasted CFL

High Power Factor
High Luminous Efficacy
Color Rendering Index: 84
10,000 Hours

13 W	Replaces	60 W
15 W		75 W



MINI SPIRAL LAMPS

- EP630 - 13 Watt - 27K **120V**
- EP632 - 13 Watt - 41K
- EP634 - 15 Watt - 27K
- EP636 - 15 Watt - 41K



Smaller Size Fits MORE Applications

PART #	LAMP WATTS	BASE	LAMP CODE	COLOR	APPROX LUMENS	MOL	AVERAGE RATED HOURS	INNER PK/ MASTER CTN
EP630	13	STD	13MINITWIST/27	27K	900	4.4"	10,000	1/100
EP632	13	STD	13MINITWIST/41	41K	900	4.4"	10,000	1/100
EP634	14	STD	15MINITWIST/27	27K	900	5.4"	10,000	1/100
EP636	14	STD	15MINITWIST/41	41K	900	5.4"	10,000	1/100

ATTACHMENT B
HUD Forms and
Conflict of Interest Questionnaire
Form 1295 Certificate of Interested Parties

*(Form 1295 is to be completed online by the **Selected Respondent** and submitted to the Texas Ethics Commission pursuant to Government Code 2252.908 and a copy returned to SAHA with the Certification prior to contract execution. A copy of the 1295 Form is included herein for information purposes only).*

**U.S. Department of Housing and
Urban Development**
Office of Public and Indian Housing

**Instructions to Bidders for Contracts
Public and Indian Housing Programs**

Instructions to Bidders for Contracts

Public and Indian Housing Programs

Table of Contents

Clause	Page
1. Bid Preparation and Submission	1
2. Explanations and Interpretations to Prospective Bidders	1
3. Amendments to Invitations for Bids	1
4. Responsibility of Prospective Contractor	1
5. Late Submissions, Modifications, and Withdrawal of Bids	1
6. Bid Opening	2
7. Service of Protest	2
8. Contract Award	2
9. Bid Guarantee	3
10. Assurance of Completion	3
11. Preconstruction Conference	3
12. Indian Preference Requirements	3

1. Bid Preparation and Submission

(a) Bidders are expected to examine the specifications, drawings, all instructions, and, if applicable, the construction site (see also the contract clause entitled **Site Investigation and Conditions Affecting the Work** of the *General Conditions of the Contract for Construction*). Failure to do so will be at the bidders' risk.

(b) All bids must be submitted on the forms provided by the Public Housing Agency/Indian Housing Authority (PHA/IHA). Bidders shall furnish all the information required by the solicitation. Bids must be signed and the bidder's name typed or printed on the bid sheet and each continuation sheet which requires the entry of information by the bidder. Erasures or other changes must be initialed by the person signing the bid. Bids signed by an agent shall be accompanied by evidence of that agent's authority. (Bidders should retain a copy of their bid for their records.)

(c) Bidders must submit as part of their bid a completed form HUD-5369-A, "Representations, Certifications, and Other Statements of Bidders."

(d) All bid documents shall be sealed in an envelope which shall be clearly marked with the words "Bid Documents," the Invitation for Bids (IFB) number, any project or other identifying number, the bidder's name, and the date and time for receipt of bids.

(e) If this solicitation requires bidding on all items, failure to do so will disqualify the bid. If bidding on all items is not required, bidders should insert the words "No Bid" in the space provided for any item on which no price is submitted.

(f) Unless expressly authorized elsewhere in this solicitation, alternate bids will not be considered.

(g) Unless expressly authorized elsewhere in this solicitation, bids submitted by telegraph or facsimile (fax) machines will not be considered.

(h) If the proposed contract is for a Mutual Help project (as described in 24 CFR Part 905, Subpart E) that involves Mutual Help contributions of work, material, or equipment, supplemental information regarding the bid advertisement is provided as an attachment to this solicitation.

2. Explanations and Interpretations to Prospective Bidders

(a) Any prospective bidder desiring an explanation or interpretation of the solicitation, specifications, drawings, etc., must request it at least 7 days before the scheduled time for bid opening. Requests may be oral or written. Oral requests must be confirmed in writing. The only oral clarifications that will be provided will be those clearly related to solicitation procedures, i.e., not substantive technical information. No other oral explanation or interpretation will be provided. Any information given a prospective bidder concerning this solicitation will be furnished promptly to all other prospective bidders as a written amendment to the solicitation, if that information is necessary in submitting bids, or if the lack of it would be prejudicial to other prospective bidders.

(b) Any information obtained by, or provided to, a bidder other than by formal amendment to the solicitation shall not constitute a change to the solicitation.

3. Amendments to Invitations for Bids

(a) If this solicitation is amended, then all terms and conditions which are not modified remain unchanged.

(b) Bidders shall acknowledge receipt of any amendment to this solicitation (1) by signing and returning the amendment, (2) by identifying the amendment number and date on the bid form, or (3) by letter, telegram, or facsimile, if those methods are authorized in the solicitation. The PHA/IHA must receive acknowledgement by the time and at the place specified for receipt of bids. Bids which fail to acknowledge the bidder's receipt of any amendment will result in the rejection of the bid if the amendment(s) contained information which substantively changed the PHA's/IHA's requirements.

(c) Amendments will be on file in the offices of the PHA/IHA and the Architect at least 7 days before bid opening.

4. Responsibility of Prospective Contractor

(a) The PHA/IHA will award contracts only to responsible prospective contractors who have the ability to perform successfully under the terms and conditions of the proposed contract. In determining the responsibility of a bidder, the PHA/IHA will consider such matters as the bidder's:

- (1) Integrity;
- (2) Compliance with public policy;
- (3) Record of past performance; and
- (4) Financial and technical resources (including construction and technical equipment).

(b) Before a bid is considered for award, the bidder may be requested by the PHA/IHA to submit a statement or other documentation regarding any of the items in paragraph (a) above. Failure by the bidder to provide such additional information shall render the bidder nonresponsible and ineligible for award.

5. Late Submissions, Modifications, and Withdrawal of Bids

(a) Any bid received at the place designated in the solicitation after the exact time specified for receipt will not be considered unless it is received before award is made and it:

(1) Was sent by registered or certified mail not later than the fifth calendar day before the date specified for receipt of offers (e.g., an offer submitted in response to a solicitation requiring receipt of offers by the 20th of the month must have been mailed by the 15th);

(2) Was sent by mail, or if authorized by the solicitation, was sent by telegram or via facsimile, and it is determined by the PHA/IHA that the late receipt was due solely to mishandling by the PHA/IHA after receipt at the PHA/IHA; or

(3) Was sent by U.S. Postal Service Express Mail Next Day Service - Post Office to Addressee, not later than 5:00 p.m. at the place of mailing two working days prior to the date specified for receipt of proposals. The term "working days" excludes weekends and observed holidays.

(b) Any modification or withdrawal of a bid is subject to the same conditions as in paragraph (a) of this provision.

(c) The only acceptable evidence to establish the date of mailing of a late bid, modification, or withdrawal sent either by registered or certified mail is the U.S. or Canadian Postal Service postmark both on the envelope or wrapper and on the original receipt from the U.S. or Canadian Postal Service. Both postmarks must show a legible date or the bid, modification, or withdrawal shall be processed as if mailed late. "Postmark" means a printed, stamped, or otherwise placed impression (exclusive of a postage meter machine impression) that is readily identifiable without further action as having been supplied and affixed by employees of the U.S. or Canadian Postal Service on the date of mailing. Therefore, bidders should request the postal clerk to place a hand cancellation bull's-eye postmark on both the receipt and the envelope or wrapper.

(d) The only acceptable evidence to establish the time of receipt at the PHA/IHA is the time/date stamp of PHA/IHA on the proposal wrapper or other documentary evidence of receipt maintained by the PHA/IHA.

(e) The only acceptable evidence to establish the date of mailing of a late bid, modification, or withdrawal sent by Express Mail Next Day Service-Post Office to Addressee is the date entered by the post office receiving clerk on the "Express Mail Next Day Service-Post Office to Addressee" label and the postmark on both the envelope or wrapper and on the original receipt from the U.S. Postal Service. "Postmark" has the same meaning as defined in paragraph (c) of this provision, excluding postmarks of the Canadian Postal Service. Therefore, bidders should request the postal clerk to place a legible hand cancellation bull's eye postmark on both the receipt and Failure by a bidder to acknowledge receipt of the envelope or wrapper.

(f) Notwithstanding paragraph (a) of this provision, a late modification of an otherwise successful bid that makes its terms more favorable to the PHA/IHA will be considered at any time it is received and may be accepted.

(g) Bids may be withdrawn by written notice, or if authorized by this solicitation, by telegram (including mailgram) or facsimile machine transmission received at any time before the exact time set for opening of bids; provided that written confirmation of telegraphic or facsimile withdrawals over the signature of the bidder is mailed and postmarked prior to the specified bid opening time. A bid may be withdrawn in person by a bidder or its authorized representative if, before the exact time set for opening of bids, the identity of the person requesting withdrawal is established and the person signs a receipt for the bid.

6. Bid Opening

All bids received by the date and time of receipt specified in the solicitation will be publicly opened and read. The time and place of opening will be as specified in the solicitation. Bidders and other interested persons may be present.

7. Service of Protest

(a) Definitions. As used in this provision:

"Interested party" means an actual or prospective bidder whose direct economic interest would be affected by the award of the contract.

"Protest" means a written objection by an interested party to this solicitation or to a proposed or actual award of a contract pursuant to this solicitation.

(b) Protests shall be served on the Contracting Officer by obtaining written and dated acknowledgement from —

Director Of Procurement
San Antonio Housing Authority
818 S. Flores
San Antonio, TX 78204

[Contracting Officer designate the official or location where a protest may be served on the Contracting Officer]

(c) All protests shall be resolved in accordance with the PHA's/IHA's protest policy and procedures, copies of which are maintained at the PHA/IHA.

8. Contract Award

(a) The PHA/IHA will evaluate bids in response to this solicitation without discussions and will award a contract to the responsible bidder whose bid, conforming to the solicitation, will be most advantageous to the PHA/IHA considering only price and any price-related factors specified in the solicitation.

(b) If the apparent low bid received in response to this solicitation exceeds the PHA's/IHA's available funding for the proposed contract work, the PHA/IHA may either accept separately priced items (see 8(e) below) or use the following procedure to determine contract award. The PHA/IHA shall apply in turn to each bid (proceeding in order from the apparent low bid to the high bid) each of the separately priced bid deductible items, if any, in their priority order set forth in this solicitation. If upon the application of the first deductible item to all initial bids, a new low bid is within the PHA's/IHA's available funding, then award shall be made to that bidder. If no bid is within the available funding amount, then the PHA/IHA shall apply the second deductible item. The PHA/IHA shall continue this process until an evaluated low bid, if any, is within the PHA's/IHA's available funding. If upon the application of all deductibles, no bid is within the PHA's/IHA's available funding, or if the solicitation does not request separately priced deductibles, the PHA/IHA shall follow its written policy and procedures in making any award under this solicitation.

(c) In the case of tie low bids, award shall be made in accordance with the PHA's/IHA's written policy and procedures.

(d) The PHA/IHA may reject any and all bids, accept other than the lowest bid (e.g., the apparent low bid is unreasonably low), and waive informalities or minor irregularities in bids received, in accordance with the PHA's/IHA's written policy and procedures.

(e) Unless precluded elsewhere in the solicitation, the PHA/IHA may accept any item or combination of items bid.

(f) The PHA/IHA may reject any bid as nonresponsive if it is materially unbalanced as to the prices for the various items of work to be performed. A bid is materially unbalanced when it is based on prices significantly less than cost for some work and prices which are significantly overstated for other work.

(g) A written award shall be furnished to the successful bidder within the period for acceptance specified in the bid and shall result in a binding contract without further action by either party.

9. Bid Guarantee (applicable to construction and equipment contracts exceeding \$25,000)

All bids must be accompanied by a negotiable bid guarantee which shall not be less than five percent (5%) of the amount of the bid. The bid guarantee may be a certified check, bank draft, U.S. Government Bonds at par value, or a bid bond secured by a surety company acceptable to the U.S. Government and authorized to do business in the state where the work is to be performed. In the case where the work under the contract will be performed on an Indian reservation area, the bid guarantee may also be an irrevocable Letter of Credit (see provision 10, Assurance of Completion, below). Certified checks and bank drafts must be made payable to the order of the PHA/IHA. The bid guarantee shall insure the execution of the contract and the furnishing of a method of assurance of completion by the successful bidder as required by the solicitation. Failure to submit a bid guarantee with the bid shall result in the rejection of the bid. Bid guarantees submitted by unsuccessful bidders will be returned as soon as practicable after bid opening.

10. Assurance of Completion

(a) Unless otherwise provided in State law, the successful bidder shall furnish an assurance of completion prior to the execution of any contract under this solicitation. This assurance may be [Contracting Officer check applicable items] —

(1) a performance and payment bond in a penal sum of 100 percent of the contract price; or, as may be required or permitted by State law;

(2) separate performance and payment bonds, each for 50 percent or more of the contract price;

(3) a 20 percent cash escrow;

(4) a 25 percent irrevocable letter of credit; or,

(5) an irrevocable letter of credit for 10 percent of the total contract price with a monitoring and disbursements agreement with the IHA (applicable only to contracts awarded by an IHA under the Indian Housing Program).

(b) Bonds must be obtained from guarantee or surety companies acceptable to the U.S. Government and authorized to do business in the state where the work is to be performed. Individual sureties will not be considered. U.S. Treasury Circular Number 570, published annually in the Federal Register, lists companies approved to act as sureties on bonds securing Government contracts, the maximum underwriting limits on each contract bonded, and the States in which the company is licensed to do business. Use of companies listed in this circular is mandatory. Copies of the circular may be downloaded on the U.S. Department of Treasury website <http://www.fms.treas.gov/c570/index.html>, or ordered for a minimum fee by contacting the Government Printing Office at (202) 512-2168.

(c) Each bond shall clearly state the rate of premium and the total amount of premium charged. The current power of attorney for the person who signs for the surety company must be attached to the bond. The effective date of the power of attorney shall not precede the date of the bond. The effective date of the bond shall be on or after the execution date of the contract.

(d) Failure by the successful bidder to obtain the required assurance of completion within the time specified, or within such extended period as the PHA/IHA may grant based upon reasons determined adequate by the PHA/IHA, shall render the bidder ineligible for award. The PHA/IHA may then either award the contract to the next lowest responsible bidder or solicit new bids. The PHA/IHA may retain the ineligible bidder's bid guarantee.

11. Preconstruction Conference (applicable to construction contracts)

After award of a contract under this solicitation and prior to the start of work, the successful bidder will be required to attend a preconstruction conference with representatives of the PHA/IHA and its architect/engineer, and other interested parties convened by the PHA/IHA. The conference will serve to acquaint the participants with the general plan of the construction operation and all other requirements of the contract (e.g., Equal Employment Opportunity, Labor Standards). The PHA/IHA will provide the successful bidder with the date, time, and place of the conference.

12. Indian Preference Requirements (applicable only if this solicitation is for a contract to be performed on a project for an Indian Housing Authority)

(a) HUD has determined that the contract awarded under this solicitation is subject to the requirements of section 7(b) of the Indian Self-Determination and Education Assistance Act (25 U.S.C. 450e(b)). Section 7(b) requires that any contract or subcontract entered into for the benefit of Indians shall require that, to the greatest extent feasible

(1) Preferences and opportunities for training and employment (other than core crew positions; see paragraph (h) below) in connection with the administration of such contracts or subcontracts be given to qualified "Indians." The Act defines "Indians" to mean persons who are members of an Indian tribe and defines "Indian tribe" to mean any Indian tribe, band, nation, or other organized group or community, including any Alaska Native village or regional or village corporation as defined in or established pursuant to the Alaska Native Claims Settlement Act, which is recognized as eligible for the special programs and services provided by the United States to Indians because of their status as Indians; and,

(2) Preference in the award of contracts or subcontracts in connection with the administration of contracts be given to Indian organizations and to Indian-owned economic enterprises, as defined in section 3 of the Indian Financing Act of 1974 (25 U.S.C. 1452). That Act defines "economic enterprise" to mean any Indian-owned commercial, industrial, or business activity established or organized for the purpose of profit, except that the Indian ownership must constitute not less than 51 percent of the enterprise; "Indian organization" to mean the governing body of any Indian tribe or entity established or recognized by such governing body; "Indian" to mean any person who is a member of any tribe, band, group, pueblo, or community which is recognized by the Federal Government as eligible for services from the Bureau of Indian Affairs and any "Native" as defined in the Alaska Native Claims Settlement Act; and Indian "tribe" to mean any Indian tribe, band, group, pueblo, or community including Native villages and Native groups (including

corporations organized by Kenai, Juneau, Sitka, and Kodiak) as defined in the Alaska Native Claims Settlement Act, which is recognized by the Federal Government as eligible for services from the Bureau of Indian Affairs.

(b) (1) The successful Contractor under this solicitation shall comply with the requirements of this provision in awarding all subcontracts under the contract and in providing training and employment opportunities.

(2) A finding by the IHA that the contractor, either (i) awarded a subcontract without using the procedure required by the IHA, (ii) falsely represented that subcontracts would be awarded to Indian enterprises or organizations; or, (iii) failed to comply with the contractor's employment and training preference bid statement shall be grounds for termination of the contract or for the assessment of penalties or other remedies.

(c) If specified elsewhere in this solicitation, the IHA may restrict the solicitation to qualified Indian-owned enterprises and Indian organizations. If two or more (or a greater number as specified elsewhere in the solicitation) qualified Indian-owned enterprises or organizations submit responsive bids, award shall be made to the qualified enterprise or organization with the lowest responsive bid. If fewer than the minimum required number of qualified Indian-owned enterprises or organizations submit responsive bids, the IHA shall reject all bids and readvertise the solicitation in accordance with paragraph (d) below.

(d) If the IHA prefers not to restrict the solicitation as described in paragraph (c) above, or if after having restricted a solicitation an insufficient number of qualified Indian enterprises or organizations submit bids, the IHA may advertise for bids from non-Indian as well as Indian-owned enterprises and Indian organizations. Award shall be made to the qualified Indian enterprise or organization with the lowest responsive bid if that bid is -

(1) Within the maximum HUD-approved budget amount established for the specific project or activity for which bids are being solicited; and

(2) No more than the percentage specified in 24 CFR 905.175(c) higher than the total bid price of the lowest responsive bid from any qualified bidder. If no responsive bid by a qualified Indian-owned economic enterprise or organization is within the stated range of the total bid price of the lowest responsive bid from any qualified enterprise, award shall be made to the bidder with the lowest bid.

(e) Bidders seeking to qualify for preference in contracting or subcontracting shall submit proof of Indian ownership with their bids. Proof of Indian ownership shall include but not be limited to:

(1) Certification by a tribe or other evidence that the bidder is an Indian. The IHA shall accept the certification of a tribe that an individual is a member.

(2) Evidence such as stock ownership, structure, management, control, financing and salary or profit sharing arrangements of the enterprise.

(f) (1) All bidders must submit with their bids a statement describing how they will provide Indian preference in the award of subcontracts. The specific requirements of that statement and the factors to be used by the IHA in determining the statement's adequacy are included as an attachment to this solicitation. Any bid that fails to include the required statement shall be rejected as nonresponsive. The IHA may require that comparable statements be provided by subcontractors to the successful Contractor, and may require the Contractor to reject any bid or proposal by a subcontractor that fails to include the statement.

(2) Bidders and prospective subcontractors shall submit a certification (supported by credible evidence) to the IHA in any instance where the bidder or subcontractor believes it is infeasible to provide Indian preference in subcontracting. The acceptance or rejection by the IHA of the certification shall be final. Rejection shall disqualify the bid from further consideration.

(g) All bidders must submit with their bids a statement detailing their employment and training opportunities and their plans to provide preference to Indians in implementing the contract; and the number or percentage of Indians anticipated to be employed and trained. Comparable statements from all proposed subcontractors must be submitted. The criteria to be used by the IHA in determining the statement(s)'s adequacy are included as an attachment to this solicitation. Any bid that fails to include the required statement(s), or that includes a statement that does not meet minimum standards required by the IHA shall be rejected as nonresponsive.

(h) Core crew employees. A core crew employee is an individual who is a bona fide employee of the contractor at the time the bid is submitted; or an individual who was not employed by the bidder at the time the bid was submitted, but who is regularly employed by the bidder in a supervisory or other key skilled position when work is available. Bidders shall submit with their bids a list of all core crew employees.

(i) Preference in contracting, subcontracting, employment, and training shall apply not only on-site, on the reservation, or within the IHA's jurisdiction, but also to contracts with firms that operate outside these areas (e.g., employment in modular or manufactured housing construction facilities).

(j) Bidders should contact the IHA to determine if any additional local preference requirements are applicable to this solicitation.

(k) The IHA [] does [] does not [Contracting Officer check applicable box] maintain lists of Indian-owned economic enterprises and Indian organizations by specialty (e.g., plumbing, electrical, foundations), which are available to bidders to assist them in meeting their responsibility to provide preference in connection with the administration of contracts and subcontracts.

General Conditions for Construction Contracts - Public Housing Programs

U.S. Department of Housing and Urban Development
Office of Public and Indian Housing
OMB Approval No. 2577-0157 (exp. 3/31/2020)

Applicability. This form is applicable to any construction/development contract greater than \$150,000.

This form includes those clauses required by OMB's common rule on grantee procurement, implemented at HUD in 2 CFR 200, and those requirements set forth in Section 3 of the Housing and Urban Development Act of 1968 and its amendment by the Housing and Community Development Act of 1992, implemented by HUD at 24 CFR Part 135. The form is required for construction contracts awarded by Public Housing Agencies (PHAs).

The form is used by Housing Authorities in solicitations to provide necessary contract clauses. If the form were not used, HAs would be unable to enforce their contracts.

Public reporting burden for this collection of information is estimated to average 1.0 hours per response, including the time for reviewing instructions, searching existing data sources, gathering and maintaining the data needed, and completing and reviewing the collection of information. Responses to the collection of information are required to obtain a benefit or to retain a benefit.

The information requested does not lend itself to confidentiality.

HUD may not conduct or sponsor, and a person is not required to respond to a collection of information unless it displays a currently valid OMB number.

Clause		Page	Clause		Page
1.	Definitions	2	Administrative Requirements		
2.	Contractor's Responsibility for Work	2	25.	Contract Period	9
3.	Architect's Duties, Responsibilities and Authority	2	26.	Order of Precedence	9
4.	Other Contracts	3	27.	Payments	9
Construction Requirements			28.	Contract Modifications	10
5.	Preconstruction Conference and Notice to Proceed	3	29.	Changes	10
6.	Construction Progress Schedule	3	30.	Suspension of Work	11
7.	Site Investigation and Conditions Affecting the Work	3	31.	Disputes	11
8.	Differing Site Conditions	4	32.	Default	11
9.	Specifications and Drawings for Construction	4	33.	Liquidated	12
10.	As-Built Drawings	5	34.	Termination of Convenience	12
11.	Material and Workmanship	5	35.	Assignment of Contract	12
12.	Permits and Codes	5	36.	Insurance	12
13.	Health, Safety, and Accident Prevention	6	37.	Subcontracts	13
14.	Temporary Buildings and Transportation Materials	6	38.	Subcontracting with Small and Minority Firms, Women's Business Enterprise, and Labor Surplus Area Firms	13
15.	Availability and Use of Utility Services	6	39.	Equal Employment Opportunity	13
16.	Protection of Existing Vegetation, Structures, Equipment, Utilities, and Improvements	6	40.	Employment, Training, and Contracting Opportunities for Low-Income Persons, Section 3 of the Housing and Urban Development Act of 1968	14
17.	Temporary Buildings and Transportation Materials	7	41.	Interest of Members of Congress	15
18.	Clean Air and Water	7	42.	Interest of Members, Officers, or Employees and Former Members, Officers, or Employees	15
19.	Energy Efficiency	7	43.	Limitations on Payments Made to Influence	15
20.	Inspection and Acceptance of Construction	7	44.	Royalties and Patents	15
21.	Use and Possession Prior to	8	45.	Examination and Retention of Contractor's Records	15
22.	Warranty of Title	8	46.	Labor Standards-Davis-Bacon and Related Acts	15
23.	Warranty of	8	47.	Non-Federal Prevailing Wage Rates	19
24.	Prohibition Against	9	48.	Procurement of Recovered	19

1. Definitions

- (a) "Architect" means the person or other entity engaged by the PHA to perform architectural, engineering, design, and other services related to the work as provided for in the contract. When a PHA uses an engineer to act in this capacity, the terms "architect" and "engineer" shall be synonymous. The Architect shall serve as a technical representative of the Contracting Officer. The Architect's authority is as set forth elsewhere in this contract.
 - (b) "Contract" means the contract entered into between the PHA and the Contractor. It includes the forms of Bid, the Bid Bond, the Performance and Payment Bond or Bonds or other assurance of completion, the Certifications, Representations, and Other Statements of Bidders (form HUD-5370), these General Conditions of the Contract for Construction (form HUD-5370), the applicable wage rate determinations from the U.S. Department of Labor, any special conditions included elsewhere in the contract, the specifications, and drawings. It includes all formal changes to any of those documents by addendum, change order, or other modification.
 - (c) "Contracting Officer" means the person delegated the authority by the PHA to enter into, administer, and/or terminate this contract and designated as such in writing to the Contractor. The term includes any successor Contracting Officer and any duly authorized representative of the Contracting Officer also designated in writing. The Contracting Officer shall be deemed the authorized agent of the PHA in all dealings with the Contractor.
 - (d) "Contractor" means the person or other entity entering into the contract with the PHA to perform all of the work required under the contract.
 - (e) "Drawings" means the drawings enumerated in the schedule of drawings contained in the Specifications and as described in the contract clause entitled Specifications and Drawings for Construction herein.
 - (f) "HUD" means the United States of America acting through the Department of Housing and Urban Development including the Secretary, or any other person designated to act on its behalf. HUD has agreed, subject to the provisions of an Annual Contributions Contract (ACC), to provide financial assistance to the PHA, which includes assistance in financing the work to be performed under this contract. As defined elsewhere in these General Conditions or the contract documents, the determination of HUD may be required to authorize changes in the work or for release of funds to the PHA for payment to the Contractor. Notwithstanding HUD's role, nothing in this contract shall be construed to create any contractual relationship between the Contractor and HUD.
 - (g) "Project" means the entire project, whether construction or rehabilitation, the work for which is provided for in whole or in part under this contract.
 - (h) "PHA" means the Public Housing Agency organized under applicable state laws which is a party to this contract.
 - (j) "Specifications" means the written description of the technical requirements for construction and includes the criteria and tests for determining whether the requirements are met.
 - (l) "Work" means materials, workmanship, and manufacture and fabrication of components.
- (a) The Contractor shall furnish all necessary labor, materials, tools, equipment, and transportation necessary for performance of the work. The Contractor shall also furnish all necessary water, heat, light, and power not made available to the Contractor by the PHA pursuant to the clause entitled Availability and Use of Utility Services herein.
 - (b) The Contractor shall perform on the site, and with its own organization, work equivalent to at least [] (12 percent unless otherwise indicated) of the total amount of work to be performed under the order. This percentage may be reduced by a supplemental agreement to this order if, during performing the work, the Contractor requests a reduction and the Contracting Officer determines that the reduction would be to the advantage of the PHA.
 - (c) At all times during performance of this contract and until the work is completed and accepted, the Contractor shall directly superintend the work or assign and have on the work site a competent superintendent who is satisfactory to the Contracting Officer and has authority to act for the Contractor.
 - (d) The Contractor shall be responsible for all damages to persons or property that occur as a result of the Contractor's fault or negligence, and shall take proper safety and health precautions to protect the work, the workers, the public, and the property of others. The Contractor shall hold and save the PHA, its officers and agents, free and harmless from liability of any nature occasioned by the Contractor's performance. The Contractor shall also be responsible for all materials delivered and work performed until completion and acceptance of the entire work, except for any completed unit of work which may have been accepted under the contract.
 - (e) The Contractor shall lay out the work from base lines and bench marks indicated on the drawings and be responsible for all lines, levels, and measurements of all work executed under the contract. The Contractor shall verify the figures before laying out the work and will be held responsible for any error resulting from its failure to do so.
 - (f) The Contractor shall confine all operations (including storage of materials) on PHA premises to areas authorized or approved by the Contracting Officer.
 - (g) The Contractor shall at all times keep the work area, including storage areas, free from accumulations of waste materials. After completing the work and before final inspection, the Contractor shall (1) remove from the premises all scaffolding, equipment, tools, and materials (including rejected materials) that are not the property of the PHA and all rubbish caused by its work; (2) leave the work area in a clean, neat, and orderly condition satisfactory to the Contracting Officer; (3) perform all specified tests; and, (4) deliver the installation in complete and operating condition.
 - (h) The Contractor's responsibility will terminate when all work has been completed, the final inspection made, and the work accepted by the Contracting Officer. The Contractor will then be released from further obligation except as required by the warranties specified elsewhere in the contract.

3. Architect's Duties, Responsibilities, and Authority

- (a) The Architect for this contract, and any successor, shall be designated in writing by the Contracting Officer.

2. Contractor's Responsibility for Work

-
- (b) The Architect shall serve as the Contracting Officer's technical representative with respect to architectural, engineering, and design matters related to the work performed under the contract. The Architect may provide direction on contract performance. Such direction shall be within the scope of the contract and may not be of a nature which: (1) institutes additional work outside the scope of the contract; (2) constitutes a change as defined in the Changes clause herein; (3) causes an increase or decrease in the cost of the contract; (4) alters the Construction Progress Schedule; or (5) changes any of the other express terms or conditions of the contract.
- (c) The Architect's duties and responsibilities may include but shall not be limited to:
- (1) Making periodic visits to the work site, and on the basis of his/her on-site inspections, issuing written reports to the PHA which shall include all observed deficiencies. The Architect shall file a copy of the report with the Contractor's designated representative at the site;
 - (2) Making modifications in drawings and technical specifications and assisting the Contracting Officer in the preparation of change orders and other contract modifications for issuance by the Contracting Officer;
 - (3) Reviewing and making recommendations with respect to - (i) the Contractor's construction progress schedules; (ii) the Contractor's shop and detailed drawings; (iii) the machinery, mechanical and other equipment and materials or other articles proposed for use by the Contractor; and, (iv) the Contractor's price breakdown and progress payment estimates; and,
 - (4) Assisting in inspections, signing Certificates of Completion, and making recommendations with respect to acceptance of work completed under the contract.

4. Other Contracts

The PHA may undertake or award other contracts for additional work at or near the site of the work under this contract. The Contractor shall fully cooperate with the other contractors and with PHA employees and shall carefully adapt scheduling and performing the work under this contract to accommodate the additional work, heeding any direction that may be provided by the Contracting Officer. The Contractor shall not commit or permit any act that will interfere with the performance of work by any other contractor or by PHA employees

Construction Requirements

5. Pre-construction Conference and Notice to Proceed

- (a) Within ten calendar days of contract execution, and prior to the commencement of work, the Contractor shall attend a preconstruction conference with representatives of the PHA, its Architect, and other interested parties convened by the PHA. The conference will serve to acquaint the participants with the general plan of the construction operation and all other requirements of the contract. The PHA will provide the Contractor with the date, time, and place of the conference.
- (b) The contractor shall begin work upon receipt of a written Notice to Proceed from the Contracting Officer or designee. The Contractor shall not begin work prior to receiving such notice.

6. Construction Progress Schedule

- (a) The Contractor shall, within five days after the work commences on the contract or another period of time determined by the Contracting Officer, prepare and submit to the Contracting Officer for approval three copies of a practicable schedule showing the order in which the Contractor proposes to perform the work, and the dates on which the Contractor contemplates starting and completing the several salient features of the work (including acquiring labor, materials, and equipment). The schedule shall be in the form of a progress chart of suitable scale to indicate appropriately the percentage of work scheduled for completion by any given date during the period. If the Contractor fails to submit a schedule within the time prescribed, the Contracting Officer may withhold approval of progress payments or take other remedies under the contract until the Contractor submits the required schedule.
- (b) The Contractor shall enter the actual progress on the chart as required by the Contracting Officer, and immediately deliver three copies of the annotated schedule to the Contracting Officer. If the Contracting Officer determines, upon the basis of inspection conducted pursuant to the clause entitled Inspection and Acceptance of Construction, herein that the Contractor is not meeting the approved schedule, the Contractor shall take steps necessary to improve its progress, including those that may be required by the Contracting Officer, without additional cost to the PHA. In this circumstance, the Contracting Officer may require the Contractor to increase the number of shifts, overtime operations, days of work, and/or the amount of construction plant, and to submit for approval any supplementary schedule or schedules in chart form as the Contracting Officer deems necessary to demonstrate how the approved rate of progress will be regained.
- (c) Failure of the Contractor to comply with the requirements of the Contracting Officer under this clause shall be grounds for a determination by the Contracting Officer that the Contractor is not prosecuting the work with sufficient diligence to ensure completion within the time specified in the Contract. Upon making this determination, the Contracting Officer may terminate the Contractor's right to proceed with the work, or any separable part of it, in accordance with the Default clause of this contract.

7. Site Investigation and Conditions Affecting the Work

- (a) The Contractor acknowledges that it has taken steps reasonably necessary to ascertain the nature and location of the work, and that it has investigated and satisfied itself as to the general and local conditions which can affect the work or its cost, including but not limited to, (1) conditions bearing upon transportation, disposal, handling, and storage of materials; (2) the availability of labor, water, electric power, and roads; (3) uncertainties of weather, river stages, tides, or similar physical conditions at the site; (4) the conformation and conditions of the ground; and (5) the character of equipment and facilities needed preliminary to and during work performance. The Contractor also acknowledges that it has satisfied itself as to the character, quality, and quantity of surface and subsurface materials or obstacles to be encountered insofar as this information is

reasonably ascertainable from an inspection of the site, including all exploratory work done by the PHA, as well as from the drawings and specifications made a part of this contract. Any failure of the Contractor to take the actions described and acknowledged in this paragraph will not relieve the Contractor from responsibility for estimating properly the difficulty and cost of successfully performing the work, or for proceeding to successfully perform the work without additional expense to the PHA.

- (b) The PHA assumes no responsibility for any conclusions or interpretations made by the Contractor based on the information made available by the PHA. Nor does the PHA assume responsibility for any understanding reached or representation made concerning conditions which can affect the work by any of its officers or agents before the execution of this contract, unless that understanding or representation is expressly stated in this contract.

8. Differing Site Conditions

- (a) The Contractor shall promptly, and before the conditions are disturbed, give a written notice to the Contracting Officer of (1) subsurface or latent physical conditions at the site which differ materially from those indicated in this contract, or (2) unknown physical conditions at the site(s), of an unusual nature, which differ materially from those ordinarily encountered and generally recognized as inhering in work of the character provided for in the contract.
- (b) The Contracting Officer shall investigate the site conditions promptly after receiving the notice. Work shall not proceed at the affected site, except at the Contractor's risk, until the Contracting Officer has provided written instructions to the Contractor. If the conditions do materially so differ and cause an increase or decrease in the Contractor's cost of, or the time required for, performing any part of the work under this contract, whether or not changed as a result of the conditions, the Contractor shall file a claim in writing to the PHA within ten days after receipt of such instructions and, in any event, before proceeding with the work. An equitable adjustment in the contract price, the delivery schedule, or both shall be made under this clause and the contract modified in writing accordingly.
- (c) No request by the Contractor for an equitable adjustment to the contract under this clause shall be allowed, unless the Contractor has given the written notice required; provided, that the time prescribed in (a) above for giving written notice may be extended by the Contracting Officer.
- (d) No request by the Contractor for an equitable adjustment to the contract for differing site conditions shall be allowed if made after final payment under this contract.

9. Specifications and Drawings for Construction

- (a) The Contractor shall keep on the work site a copy of the drawings and specifications and shall at all times give the Contracting Officer access thereto. Anything mentioned in the specifications and not shown on the drawings, or shown on the drawings and not mentioned in the specifications, shall be of like effect as if shown or mentioned in both. In case of difference between drawings and specifications, the specifications shall govern. In case of discrepancy in the figures, in the drawings, or in the specifications, the matter shall be

promptly submitted to the Contracting Officer, who shall promptly make a determination in writing. Any adjustment by the Contractor without such a determination shall be at its own risk and expense. The Contracting Officer shall furnish from time to time such detailed drawings and other information as considered necessary, unless otherwise provided.

- (b) Wherever in the specifications or upon the drawings the words "directed", "required", "ordered", "designated", "prescribed", or words of like import are used, it shall be understood that the "direction", "requirement", "order", "designation", or "prescription", or "the Contracting Officer is intended and similarly the words "approved", "acceptable", "satisfactory", or words of like import shall mean "approved by", or "acceptable to", or "satisfactory to" the Contracting Officer, unless otherwise expressly stated.
- (c) Where "as shown" "as indicated", "as detailed", or of similar import are used, it shall be understood that the reference is made to the drawings accompanying this contract unless stated otherwise. The word "provided" as used herein shall be understood to mean "provide complete in place" that is "furnished and installed".
- (d) "Shop drawings" means drawings, submitted to the PHA by the Contractor, subcontractor, or any lower tier subcontractor, showing in detail (1) the proposed fabrication and assembly of structural elements and (2) the installation (i.e., form, fit, and attachment details) of materials of equipment. It includes drawings, diagrams, layouts, schematics, descriptive literature, illustrations, schedules, performance and test data, and similar materials furnished by the Contractor to explain in detail specific portions of the work required by the contract. The PHA may duplicate, use, and disclose in any manner and for any purpose shop drawings delivered under this contract.
- (e) If this contract requires shop drawings, the Contractor shall coordinate all such drawings, and review them for accuracy, completeness, and compliance with other contract requirements and shall indicate its approval thereon as evidence of such coordination and review. Shop drawings submitted to the Contracting Officer without evidence of the Contractor's approval may be returned for resubmission. The Contracting Officer will indicate an approval or disapproval of the shop drawings and if not approved as submitted shall indicate the PHA's reasons therefore. Any work done before such approval shall be at the Contractor's risk. Approval by the Contracting Officer shall not relieve the Contractor from responsibility for any errors or omissions in such drawings, nor from responsibility for complying with the requirements of this contract, except with respect to variations described and approved in accordance with (f) below.
- (f) If shop drawings show variations from the contract requirements, the Contractor shall describe such variations in writing, separate from the drawings, at the time of submission. If the Architect approves any such variation and the Contracting Officer concurs, the Contracting Officer shall issue an appropriate modification to the contract, except that, if the variation is minor or does not involve a change in price or in time of performance, a modification need not be issued.
- (g) It shall be the responsibility of the Contractor to make timely requests of the PHA for such large scale and full size drawings, color schemes, and other additional information, not already in his possession, which shall be

required in the planning and production of the work. Such requests may be submitted as the need arises, but each such request shall be filed in ample time to permit appropriate action to be taken by all parties involved so as to avoid delay.

- (h) The Contractor shall submit to the Contracting Officer for approval four copies (unless otherwise indicated) of all shop drawings as called for under the various headings of these specifications. Three sets (unless otherwise indicated) of all shop drawings, will be retained by the PHA and one set will be returned to the Contractor. As required by the Contracting Officer, the Contractor, upon completing the work under this contract, shall furnish a complete set of all shop drawings as finally approved. These drawings shall show all changes and revisions made up to the time the work is completed and accepted.
- (i) This clause shall be included in all subcontracts at any tier. It shall be the responsibility of the Contractor to ensure that all shop drawings prepared by subcontractors are submitted to the Contracting Officer.

10. As-Built Drawings

- (a) "As-built drawings," as used in this clause, means drawings submitted by the Contractor or subcontractor at any tier to show the construction of a particular structure or work as actually completed under the contract. "As-built drawings" shall be synonymous with "Record drawings."
- (b) As required by the Contracting Officer, the Contractor shall provide the Contracting Officer accurate information to be used in the preparation of permanent as-built drawings. For this purpose, the Contractor shall record on one set of contract drawings all changes from the installations originally indicated, and record final locations of underground lines by depth from finish grade and by accurate horizontal offset distances to permanent surface improvements such as buildings, curbs, or edges of walks.
- (c) This clause shall be included in all subcontracts at any tier. It shall be the responsibility of the Contractor to ensure that all as-built drawings prepared by subcontractors are submitted to the Contracting Officer.

11. Material and Workmanship

- (a) All equipment, material, and articles furnished under this contract shall be new and of the most suitable grade for the purpose intended, unless otherwise specifically provided in this contract. References in the contract to equipment, material, articles, or patented processes by trade name, make, or catalog number, shall be regarded as establishing a standard of quality and shall not be construed as limiting competition. The Contractor may, at its option, use any equipment, material, article, or process that, in the judgment of, and as approved by the Contracting Officer, is equal to that named in the specifications, unless otherwise specifically provided in this contract.
- (b) Approval of equipment and materials.
 - (1) The Contractor shall obtain the Contracting Officer's approval of the machinery and mechanical and other equipment to be incorporated into the work. When requesting approval, the Contractor shall furnish to the Contracting Officer the name of the manufacturer, the model number, and other information concerning the performance, capacity, nature, and rating of the

machinery and mechanical and other equipment. When required by this contract or by the Contracting Officer, the Contractor shall also obtain the Contracting Officer's approval of the material or articles which the Contractor contemplates incorporating into the work. When requesting approval, the Contractor shall provide full information concerning the material or articles. Machinery, equipment, material, and articles that do not have the required approval shall be installed or used at the risk of subsequent rejection.

- (2) When required by the specifications or the Contracting Officer, the Contractor shall submit appropriately marked samples (and certificates related to them) for approval at the Contractor's expense, with all shipping charges prepaid. The Contractor shall label, or otherwise properly mark on the container, the material or product represented, its place of origin, the name of the producer, the Contractor's name, and the identification of the construction project for which the material or product is intended to be used.
- (3) Certificates shall be submitted in triplicate, describing each sample submitted for approval and certifying that the material, equipment or accessory complies with contract requirements. The certificates shall include the name and brand of the product, name of manufacturer, and the location where produced.
- (4) Approval of a sample shall not constitute a waiver of the PHA right to demand full compliance with contract requirements. Materials, equipment and accessories may be rejected for cause even though samples have been approved.
- (5) Wherever materials are required to comply with recognized standards or specifications, such specifications shall be accepted as establishing the technical qualities and testing methods, but shall not govern the number of tests required to be made nor modify other contract requirements. The Contracting Officer may require laboratory test reports on items submitted for approval or may approve materials on the basis of data submitted in certificates with samples. Check tests will be made on materials delivered for use only as frequently as the Contracting Officer determines necessary to insure compliance of materials with the specifications. The Contractor will assume all costs of retesting materials which fail to meet contract requirements and/or testing materials offered in substitution for those found deficient.
- (6) After approval, samples will be kept in the Project office until completion of work. They may be built into the work after a substantial quantity of the materials they represent has been built in and accepted.
- (c) Requirements concerning lead-based paint. The Contractor shall comply with the requirements concerning lead-based paint contained in the Lead-Based Paint Poisoning Prevention Act (42 U.S.C. 4821-4846) as implemented by 24 CFR Part 35.

12. Permits and Codes

- (a) The Contractor shall give all notices and comply with all applicable laws, ordinances, codes, rules and regulations. Notwithstanding the requirement of the Contractor to comply with the drawings and specifications in the contract, all work installed shall comply with all applicable codes and regulations as amended by any

waivers. Before installing the work, the Contractor shall examine the drawings and the specifications for compliance with applicable codes and regulations bearing on the work and shall immediately report any discrepancy it may discover to the Contracting Officer. Where the requirements of the drawings and specifications fail to comply with the applicable code or regulation, the Contracting Officer shall modify the contract by change order pursuant to the clause entitled Changes herein to conform to the code or regulation.

- (b) The Contractor shall secure and pay for all permits, fees, and licenses necessary for the proper execution and completion of the work. Where the PHA can arrange for the issuance of all or part of these permits, fees and licenses, without cost to the Contractor, the contract amount shall be reduced accordingly.

13. Health, Safety, and Accident Prevention

(a) In performing this contract, the Contractor shall:

- (1) Ensure that no laborer or mechanic shall be required to work in surroundings or under working conditions which are unsanitary, hazardous, or dangerous to his/her health and/or safety as determined under construction safety and health standards promulgated by the Secretary of Labor by regulation;
- (2) Protect the lives, health, and safety of other persons;
- (3) Prevent damage to property, materials, supplies, and equipment; and,
- (4) Avoid work interruptions.

(b) For these purposes, the Contractor shall:

- (1) Comply with regulations and standards issued by the Secretary of Labor at 29 CFR Part 1926. Failure to comply may result in imposition of sanctions pursuant to the Contract Work Hours and Safety Standards Act (Public Law 91-54, 83 Stat. 96), 40 U.S.C. 3701 et seq.; and
- (2) Include the terms of this clause in every subcontract so that such terms will be binding on each subcontractor.

(c) The Contractor shall maintain an accurate record of exposure data on all accidents incident to work performed under this contract resulting in death, traumatic injury, occupational disease, or damage to property, materials, supplies, or equipment, and shall report this data in the manner prescribed by 29 CFR Part 1904.

(d) The Contracting Officer shall notify the Contractor of any noncompliance with these requirements and of the corrective action required. This notice, when delivered to the Contractor or the Contractor's representative at the site of the work, shall be deemed sufficient notice of the noncompliance and corrective action required. After receiving the notice, the Contractor shall immediately take corrective action. If the Contractor fails or refuses to take corrective action promptly, the Contracting Officer may issue an order stopping all or part of the work until satisfactory corrective action has been taken. The Contractor shall not base any claim or request for equitable adjustment for additional time or money on any stop order issued under these circumstances.

(e) The Contractor shall be responsible for its subcontractors' compliance with the provisions of this clause. The Contractor shall take such action with respect to any subcontract as the PHA, the Secretary of Housing and Urban Development, or the Secretary of Labor shall direct as a means of enforcing such provisions.

14. Temporary Heating

The Contractor shall provide and pay for temporary heating, covering, and enclosures necessary to properly protect all work and materials against damage by dampness and cold, to dry out the work, and to facilitate the completion of the work. Any permanent heating equipment used shall be turned over to the PHA in the condition and at the time required by the specifications.

15. Availability and Use of Utility Services

- (a) The PHA shall make all reasonably required amounts of utilities available to the Contractor from existing outlets and supplies, as specified in the contract. Unless otherwise provided in the contract, the amount of each utility service consumed shall be charged to or paid for by the Contractor at prevailing rates charged to the PHA or, where the utility is produced by the PHA, at reasonable rates determined by the Contracting Officer. The Contractor shall carefully conserve any utilities furnished without charge.
- (b) The Contractor, at its expense and in a manner satisfactory to the Contracting Officer, shall install and maintain all necessary temporary connections and distribution lines, and all meters required to measure the amount of each utility used for the purpose of determining charges. Before final acceptance of the work by the PHA, the Contractor shall remove all the temporary connections, distribution lines, meters, and associated paraphernalia.

16. Protection of Existing Vegetation, Structures, Equipment, Utilities, and Improvements

- (a) The Contractor shall preserve and protect all structures, equipment, and vegetation (such as trees, shrubs, and grass) on or adjacent to the work site, which are not to be removed under this contract, and which do not unreasonably interfere with the work required under this contract.
- (b) The Contractor shall only remove trees when specifically authorized to do so, and shall avoid damaging vegetation that will remain in place. If any limbs or branches of trees are broken during performance of this contract, or by the careless operation of equipment, or by workmen, the Contractor shall trim those limbs or branches with a clean cut and paint the cut with a tree-pruning compound as directed by the Contracting Officer.
- (c) The Contractor shall protect from damage all existing improvements and utilities (1) at or near the work site and (2) on adjacent property of a third party, the locations of which are made known to or should be known by the Contractor. Prior to disturbing the ground at the construction site, the Contractor shall ensure that all underground utility lines are clearly marked.
- (d) The Contractor shall shore up, brace, underpin, secure, and protect as necessary all foundations and other parts of existing structures adjacent to, adjoining, and in the vicinity of the site, which may be affected by the excavations or other operations connected with the construction of the project.
- (e) Any equipment temporarily removed as a result of work under this contract shall be protected, cleaned, and replaced in the same condition as at the time of award of this contract.

- (f) New work which connects to existing work shall correspond in all respects with that to which it connects and/or be similar to existing work unless otherwise required by the specifications.
- (g) No structural members shall be altered or in any way weakened without the written authorization of the Contracting Officer, unless such work is clearly specified in the plans or specifications.
- (h) If the removal of the existing work exposes discolored or unfinished surfaces, or work out of alignment, such surfaces shall be refinished, or the material replaced as necessary to make the continuous work uniform and harmonious. This, however, shall not be construed to require the refinishing or reconstruction of dissimilar finishes previously exposed, or finished surfaces in good condition, but in different planes or on different levels when brought together by the removal of intervening work, unless such refinishing or reconstruction is specified in the plans or specifications.
- (i) The Contractor shall give all required notices to any adjoining or adjacent property owner or other party before the commencement of any work.
- (j) The Contractor shall indemnify and save harmless the PHA from any damages on account of settlement or the loss of lateral support of adjoining property, any damages from changes in topography affecting drainage, and from all loss or expense and all damages for which the PHA may become liable in consequence of such injury or damage to adjoining and adjacent structures and their premises.
- (k) The Contractor shall repair any damage to vegetation, structures, equipment, utilities, or improvements, including those that are the property of a third party, resulting from failure to comply with the requirements of this contract or failure to exercise reasonable care in performing the work. If the Contractor fails or refuses to repair the damage promptly, the Contracting Officer may have the necessary work performed and charge the cost to the Contractor.

17. Temporary Buildings and Transportation of Materials

- (a) Temporary buildings (e.g., storage sheds, shops, offices, sanitary facilities) and utilities may be erected by the Contractor only with the approval of the Contracting Officer and shall be built with labor and materials furnished by the Contractor without expense to the PHA. The temporary buildings and utilities shall remain the property of the Contractor and shall be removed by the Contractor at its expense upon completion of the work. With the written consent of the Contracting Officer, the buildings and utilities may be abandoned and need not be removed.
- (b) The Contractor shall, as directed by the Contracting Officer, use only established roadways, or use temporary roadways constructed by the Contractor when and as authorized by the Contracting Officer. When materials are transported in prosecuting the work, vehicles shall not be loaded beyond the loading capacity recommended by the manufacturer of the vehicle or prescribed by any federal, state, or local law or regulation. When it is necessary to cross curbs or sidewalks, the Contractor shall protect them from damage. The Contractor shall repair or pay for the repair of any damaged curbs, sidewalks, or roads.

18. Clean Air and Water

The contractor shall comply with the Clean Air Act, as amended, 42 USC 7401 et seq., the Federal Water Pollution Control Water Act, as amended, 33 U.S.C. 1251 et seq., and standards issued pursuant thereto in the facilities in which this contract is to be performed.

19. Energy Efficiency

The Contractor shall comply with mandatory standards and policies relating to energy efficiency which are contained in the energy conservation plan issued in compliance with the Energy Policy and Conservation Act (Pub.L. 94-163) for the State in which the work under the contract is performed.

20. Inspection and Acceptance of Construction

- (a) Definitions. As used in this clause -
 - (1) "Acceptance" means the act of an authorized representative of the PHA by which the PHA approves and assumes ownership of the work performed under this contract. Acceptance may be partial or complete.
 - (2) "Inspection" means examining and testing the work performed under the contract (including, when appropriate, raw materials, equipment, components, and intermediate assemblies) to determine whether it conforms to contract requirements.
 - (3) "Testing" means that element of inspection that determines the properties or elements, including functional operation of materials, equipment, or their components, by the application of established scientific principles and procedures.
- (b) The Contractor shall maintain an adequate inspection system and perform such inspections as will ensure that the work performed under the contract conforms to contract requirements. All work is subject to PHA inspection and test at all places and at all reasonable times before acceptance to ensure strict compliance with the terms of the contract.
- (c) PHA inspections and tests are for the sole benefit of the PHA and do not: (1) relieve the Contractor of responsibility for providing adequate quality control measures; (2) relieve the Contractor of responsibility for loss or damage of the material before acceptance; (3) constitute or imply acceptance; or, (4) affect the continuing rights of the PHA after acceptance of the completed work under paragraph (j) below.
- (d) The presence or absence of the PHA inspector does not relieve the Contractor from any contract requirement, nor is the inspector authorized to change any term or condition of the specifications without the Contracting Officer's written authorization. All instructions and approvals with respect to the work shall be given to the Contractor by the Contracting Officer.
- (e) The Contractor shall promptly furnish, without additional charge, all facilities, labor, and material reasonably needed for performing such safe and convenient inspections and tests as may be required by the Contracting Officer. The PHA may charge to the Contractor any additional cost of inspection or test when work is not ready at the time specified by the Contractor for inspection or test, or when prior rejection makes reinspection or retest necessary. The PHA shall perform all inspections and tests in a manner that will not unnecessarily delay the work. Special, full size, and performance tests shall be performed as described in the contract.

- (f) The PHA may conduct routine inspections of the construction site on a daily basis.
- (g) The Contractor shall, without charge, replace or correct work found by the PHA not to conform to contract requirements, unless the PHA decides that it is in its interest to accept the work with an appropriate adjustment in contract price. The Contractor shall promptly segregate and remove rejected material from the premises.
- (h) If the Contractor does not promptly replace or correct rejected work, the PHA may (1) by contract or otherwise, replace or correct the work and charge the cost to the Contractor, or (2) terminate for default the Contractor's right to proceed.
- (i) If any work requiring inspection is covered up without approval of the PHA, it must, if requested by the Contracting Officer, be uncovered at the expense of the Contractor. If at any time before final acceptance of the entire work, the PHA considers it necessary or advisable, to examine work already completed by removing or tearing it out, the Contractor, shall on request, promptly furnish all necessary facilities, labor, and material. If such work is found to be defective or nonconforming in any material respect due to the fault of the Contractor or its subcontractors, the Contractor shall defray all the expenses of the examination and of satisfactory reconstruction. If, however, such work is found to meet the requirements of the contract, the Contracting Officer shall make an equitable adjustment to cover the cost of the examination and reconstruction, including, if completion of the work was thereby delayed, an extension of time.
- (j) The Contractor shall notify the Contracting Officer, in writing, as to the date when in its opinion all or a designated portion of the work will be substantially completed and ready for inspection. If the Architect determines that the state of preparedness is as represented, the PHA will promptly arrange for the inspection. Unless otherwise specified in the contract, the PHA shall accept, as soon as practicable after completion and inspection, all work required by the contract or that portion of the work the Contracting Officer determines and designates can be accepted separately. Acceptance shall be final and conclusive except for latent defects, fraud, gross mistakes amounting to fraud, or the PHA's right under any warranty or guarantee.

21. Use and Possession Prior to Completion

- (a) The PHA shall have the right to take possession of or use any completed or partially completed part of the work. Before taking possession of or using any work, the Contracting Officer shall furnish the Contractor a list of items of work remaining to be performed or corrected on those portions of the work that the PHA intends to take possession of or use. However, failure of the Contracting Officer to list any item of work shall not relieve the Contractor of responsibility for complying with the terms of the contract. The PHA's possession or use shall not be deemed an acceptance of any work under the contract.
- (b) While the PHA has such possession or use, the Contractor shall be relieved of the responsibility for (1) the loss of or damage to the work resulting from the PHA's possession or use, notwithstanding the terms of the clause entitled Permits and Codes herein; (2) all maintenance costs on the areas occupied; and, (3) furnishing heat, light, power, and water used in the areas

occupied without proper remuneration therefore. If prior possession or use by the PHA delays the progress of the work or causes additional expense to the Contractor, an equitable adjustment shall be made in the contract price or the time of completion, and the contract shall be modified in writing accordingly.

22. Warranty of Title

The Contractor warrants good title to all materials, supplies, and equipment incorporated in the work and agrees to deliver the premises together with all improvements thereon free from any claims, liens or charges, and agrees further that neither it nor any other person, firm or corporation shall have any right to a lien upon the premises or anything appurtenant thereto.

23. Warranty of Construction

- (a) In addition to any other warranties in this contract, the Contractor warrants, except as provided in paragraph (j) of this clause, that work performed under this contract conforms to the contract requirements and is free of any defect in equipment, material, or workmanship performed by the Contractor or any subcontractor or supplier at any tier. This warranty shall continue for a period of 2 years (one year unless otherwise indicated) from the date of final acceptance of the work. If the PHA takes possession of any part of the work before final acceptance, this warranty shall continue for a period of (one year unless otherwise indicated) from the date that the PHA takes possession.
- (b) The Contractor shall remedy, at the Contractor's expense, any failure to conform, or any defect. In addition, the Contractor shall remedy, at the Contractor's expense, any damage to PHA-owned or controlled real or personal property when the damage is the result of—
 - (1) The Contractor's failure to conform to contract requirements; or
 - (2) Any defects of equipment, material, workmanship or design furnished by the Contractor.
- (c) The Contractor shall restore any work damaged in fulfilling the terms and conditions of this clause. The Contractor's warranty with respect to work repaired or replaced will run for (one year unless otherwise indicated) from the date of repair or replacement.
- (d) The Contracting Officer shall notify the Contractor, in writing, within a reasonable time after the discovery of any failure, defect or damage.
- (e) If the Contractor fails to remedy any failure, defect, or damage within a reasonable time after receipt of notice, the PHA shall have the right to replace, repair or otherwise remedy the failure, defect, or damage at the Contractor's expense.
- (f) With respect to all warranties, express or implied, from subcontractors, manufacturers, or suppliers for work performed and materials furnished under this contract, the Contractor shall:
 - (1) Obtain all warranties that would be given in normal commercial practice;
 - (2) Require all warranties to be executed in writing, for the benefit of the PHA; and,
 - (3) Enforce all warranties for the benefit of the PHA.
- (g) In the event the Contractor's warranty under paragraph (a) of this clause has expired, the PHA may bring suit at its own expense to enforce a subcontractor's, manufacturer's or supplier's warranty.

- (h) Unless a defect is caused by the negligence of the Contractor or subcontractor or supplier at any tier, the Contractor shall not be liable for the repair of any defect of material or design furnished by the PHA nor for the repair of any damage that results from any defect in PHA furnished material or design.
- (i) Notwithstanding any provisions herein to the contrary, the establishment of the time periods in paragraphs (a) and (c) above relate only to the specific obligation of the Contractor to correct the work, and have no relationship to the time within which its obligation to comply with the contract may be sought to be enforced, nor to the time within which proceedings may be commenced to establish the Contractor's liability with respect to its obligation other than specifically to correct the work.
- (j) This warranty shall not limit the PHA's rights under the Inspection and Acceptance of Construction clause of this contract with respect to latent defects, gross mistakes or fraud.

24. Prohibition Against Liens

The Contractor is prohibited from placing a lien on the PHA's property. This prohibition shall apply to all subcontractors at any tier and all materials suppliers.

Administrative Requirements

25. Contract Period

this contract within _____ calendar days of the effective date of the contract, or within the time schedule established in the notice to proceed issued by the Contracting Officer.

26. Order of Provisions

In the event of a conflict between these General Conditions and the Specifications, the General Conditions shall prevail. In the event of a conflict between the contract and any applicable state or local law or regulation, the state or local law or regulation shall prevail; provided that such state or local law or regulation does not conflict with, or is less restrictive than applicable federal law, regulation, or Executive Order. In the event of such a conflict, applicable federal law, regulation, and Executive Order shall prevail.

27. Payments

- (a) The PHA shall pay the Contractor the price as provided in this contract.
- (b) The PHA shall make progress payments approximately every 30 days as the work proceeds, on estimates of work accomplished which meets the standards of quality established under the contract, as approved by the Contracting Officer. The PHA may, subject to written determination and approval of the Contracting Officer, make more frequent payments to contractors which are qualified small businesses.
- (c) Before the first progress payment under this contract, the Contractor shall furnish, in such detail as requested by the Contracting Officer, a breakdown of the total contract price showing the amount included therein for each principal category of the work, which shall substantiate the payment amount requested in order to provide a

basis for determining progress payments. The breakdown shall be approved by the Contracting Officer and must be acceptable to HUD. If the contract covers more than one project, the Contractor shall furnish a separate breakdown for each. The values and quantities employed in making up this breakdown are for determining the amount of progress payments and shall not be construed as a basis for additions to or deductions from the contract price. The Contractor shall prorate its overhead and profit over the construction period of the contract.

- (d) The Contractor shall submit, on forms provided by the PHA, periodic estimates showing the value of the work performed during each period based upon the approved submitted not later than 30 days in advance of the date set for payment and are subject to correction and revision as required. The estimates must be approved by the Contracting Officer with the concurrence of the Architect prior to payment. If the contract covers more than one project, the Contractor shall furnish a separate progress payment estimate for each.
- (e) Along with each request for progress payments and the required estimates, the Contractor shall furnish the following certification, or payment shall not be made: I hereby certify, to the best of my knowledge and belief, that:
 - (1) The amounts requested are only for performance in accordance with the specifications, terms, and conditions of the contract;
 - (2) Payments to subcontractors and suppliers have been made from previous payments received under the contract, and timely payments will be made from the proceeds of the payment covered by this certification, in accordance with subcontract agreements; and,
 - (3) This request for progress payments does not include any amounts which the prime contractor intends to withhold or retain from a subcontractor or supplier in accordance with the terms and conditions of the subcontract.

Name:

Title:

Date:

- (f) Except as otherwise provided in State law, the PHA shall retain ten (10) percent of the amount of progress payments until completion and acceptance of all work under the contract; except, that if upon completion of 50 percent of the work, the Contracting Officer, after consulting with the Architect, determines that the Contractor's performance and progress are satisfactory, the PHA may make the remaining payments in full for the work subsequently completed. If the Contracting Officer subsequently determines that the Contractor's performance and progress are unsatisfactory, the PHA shall reinstate the ten (10) percent (or other percentage as provided in State law) retainage until such time as the Contracting Officer determines that performance and progress are satisfactory.
- (g) The Contracting Officer may authorize material delivered on the site and preparatory work done to be taken into consideration when computing progress payments.

Material delivered to the Contractor at locations other than the site may also be taken into consideration if the Contractor furnishes satisfactory evidence that (1) it has acquired title to such material; (2) the material is properly stored in a bonded warehouse, storage yard, or similar suitable place as may be approved by the Contracting Officer; (3) the material is insured to cover its full value; and (4) the material will be used to perform this contract. Before any progress payment which includes delivered material is made, the Contractor shall furnish such documentation as the Contracting Officer may require to assure the protection of the PHA's interest in such materials. The Contractor shall remain responsible for such stored material notwithstanding the transfer of title to the PHA.

- (h) All material and work covered by progress payments made shall, at the time of payment become the sole property of the PHA, but this shall not be construed as (1) relieving the Contractor from the sole responsibility for all material and work upon which payments have been made or the restoration of any damaged work; or, (2) waiving the right of the PHA to require the fulfillment of all of the terms of the contract. In the event the work of the Contractor has been damaged by other contractors or persons other than employees of the PHA in the course of their employment, the Contractor shall restore such damaged work without cost to the PHA and to seek redress for its damage only from those who directly caused it.
- (i) The PHA shall make the final payment due the Contractor under this contract after (1) completion and final acceptance of all work; and (2) presentation of release of all claims against the PHA arising by virtue of this contract, other than claims, in stated amounts, that the Contractor has specifically excepted from the operation of the release. Each such exception shall embrace no more than one claim, the basis and scope of which shall be clearly defined. The amounts for such excepted claims shall not be included in the request for final payment. A release may also be required of the assignee if the Contractor's claim to amounts payable under this contract has been assigned.
- (j) Prior to making any payment, the Contracting Officer may require the Contractor to furnish receipts or other evidence of payment from all persons performing work and supplying material to the Contractor, if the Contracting Officer determines such evidence is necessary to substantiate claimed costs.
- (k) The PHA shall not; (1) determine or adjust any claims for payment or disputes arising there under between the Contractor and its subcontractors or material suppliers; or, (2) withhold any moneys for the protection of the subcontractors or material suppliers. The failure or refusal of the PHA to withhold moneys from the Contractor shall in no wise impair the obligations of any surety or sureties under any bonds furnished under this contract.

28. Contract Modifications

- (a) Only the Contracting Officer has authority to modify any term or condition of this contract. Any contract modification shall be authorized in writing.
- (b) The Contracting Officer may modify the contract unilaterally (1) pursuant to a specific authorization stated in a contract clause (e.g., Changes); or (2) for administrative matters which do not change the rights or

responsibilities of the parties (e.g., change in the PHA address). All other contract modifications shall be in the form of supplemental agreements signed by the Contractor and the Contracting Officer.

- (c) When a proposed modification requires the approval of HUD prior to its issuance (e.g., a change order that exceeds the PHA's approved threshold), such modification shall not be effective until the required approval is received by the PHA.

29. Changes

- (a) The Contracting Officer may, at any time, without notice to the sureties, by written order designated or indicated to be a change order, make changes in the work within the general scope of the contract including changes:
 - (1) In the specifications (including drawings and designs);
 - (2) In the method or manner of performance of the work;
 - (3) PHA-furnished facilities, equipment, materials, services, or site; or,
 - (4) Directing the acceleration in the performance of the work.
- (b) Any other written order or oral order (which, as used in this paragraph (b), includes direction, instruction, interpretation, or determination) from the Contracting Officer that causes a change shall be treated as a change order under this clause; provided, that the Contractor gives the Contracting Officer written notice stating (1) the date, circumstances and source of the order and (2) that the Contractor regards the order as a change order.
- (c) Except as provided in this clause, no order, statement or conduct of the Contracting Officer shall be treated as a change under this clause or entitle the Contractor to an equitable adjustment.
- (d) If any change under this clause causes an increase or decrease in the Contractor's cost of, or the time required for the performance of any part of the work under this contract, whether or not changed by any such order, the Contracting Officer shall make an equitable adjustment and modify the contract in writing. However, except for a adjustment based on defective specifications, no proposal for any change under paragraph (b) above shall be allowed for any costs incurred more than 20 days (5 days for oral orders) before the Contractor gives written notice as required. In the case of defective specifications for which the PHA is responsible, the equitable adjustment shall include any increased cost reasonably incurred by the Contractor in attempting to comply with the defective specifications.
- (e) The Contractor must assert its right to an adjustment under this clause within 30 days after (1) receipt of a written change order under paragraph (a) of this clause, or (2) the furnishing of a written notice under paragraph (b) of this clause, by submitting a written statement describing the general nature and the amount of the proposal. If the facts justify it, the Contracting Officer may extend the period for submission. The proposal may be included in the notice required under paragraph (b) above. No proposal by the Contractor for an equitable adjustment shall be allowed if asserted after final payment under this contract.
- (f) The Contractor's written proposal for equitable adjustment shall be submitted in the form of a lump sum proposal supported with an itemized breakdown of all increases and decreases in the contract in at least the following details:

- (1) Direct Costs. Materials (list individual items, the quantity and unit cost of each, and the aggregate cost); Transportation and delivery costs associated with materials; Labor breakdowns by hours or unit costs (identified with specific work to be performed); Construction equipment exclusively necessary for the change; Costs of preparation and/ or revision to shop drawings resulting from the change; Worker's Compensation and Public Liability Insurance; Employment taxes under FICA and FUTA; and, Bond Costs when size of change warrants revision.
- (2) Indirect Costs. Indirect costs may include overhead, general and administrative expenses, and fringe benefits not normally treated as direct costs.
- (3) Profit. The amount of profit shall be negotiated and may vary according to the nature, extent, and complexity of the work required by the change. The allowability of the direct and indirect costs shall be determined in accordance with the Contract Cost Principles and Procedures for Commercial Firms in Part 31 of the Federal Acquisition Regulation (48 CFR 1-31), as implemented by HUD Handbook 2210.18, in effect on the date of this contract. The Contractor shall not be allowed a profit on the profit received by any subcontractor. Equitable adjustments for deleted work shall include a credit for profit and may include a credit for indirect costs. On proposals covering both increases and decreases in the amount of the contract, the application of indirect costs and profit shall be on the net-change in direct costs for the Contractor or subcontractor performing the work.
- (g) The Contractor shall include in the proposal its request for time extension (if any), and shall include sufficient information and dates to demonstrate whether and to what extent the change will delay the completion of the contract in its entirety.
- (h) The Contracting Officer shall act on proposals within 30 days after their receipt, or notify the Contractor of the date when such action will be taken.
- (i) Failure to reach an agreement on any proposal shall be a dispute under the clause entitled Disputes herein. Nothing in this clause, however, shall excuse the Contractor from proceeding with the contract as changed.
- (j) Except in an emergency endangering life or property, no change shall be made by the Contractor without a prior order from the Contracting Officer.

30. Suspension of Work

- (a) The Contracting Officer may order the Contractor in writing to suspend, delay, or interrupt all or any part of the work of this contract for the period of time that the Contracting Officer determines appropriate for the convenience of the PHA.
- (b) If the performance of all or any part of the work is, for an unreasonable period of time, suspended, delayed, or interrupted (1) by an act of the Contracting Officer in the administration of this contract, or (2) by the Contracting Officer's failure to act within the time specified (or within a reasonable time if not specified) in this contract an adjustment shall be made for any increase in the cost of performance of the contract (excluding profit) necessarily caused by such unreasonable suspension, delay, or interruption and the contract modified in writing accordingly. However, no adjustment shall be made under this clause for any suspension, delay, or interruption to the extent that performance would have

been so suspended, delayed, or interrupted by any other cause, including the fault or negligence of the Contractor or for which any equitable adjustment is provided for or excluded under any other provision of this contract.

- (c) A claim under this clause shall not be allowed (1) for any costs incurred more than 20 days before the Contractor shall have notified the Contracting Officer in writing of the act or failure to act involved (but this requirement shall not apply as to a claim resulting from a suspension order); and, (2) unless the claim, in an amount stated, is asserted in writing as soon as practicable after the termination of the suspension, delay, or interruption, but not later than the date of final payment under the contract.

31. Disputes

- (a) "Claim," as used in this clause, means a written demand or written assertion by one of the contracting parties seeking, as a matter of right, the payment of money in a sum certain, the adjustment or interpretation of contract terms, or other relief arising under or relating to the contract. A claim arising under the contract, unlike a claim relating to the contract, is a claim that can be resolved under a contract clause that provides for the relief sought by the claimant. A voucher, invoice, or other routine request for payment that is not in dispute when submitted is not a claim. The submission may be converted to a claim by complying with the requirements of this clause, if it is disputed either as to liability or amount or is not acted upon in a reasonable time.
- (b) Except for disputes arising under the clauses entitled Labor Standards - Davis Bacon and Related Acts, herein, all disputes arising under or relating to this contract, including any claims for damages for the alleged breach thereof which are not disposed of by agreement, shall be resolved under this clause.
- (c) All claims by the Contractor shall be made in writing and submitted to the Contracting Officer for a written decision. A claim by the PHA against the Contractor shall be subject to a written decision by the Contracting Officer.
- (d) The Contracting Officer shall, within 60 (unless otherwise indicated) days after receipt of the request, decide the claim or notify the Contractor of the date by which the decision will be made.
- (e) The Contracting Officer's decision shall be final unless the Contractor (1) appeals in writing to a higher level in the PHA in accordance with the PHA's policy and procedures, (2) refers the appeal to an independent mediator or arbitrator, or (3) files suit in a court of competent jurisdiction. Such appeal must be made within (30 unless otherwise indicated) days after receipt of the Contracting Officer's decision.
- (f) The Contractor shall proceed diligently with performance of this contract, pending final resolution of any request for relief, claim, appeal, or action arising under or relating to the contract, and comply with any decision of the Contracting Officer.

32. Default

- (a) If the Contractor refuses or fails to prosecute the work, or any separable part thereof, with the diligence that will insure its completion within the time specified in this contract, or any extension thereof, or fails to complete said work within this time, the Contracting Officer may, by written notice to the Contractor, terminate the right to

proceed with the work (or separable part of the work) that has been delayed. In this event, the PHA may take over the work and complete it, by contract or otherwise, and may take possession of and use any materials, equipment, and plant on the work site necessary for completing the work. The Contractor and its sureties shall be liable for any damage to the PHA resulting from the Contractor's refusal or failure to complete the work within the specified time, whether or not the Contractor's right to proceed with the work is terminated. This liability includes any increased costs incurred by the PHA in completing the work.

- (b) The Contractor's right to proceed shall not be terminated or the Contractor charged with damages under this clause if—
- (1) The delay in completing the work arises from unforeseeable causes beyond the control and without the fault or negligence of the Contractor. Examples of such causes include (i) acts of God, or of the public enemy, (ii) acts of the PHA or other governmental entity in either its sovereign or contractual capacity, (iii) acts of another contractor in the performance of a contract with the PHA, (iv) fires, (v) floods, (vi) epidemics, (vii) quarantine restrictions, (viii) strikes, (ix) freight embargoes, (x) unusually severe weather, or (xi) delays of subcontractors or suppliers at any tier arising from unforeseeable causes beyond the control and without the fault or negligence of both the Contractor and the subcontractors or suppliers; and
 - (2) The Contractor, within days (10 days unless otherwise indicated) from the beginning of such delay (unless extended by the Contracting Officer) notifies the Contracting Officer in writing of the causes of delay. The Contracting Officer shall ascertain the facts and the extent of the delay. If, in the judgment of the Contracting Officer, the findings of fact warrant such action, time for completing the work shall be extended by written modification to the contract. The findings of the Contracting Officer shall be reduced to a written decision which shall be subject to the provisions of the Disputes clause of this contract.
- (c) If, after termination of the Contractor's right to proceed, it is determined that the Contractor was not in default, or that the delay was excusable, the rights and obligations of the parties will be the same as if the termination had been for convenience of the PHA.

33. Liquidated Damages

- (a) If the Contractor fails to complete the work within the time specified in the contract, or any extension, as specified in the clause entitled Default of this contract, the Contractor shall pay to the PHA as liquidated damages, the sum of \$ _____ [Contracting Officer insert amount] for each day of delay. If different completion dates are specified in the contract for separate parts or stages of the work, the amount of liquidated damages shall be assessed on those parts or stages which are delayed. To the extent that the Contractor's delay or nonperformance is excused under another clause in this contract, liquidated damages shall not be due the PHA. The Contractor remains liable for damages caused other than by delay.
- (b) If the PHA terminates the Contractor's right to proceed, the resulting damage will consist of liquidated damages until such reasonable time as may be required for final

completion of the work together with any increased costs occasioned the PHA in completing the work.

- (c) If the PHA does not terminate the Contractor's right to proceed, the resulting damage will consist of liquidated damages until the work is completed or accepted.

34. Termination for Convenience

- (a) The Contracting Officer may terminate this contract in whole, or in part, whenever the Contracting Officer determines that such termination is in the best interest of the PHA. Any such termination shall be effected by delivery to the Contractor of a Notice of Termination specifying the extent to which the performance of the work under the contract is terminated, and the date upon which such termination becomes effective.
- (b) If the performance of the work is terminated, either in whole or in part, the PHA shall be liable to the Contractor for reasonable and proper costs resulting from such termination upon the receipt by the PHA of a properly presented claim setting out in detail: (1) the total cost of the work performed to date of termination less the total amount of contract payments made to the Contractor; (2) the cost (including reasonable profit) of settling and paying claims under subcontracts and material orders for work performed and materials and supplies delivered to the site, payment for which has not been made by the PHA to the Contractor or by the Contractor to the subcontractor or supplier; (3) the cost of preserving and protecting the work already performed until the PHA or assignee takes possession thereof or assumes responsibility therefore; (4) the actual or estimated cost of legal and accounting services reasonably necessary to prepare and present the termination claim to the PHA; and (5) an amount constituting a reasonable profit on the value of the work performed by the Contractor.
- (c) The Contracting Officer will act on the Contractor's claim within days (60 days unless otherwise indicated) of receipt of the Contractor's claim.
- (d) Any disputes with regard to this clause are expressly made subject to the provisions of the Disputes clause of this contract.

35. Assignment of Contract

The Contractor shall not assign or transfer any interest in this contract; except that claims for monies due or to become due from the PHA under the contract may be assigned to a bank, trust company, or other financial institution. Such assignments of claims shall only be made with the written concurrence of the Contracting Officer. If the Contractor is a partnership, this contract shall inure to the benefit of the surviving or remaining member(s) of such partnership as approved by the Contracting Officer.

36. Insurance

- (a) Before commencing work, the Contractor and each subcontractor shall furnish the PHA with certificates of insurance showing the following insurance is in force and will insure all operations under the Contract:
- (1) Workers' Compensation, in accordance with state or Territorial Workers' Compensation laws.
 - (2) Commercial General Liability with a combined single limit for bodily injury and property damage of not less than \$ 2MM [Contracting Officer insert amount]

per occurrence to protect the Contractor and each subcontractor against claims for bodily injury or death and damage to the property of others. This shall cover the use of all equipment, hoists, and vehicles on the site(s) not covered by Automobile Liability under (3) below. If the Contractor has a "claims made" policy, then the following additional requirements apply: the policy must provide a "retroactive date" which must be on or before the execution date of the Contract; and the extended reporting period may not be less than five years following the completion date of the Contract.

- (3) Automobile Liability on owned and non-owned motor vehicles used on the site(s) or in connection therewith for a combined single limit for bodily injury and property damage of not less than \$ 500K [Contracting Officer insert amount] per occurrence.
- (b) Before commencing work, the Contractor shall furnish the PHA with a certificate of insurance evidencing that Builder's Risk (fire and extended coverage) Insurance on all work in place and/or materials stored at the building site(s), including foundations and building equipment, is in force. The Builder's Risk Insurance shall be for the benefit of the Contractor and the PHA as their interests may appear and each shall be named in the policy or policies as an insured. The Contractor in installing equipment supplied by the PHA shall carry insurance on such equipment from the time the Contractor takes possession thereof until the Contract work is accepted by the PHA. The Builder's Risk Insurance need not be carried on excavations, piers, footings, or foundations until such time as work on the superstructure is started. It need not be carried on landscape work. Policies shall furnish coverage at all times for the full cash value of all completed construction, as well as materials in place and/or stored at the site(s), whether or not partial payment has been made by the PHA. The Contractor may terminate this insurance on buildings as of the date taken over for occupancy by the PHA. The Contractor is not required to carry Builder's Risk Insurance for modernization work which does not involve structural alterations or additions and where the PHA's existing fire and extended coverage policy can be endorsed to include such work.
- (c) All insurance shall be carried with companies which are financially responsible and admitted to do business in the State in which the project is located. If any such insurance is due to expire during the construction period, the Contractor (including subcontractors, as applicable) shall not permit the coverage to lapse and shall furnish evidence of coverage to the Contracting Officer. All certificates of insurance, as evidence of coverage, shall provide that no coverage may be canceled or non-renewed by the insurance company until at least 30 days prior written notice has been given to the Contracting Officer.

37. Subcontracts

- (a) Definitions. As used in this contract -
- (1) "Subcontract" means any contract, purchase order, or other purchase agreement, including modifications and change orders to the foregoing, entered into by a subcontractor to furnish supplies, materials, equipment, and services for the performance of the prime contract or a subcontract.

(2) "Subcontractor" means any supplier, vendor, or firm that furnishes supplies, materials, equipment, or services to or for the Contractor or another subcontractor.

- (b) The Contractor shall not enter into any subcontract with any subcontractor who has been temporarily denied participation in a HUD program or who has been suspended or debarred from participating in contracting programs by any agency of the United States Government or of the state in which the work under this contract is to be performed.
- (c) The Contractor shall be as fully responsible for the acts or omissions of its subcontractors, and of persons either directly or indirectly employed by them as for the acts or omissions of persons directly employed by the Contractor.
- (d) The Contractor shall insert appropriate clauses in all subcontracts to bind subcontractors to the terms and conditions of this contract insofar as they are applicable to the work of subcontractors.
- (e) Nothing contained in this contract shall create any contractual relationship between any subcontractor and the PHA or between the subcontractor and HUD.

38. Subcontracting with Small and Minority Firms, Women's Business Enterprise, and Labor Surplus Area Firms

The Contractor shall take the following steps to ensure that, whenever possible, subcontracts are awarded to small business firms, minority firms, women's business enterprises, and labor surplus area firms:

- (a) Placing qualified small and minority businesses and women's business enterprises on solicitation lists;
- (b) Ensuring that small and minority businesses and women's business enterprises are solicited whenever they are potential sources;
- (c) Dividing total requirements, when economically feasible, into smaller tasks or quantities to permit maximum participation by small and minority businesses and women's business enterprises;
- (d) Establishing delivery schedules, where the requirements of the contract permit, which encourage participation by small and minority businesses and women's business enterprises; and
- (e) Using the services and assistance of the U.S. Small Business Administration, the Minority Business Development Agency of the U.S. Department of Commerce, and State and local governmental small business agencies.

39. Equal Employment Opportunity

During the performance of this contract, the Contractor agrees as follows:

- (a) The Contractor shall not discriminate against any employee or applicant for employment because of race, color, religion, sex, national origin, or handicap.
- (b) The Contractor shall take affirmative action to ensure that applicants are employed, and that employees are treated during employment without regard to their race, color, religion, sex, national origin, or handicap. Such action shall include, but not be limited to, (1) employment, (2) upgrading, (3) demotion, (4) transfer, (5) recruitment or recruitment advertising, (6) layoff or termination, (7) rates of pay or other forms of compensation, and (8) selection for training, including apprenticeship.

- (c) The Contractor shall post in conspicuous places available to employees and applicants for employment the notices to be provided by the Contracting Officer that explain this clause.
- (d) The Contractor shall, in all solicitations or advertisements for employees placed by or on behalf of the Contractor, state that all qualified applicants will receive consideration for employment without regard to race, color, religion, sex, national origin, or handicap.
- (e) The Contractor shall send, to each labor union or representative of workers with which it has a collective bargaining agreement or other contract or understanding, the notice to be provided by the Contracting Officer advising the labor union or workers' representative of the Contractor's commitments under this clause, and post copies of the notice in conspicuous places available to employees and applicants for employment.
- (f) The Contractor shall comply with Executive Order 11246, as amended, and the rules, regulations, and orders of the Secretary of Labor.
- (g) The Contractor shall furnish all information and reports required by Executive Order 11246, as amended, Section 503 of the Rehabilitation Act of 1973, as amended, and by rules, regulations, and orders of the Secretary of Labor, or pursuant thereto. The Contractor shall permit access to its books, records, and accounts by the Secretary of Labor for purposes of investigation to ascertain compliance with such rules, regulations, and orders.
- (h) In the event of a determination that the Contractor is not in compliance with this clause or any rule, regulation, or order of the Secretary of Labor, this contract may be canceled, terminated, or suspended in whole or in part, and the Contractor may be declared ineligible for further Government contracts, or Federally assisted construction contracts under the procedures authorized in Executive Order 11246, as amended. In addition, sanctions may be imposed and remedies invoked against the Contractor as provided in Executive Order 11246, as amended, the rules, regulations, and orders of the Secretary of Labor, or as otherwise provided by law.
- (i) The Contractor shall include the terms and conditions of this clause in every subcontract or purchase order unless exempted by the rules, regulations, or orders of the Secretary of Labor issued under Executive Order 11246, as amended, so that these terms and conditions will be binding upon each subcontractor or vendor. The Contractor shall take such action with respect to any subcontract or purchase order as the Secretary of Housing and Urban Development or the Secretary of Labor may direct as a means of enforcing such provisions, including sanctions for noncompliance; provided that if the Contractor becomes involved in, or is threatened with, litigation with a subcontractor or vendor as a result of such direction, the Contractor may request the United States to enter into the litigation to protect the interests of the United States.
- (j) Compliance with the requirements of this clause shall be to the maximum extent consistent with, but not in derogation of, compliance with section 7(b) of the Indian Self-Determination and Education Assistance Act and the Indian Preference clause of this contract.
- 40. Employment, Training, and Contracting Opportunities for Low-Income Persons, Section 3 of the Housing and Urban Development Act of 1968.**
- (a) The work to be performed under this contract is subject to the requirements of section 3 of the Housing and Urban Development Act of 1968, as amended, 12 U.S.C. 1701u (section 3). The purpose of section 3 is to ensure that employment and other economic opportunities generated by HUD assistance or HUD-assisted projects covered by section 3, shall, to the greatest extent feasible, be directed to low- and very low-income persons, particularly persons who are recipients of HUD assistance for housing.
- (b) The parties to this contract agree to comply with HUD's regulations in 24 CFR Part 135, which implement section 3. As evidenced by their execution of this contract, the parties to this contract certify that they are under no contractual or other impediment that would prevent them from complying with the Part 135 regulations.
- (c) The contractor agrees to send to each labor organization or representative of workers with which the contractor has a collective bargaining agreement or other understanding, if any, a notice advising the labor organization or workers' representative of the contractor's commitments under this section 3 clause, and will post copies of the notice in conspicuous places at the work site where both employees and applicants for training and employment positions can see the notice. The notice shall describe the section 3 preference, shall set forth minimum number and job titles subject to hire, availability of apprenticeship and training positions, the qualifications for each; and the name and location of the person(s) taking applications for each of the positions; and the anticipated date the work shall begin.
- (d) The contractor agrees to include this section 3 clause in every subcontract subject to compliance with regulations in 24 CFR Part 135, and agrees to take appropriate action, as provided in an applicable provision of the subcontract or in this section 3 clause, upon a finding that the subcontractor is in violation of the regulations in 24 CFR Part 135. The contractor will not subcontract with any subcontractor where the contractor has notice or knowledge that the subcontractor has been found in violation of the regulations in 24 CFR Part 135.
- (e) The contractor will certify that any vacant employment positions, including training positions, that are filled (1) after the contractor is selected but before the contract is executed, and (2) with persons other than those to whom the regulations of 24 CFR Part 135 require employment opportunities to be directed, were not filled to circumvent the contractor's obligations under 24 CFR Part 135.
- (f) Noncompliance with HUD's regulations in 24 CFR Part 135 may result in sanctions, termination of this contract for default, and debarment or suspension from future HUD assisted contracts.
- (g) With respect to work performed in connection with section 3 covered Indian housing assistance, section 7(b) of the Indian Self-Determination and Education Assistance Act (25 U.S.C. 450e) also applies to the work to be performed under this contract. Section 7(b) requires that to the greatest extent feasible (i) preference and opportunities for training and employment shall be given to Indians, and (ii) preference in the award of contracts and subcontracts shall be given to Indian organizations and Indian-owned Economic Enterprises. Parties to this contract that are subject to the provisions of section 3 and section 7(b) agree to comply with section 3 to the maximum extent feasible, but not in derogation of compliance with section 7(b).

41. Interest of Members of Congress

No member of or delegate to the Congress of the United States of America shall be admitted to any share or part of this contract or to any benefit that may arise therefrom.

42. Interest of Members, Officers, or Employees and Former Members, Officers, or Employees

No member, officer, or employee of the PHA, no member of the governing body of the locality in which the project is situated, no member of the governing body of the locality in which the PHA was activated, and no other public official of such locality or localities who exercises any functions or responsibilities with respect to the project, shall, during his or her tenure, or for one year thereafter, have any interest, direct or indirect, in this contract or the proceeds thereof.

43. Limitations on Payments made to Influence Certain Federal Financial Transactions

- (a) The Contractor agrees to comply with Section 1352 of Title 31, United States Code which prohibits the use of Federal appropriated funds to pay any person for influencing or attempting to influence an officer or employee of any agency, a Member of Congress, and officer or employee of Congress, or an employee of a Member of Congress in connection with any of the following covered Federal actions: the awarding of any Federal contract; the making of any Federal grant; the making of any Federal loan; the entering into of any cooperative agreement; or the modification of any Federal contract, grant, loan, or cooperative agreement.
- (b) The Contractor further agrees to comply with the requirement of the Act to furnish a disclosure (OMB Standard Form LLL, Disclosure of Lobbying Activities) if any funds other than Federal appropriated funds (including profit or fee received under a covered Federal transaction) have been paid, or will be paid, to any person for influencing or attempting to influence an officer or employee of any agency, a Member of Congress, an officer or employee of Congress, or an employee of a Member of Congress in connection with a Federal contract, grant, loan, or cooperative agreement.

44. Royalties and Patents

The Contractor shall pay all royalties and license fees. It shall defend all suits or claims for infringement of any patent rights and shall save the PHA harmless from loss on account thereof; except that the PHA shall be responsible for all such loss when a particular design, process or the product of a particular manufacturer or manufacturers is specified and the Contractor has no reason to believe that the specified design, process, or product is an infringement. If, however, the Contractor has reason to believe that any design, process or product specified is an infringement of a patent, the Contractor shall promptly notify the Contracting Officer. Failure to give such notice shall make the Contractor responsible for resultant loss.

45. Examination and Retention of Contractor's Records

- (a) The PHA, HUD, or Comptroller General of the United States, or any of their duly authorized representatives shall, until 3 years after final payment under this contract, have access to and the right to examine any of the Contractor's directly pertinent books, documents, papers, or other records involving transactions related to this contract for the purpose of making audit, examination, excerpts, and transcriptions.
- (b) The Contractor agrees to include in first-tier subcontracts under this contract a clause substantially the same as paragraph (a) above. "Subcontract," as used in this clause, excludes purchase orders not exceeding \$10,000.
- (c) The periods of access and examination in paragraphs (a) and (b) above for records relating to (1) appeals under the Disputes clause of this contract, (2) litigation or settlement of claims arising from the performance of this contract, or (3) costs and expenses of this contract to which the PHA, HUD, or Comptroller General or any of their duly authorized representatives has taken exception shall continue until disposition of such appeals, litigation, claims, or exceptions.

46. Labor Standards - Davis-Bacon and Related Acts

If the total amount of this contract exceeds \$2,000, the Federal labor standards set forth in the clause below shall apply to the development or construction work to be performed under the contract.

- (a) Minimum Wages.
 - (1) All laborers and mechanics employed under this contract in the development or construction of the project(s) involved will be paid unconditionally and not less often than once a week, and without subsequent deduction or rebate on any account (except such payroll deductions as are permitted by regulations issued by the Secretary of Labor under the Copeland Act (29 CFR Part 3)), the full amount of wages and bona fide fringe benefits (or cash equivalents thereof) due at time of payment computed at rates not less than those contained in the wage determination of the Secretary of Labor which is attached hereto and made a part hereof, regardless of any contractual relationship which may be alleged to exist between the Contractor and such laborers and mechanics. Contributions made or costs reasonably anticipated for bona fide fringe benefits under Section 1(b)(2) of the Davis-Bacon Act on behalf of laborers or mechanics are considered wages paid to such laborers or mechanics, subject to the provisions of 29 CFR 5.5(a)(1)(iv); also, regular contributions made or costs incurred for more than a weekly period (but not less often than quarterly) under plans, funds, or programs which cover the regular weekly period, are deemed to be constructively made or incurred during such weekly period. Such laborers and mechanics shall be paid the appropriate wage rate and fringe benefits in the wage determination for the classification of work actually performed, without regard to skill, except as provided in 29 CFR 5.5(a)(4). Laborers or mechanics performing work in more than one classification may be compensated at the rate specified for each classification for the time actually worked therein; provided, that the employer's payroll records accurately set forth the time spent in each classification in which work is performed. The wage determination (including any additional classification and wage rates conformed under 29 CFR 5.5(a)(1)(ii) and the Davis-Bacon poster (WH-1321) shall

be posted at all times by the Contractor and its subcontractors at the site of the work in a prominent and accessible place where it can be easily seen by the workers.

- (2) (i) Any class of laborers or mechanics, including helpers, which is not listed in the wage determination and which is to be employed under the contract shall be classified in conformance with the wage determination. HUD shall approve an additional classification and wage rate and fringe benefits therefor only when all the following criteria have been met: (A) The work to be performed by the classification requested is not performed by a classification in the wage determination; and (B) The classification is utilized in the area by the construction industry; and (C) The proposed wage rate, including any bona fide fringe benefits, bears a reasonable relationship to the wage rates contained in the wage determination.
- (ii) If the Contractor and the laborers and mechanics to be employed in the classification (if known), or their representatives, and HUD or its designee agree on the classification and wage rate (including the amount designated for fringe benefits where appropriate), a report of the action taken shall be sent by HUD or its designee to the Administrator of the Wage and Hour Division, Employee Standards Administration, U.S. Department of Labor, Washington, DC 20210. The Administrator, or an authorized representative, will approve, modify, or disapprove every additional classification action within 30 days of receipt and so advise HUD or its designee or will notify HUD or its designee within the 30-day period that additional time is necessary.
- (iii) In the event the Contractor, the laborers or mechanics to be employed in the classification or their representatives, and HUD or its designee do not agree on the proposed classification and wage rate (including the amount designated for fringe benefits, where appropriate), HUD or its designee shall refer the questions, including the views of all interested parties and the recommendation of HUD or its designee, to the Administrator of the Wage and Hour Division for determination. The Administrator, or an authorized representative, will issue a determination within 30 days of receipt and so advise HUD or its designee or will notify HUD or its designee within the 30-day period that additional time is necessary.
- (iv) The wage rate (including fringe benefits where appropriate) determined pursuant to subparagraphs (a)(2)(ii) or (iii) of this clause shall be paid to all workers performing work in the classification under this contract from the first day on which work is performed in classification.
- (3) Whenever the minimum wage rate prescribed in the contract for a class of laborers or mechanics includes a fringe benefit which is not expressed as an hourly rate, the Contractor shall either pay the benefit as stated in the wage determination or shall pay another bona fide fringe benefit or an hourly cash equivalent thereof.
- (4) If the Contractor does not make payments to a trustee or other third person, the Contractor may consider as part of the wages of any laborer or mechanic the

amount of any costs reasonably anticipated in providing bona fide fringe benefits under a plan or program; provided, that the Secretary of Labor has found, upon the written request of the Contractor, that the applicable standards of the Davis-Bacon Act have been met. The Secretary of Labor may require the Contractor to set aside in a separate account assets for the meeting of obligations under the plan or program.

- (b) Withholding of funds. HUD or its designee shall, upon its own action or upon written request of an authorized representative of the Department of Labor, withhold or cause to be withheld from the Contractor under this contract or any other Federal contract with the same prime Contractor, or any other Federally-assisted contract subject to Davis-Bacon prevailing wage requirements, which is held by the same prime Contractor, so much of the accrued payments or advances as may be considered necessary to pay laborers and mechanics, including apprentices, trainees, and helpers, employed by the Contractor or any subcontractor the full amount of wages required by the contract. In the event of failure to pay any laborer or mechanic, including any apprentice, trainee, or helper, employed or working in the construction or development of the project, all or part of the wages required by the contract, HUD or its designee may, after written notice to the Contractor, take such action as may be necessary to cause the suspension of any further payment, advance, or guarantee of funds until such violations have ceased. HUD or its designee may, after written notice to the Contractor, disburse such amounts withheld for and on account of the Contractor or subcontractor to the respective employees to whom they are due.
- (c) Payrolls and basic records.
- (1) Payrolls and basic records relating thereto shall be maintained by the Contractor during the course of the work and preserved for a period of three years thereafter for all laborers and mechanics working in the construction or development of the project. Such records shall contain the name, address, and social security number of each such worker, his or her correct classification, hourly rates of wages paid (including rates of contributions or costs anticipated for bona fide fringe benefits or cash equivalents thereof of the types described in section 1(b)(2)(B) of the Davis-Bacon Act), daily and weekly number of hours worked, deductions made, and actual wages paid. Whenever the Secretary of Labor has found, under 29 CFR 5.5(a)(1)(iv), that the wages of any laborer or mechanic include the amount of costs reasonably anticipated in providing benefits under a plan or program described in section 1(b)(2)(B) of the Davis-Bacon Act, the Contractor shall maintain records which show that the commitment to provide such benefits is enforceable, that the plan or program is financially responsible, and that the plan or program has been communicated in writing to the laborers or mechanics affected, and records which show the costs anticipated or the actual cost incurred in providing such benefits. Contractors employing apprentices or trainees under approved programs shall maintain written evidence of the registration of apprenticeship programs and certification of trainee programs, the registration of the apprentices and trainees, and the ratios and wage rates prescribed in the applicable programs.

- (2) (i) The Contractor shall submit weekly for each week in which any contract work is performed a copy of all payrolls to the Contracting Officer for transmission to HUD or its designee. The payrolls submitted shall set out accurately and completely all of the information required to be maintained under subparagraph (c)(1) of this clause. This information may be submitted in any form desired. Optional Form WH-347 (Federal Stock Number 029-005-00014-1) is available for this purpose and may be purchased from the Superintendent of Documents, U.S. Government Printing Office, Washington, D.C. 20402. The Contractor is responsible for the submission of copies of payrolls by all subcontractors. (Approved by the Office of Management and Budget under OMB Control Number 1214-0149.)
- (ii) Each payroll submitted shall be accompanied by a "Statement of Compliance," signed by the Contractor or subcontractor or his or her agent who pays or supervises the payment of the persons employed under the contract and shall certify the following:
- (A) That the payroll for the payroll period contains the information required to be maintained under paragraph (c) (1) of this clause and that such information is correct and complete;
- (B) That each laborer or mechanic (including each helper, apprentice, and trainee) employed on the contract during the payroll period has been paid the full weekly wages earned, without rebate, either directly or indirectly, and that no deductions have been made either directly or indirectly from the full wages earned, other than permissible deductions as set forth in 29 CFR Part 3; and
- (C) That each laborer or mechanic has been paid not less than the applicable wage rates and fringe benefits or cash equivalents for the classification of work performed, as specified in the applicable wage determination incorporated into the contract.
- (iii) The weekly submission of a properly executed certification set forth on the reverse side of Optional Form WH-347 shall satisfy the requirements for submission of the "Statement of Compliance" required by subparagraph (c)(2)(ii) of this clause.
- (iv) The falsification of any of the above certifications may subject the Contractor or subcontractor to civil or criminal prosecution under Section 1001 of Title 18 and Section 3729 of Title 31 of the United States Code.
- (3) The Contractor or subcontractor shall make the records required under subparagraph (c)(1) available for inspection, copying, or transcription by authorized representatives of HUD or its designee, the Contracting Officer, or the Department of Labor and shall permit such representatives to interview employees during working hours on the job. If the Contractor or subcontractor fails to submit the required records or to make them available, HUD or its designee may, after written notice to the Contractor, take such action as may be necessary to cause the suspension of any further payment, advance, or guarantee of funds. Furthermore, failure to submit the required records upon request or to

make such records available may be grounds for debarment action pursuant to 29 CFR 5.12.

- (d) (1) Apprentices. Apprentices will be permitted to work at less than the predetermined rate for the work they performed when they are employed pursuant to and individually registered in a bona fide apprenticeship program registered with the U.S. Department of Labor, Employment and Training Administration, Office of Apprenticeship and Training, Employer and Labor Services (OATELS), or with a State Apprenticeship Agency recognized by OATELS, or if a person is employed in his or her first 90 days of probationary employment as an apprentice in such an apprenticeship program, who is not individually registered in the program, but who has been certified by OATELS or a State Apprenticeship Agency (where appropriate) to be eligible for probationary employment as an apprentice. The allowable ratio of apprentices to journeymen on the job site in any craft classification shall not be greater than the ratio permitted to the Contractor as to the entire work force under the registered program. Any worker listed on a payroll at an apprentice wage rate, who is not registered or otherwise employed as stated in this paragraph, shall be paid not less than the applicable wage rate on the wage determination for the classification of work actually performed. In addition, any apprentice performing work on the job site in excess of the ratio permitted under the registered program shall be paid not less than the applicable wage rate on the wage determination for the work actually performed. Where a contractor is performing construction on a project in a locality other than that in which its program is registered, the ratios and wage rates (expressed in percentages of the journeyman's hourly rate) specified in the Contractor's or subcontractor's registered program shall be observed. Every apprentice must be paid at not less than the rate specified in the registered program for the apprentice's level of progress, expressed as a percentage of the journeyman hourly rate specified in the applicable wage determination. Apprentices shall be paid fringe benefits in accordance with the provisions of the apprenticeship program. If the apprenticeship program does not specify fringe benefits, apprentices must be paid the full amount of fringe benefits listed on the wage determination for the applicable classification. If the Administrator of the Wage and Hour Division determines that a different practice prevails for the applicable apprentice classification, fringes shall be paid in accordance with that determination. In the event OATELS, or a State Apprenticeship Agency recognized by OATELS, withdraws approval of an apprenticeship program, the Contractor will no longer be permitted to utilize apprentices at less than the applicable predetermined rate for the work performed until an acceptable program is approved.
- (2) Trainees. Except as provided in 29 CFR 5.16, trainees will not be permitted to work at less than the predetermined rate for the work performed unless they are employed pursuant to and individually registered in a program which has received prior approval, evidenced by formal certification by the U.S. Department of Labor, Employment and Training Administration. The ratio of trainees to journeymen on the job site shall not be greater than permitted under

the plan approved by the Employment and Training Administration. Every trainee must be paid at not less than the rate specified in the approved program for the trainee's level of progress, expressed as a percentage of the journeyman hourly rate specified in the applicable wage determination. Trainees shall be paid fringe benefits in accordance with the provisions of the trainee program. If the trainee program does not mention fringe benefits, trainees shall be paid the full amount of fringe benefits listed in the wage determination unless the Administrator of the Wage and Hour Division determines that there is an apprenticeship program associated with the corresponding journeyman wage rate in the wage determination which provides for less than full fringe benefits for apprentices. Any employee listed on the payroll at a trainee rate who is not registered and participating in a training plan approved by the Employment and Training Administration shall be paid not less than the applicable wage rate in the wage determination for the classification of work actually performed. In addition, any trainee performing work on the job site in excess of the ratio permitted under the registered program shall be paid not less than the applicable wage rate in the wage determination for the work actually performed. In the event the Employment and Training Administration withdraws approval of a training program, the Contractor will no longer be permitted to utilize trainees at less than the applicable predetermined rate for the work performed until an acceptable program is approved.

- (3) Equal employment opportunity. The utilization of apprentices, trainees, and journeymen under this clause shall be in conformity with the equal employment opportunity requirements of Executive Order 11246, as amended, and 29 CFR Part 30.
- (e) Compliance with Copeland Act requirements. The Contractor shall comply with the requirements of 29 CFR Part 3, which are hereby incorporated by reference in this contract.
- (f) Contract termination; debarment. A breach of this contract clause may be grounds for termination of the contract and for debarment as a Contractor and a subcontractor as provided in 29 CFR 5.12.
- (g) Compliance with Davis-Bacon and related Act requirements. All rulings and interpretations of the Davis-Bacon and related Acts contained in 29 CFR Parts 1, 3, and 5 are herein incorporated by reference in this contract.
- (h) Disputes concerning labor standards. Disputes arising out of the labor standards provisions of this clause shall not be subject to the general disputes clause of this contract. Such disputes shall be resolved in accordance with the procedures of the Department of Labor set forth in 29 CFR Parts 5, 6, and 7. Disputes within the meaning of this clause include disputes between the Contractor (or any of its subcontractors) and the PHA, HUD, the U.S. Department of Labor, or the employees or their representatives.
- (i) Certification of eligibility.
 - (1) By entering into this contract, the Contractor certifies that neither it (nor he or she) nor any person or firm who has an interest in the Contractor's firm is a person or firm ineligible to be awarded contracts by the United States Government by virtue of section 3(a) of the Davis-Bacon Act or 29 CFR 5.12(a)(1).

- (2) No part of this contract shall be subcontracted to any person or firm ineligible for award of a United States Government contract by virtue of section 3(a) of the Davis-Bacon Act or 29 CFR 5.12(a)(1).
 - (3) The penalty for making false statements is prescribed in the U. S. Criminal Code, 18 U.S.C. 1001.
- (j) Contract Work Hours and Safety Standards Act. As used in this paragraph, the terms "laborers" and "mechanics" include watchmen and guards.
- (1) Overtime requirements. No contractor or subcontractor contracting for any part of the contract work which may require or involve the employment of laborers or mechanics, including watchmen and guards, shall require or permit any such laborer or mechanic in any workweek in which the individual is employed on such work to work in excess of 40 hours in such workweek unless such laborer or mechanic receives compensation at a rate not less than one and one-half times the basic rate of pay for all hours worked in excess of 40 hours in such workweek.
 - (2) Violation; liability for unpaid wages; liquidated damages. In the event of any violation of the provisions set forth in subparagraph (j)(1) of this clause, the Contractor and any subcontractor responsible therefor shall be liable for the unpaid wages. In addition, such Contractor and subcontractor shall be liable to the United States (in the case of work done under contract for the District of Columbia or a territory, to such District or to such territory), for liquidated damages. Such liquidated damages shall be computed with respect to each individual laborer or mechanic (including watchmen and guards) employed in violation of the provisions set forth in subparagraph (j)(1) of this clause, in the sum of \$10 for each calendar day on which such individual was required or permitted to work in excess of the standard workweek of 40 hours without payment of the overtime wages required by provisions set forth in subparagraph (j)(1) of this clause.
 - (3) Withholding for unpaid wages and liquidated damages. HUD or its designee shall upon its own action or upon written request of an authorized representative of the Department of Labor withhold or cause to be withheld, from any moneys payable on account of work performed by the Contractor or subcontractor under any such contract or any Federal contract with the same prime Contractor, or any other Federally-assisted contract subject to the Contract Work Hours and Safety Standards Act, which is held by the same prime Contractor, such sums as may be determined to be necessary to satisfy any liabilities of such Contractor or subcontractor for unpaid wages and liquidated damages as provided in the provisions set forth in subparagraph (j)(2) of this clause.
- (k) Subcontracts. The Contractor or subcontractor shall insert in any subcontracts all the provisions contained in this clause, and such other clauses as HUD or its designee may by appropriate instructions require, and also a clause requiring the subcontractors to include these provisions in any lower tier subcontracts. The prime Contractor shall be responsible for the compliance by any subcontractor or lower tier subcontractor with all these provisions.

47. Non-Federal Prevailing Wage Rates

- (a) Any prevailing wage rate (including basic hourly rate and any fringe benefits), determined under State or tribal law to be prevailing, with respect to any employee in any trade or position employed under the contract, is inapplicable to the contract and shall not be enforced against the Contractor or any subcontractor, with respect to employees engaged under the contract whenever such non-Federal prevailing wage rate exceeds:
 - (1) The applicable wage rate determined by the Secretary of Labor pursuant to the Davis-Bacon Act (40 U.S.C. 3141 et seq.) to be prevailing in the locality with respect to such trade;
- (b) An applicable apprentice wage rate based thereon specified in an apprenticeship program registered with the U.S. Department of Labor (DOL) or a DOL-recognized State Apprenticeship Agency; or
- (c) An applicable trainee wage rate based thereon specified in a DOL-certified trainee program.

48. Procurement of Recovered Materials.

- (a) In accordance with Section 6002 of the Solid Waste Disposal Act, as amended by the Resource Conservation and Recovery Act, the Contractor shall procure items designated in guidelines of the Environmental Protection Agency (EPA) at 40 CFR Part 247 that contain the highest percentage of recovered materials practicable, consistent with maintaining a satisfactory level of competition. The Contractor shall procure items designated in the EPA guidelines that contain the highest percentage of recovered materials practicable unless the Contractor determines that such items: (1) are not reasonably available in a reasonable period of time; (2) fail to meet reasonable performance standards, which shall be determined on the basis of the guidelines of the National Institute of Standards and Technology, if applicable to the item; or (3) are only available at an unreasonable price.
- (b) Paragraph (a) of this clause shall apply to items purchased under this contract where: (1) the Contractor purchases in excess of \$10,000 of the item under this contract; or (2) during the preceding Federal fiscal year, the Contractor: (i) purchased any amount of the items for use under a contract that was funded with Federal appropriations and was with a Federal agency or a State agency or agency of a political subdivision of a State; and (ii) purchased a total of in excess of \$10,000 of the item both under and outside that contract.

CONFLICT OF INTEREST QUESTIONNAIRE
For vendor doing business with local governmental entity

FORM CIQ

This questionnaire reflects changes made to the law by H.B. 23, 84th Leg., Regular Session.

This questionnaire is being filed in accordance with Chapter 176, Local Government Code, by a vendor who has a business relationship as defined by Section 176.001(1-a) with a local governmental entity and the vendor meets requirements under Section 176.006(a).

By law this questionnaire must be filed with the records administrator of the local governmental entity not later than the 7th business day after the date the vendor becomes aware of facts that require the statement to be filed. See Section 176.006(a-1), Local Government Code.

A vendor commits an offense if the vendor knowingly violates Section 176.006, Local Government Code. An offense under this section is a misdemeanor.

OFFICE USE ONLY

Date Received

1 Name of vendor who has a business relationship with local governmental entity.

2 **Check this box if you are filing an update to a previously filed questionnaire.** (The law requires that you file an updated completed questionnaire with the appropriate filing authority not later than the 7th business day after the date on which you became aware that the originally filed questionnaire was incomplete or inaccurate.)

3 Name of local government officer about whom the information is being disclosed.

Name of Officer

4 Describe each employment or other business relationship with the local government officer, or a family member of the officer, as described by Section 176.003(a)(2)(A). Also describe any family relationship with the local government officer. Complete subparts A and B for each employment or business relationship described. Attach additional pages to this Form CIQ as necessary.

A. Is the local government officer or a family member of the officer receiving or likely to receive taxable income, other than investment income, from the vendor?

Yes No

B. Is the vendor receiving or likely to receive taxable income, other than investment income, from or at the direction of the local government officer or a family member of the officer AND the taxable income is not received from the local governmental entity?

Yes No

5 Describe each employment or business relationship that the vendor named in Section 1 maintains with a corporation or other business entity with respect to which the local government officer serves as an officer or director, or holds an ownership interest of one percent or more.

6 Check this box if the vendor has given the local government officer or a family member of the officer one or more gifts as described in Section 176.003(a)(2)(B), excluding gifts described in Section 176.003(a-1).

7

Signature of vendor doing business with the governmental entity

Date

CONFLICT OF INTEREST QUESTIONNAIRE

For vendor doing business with local governmental entity

A complete copy of Chapter 176 of the Local Government Code may be found at <http://www.statutes.legis.state.tx.us/Docs/LG/htm/LG.176.htm>. For easy reference, below are some of the sections cited on this form.

Local Government Code § 176.001(1-a): "Business relationship" means a connection between two or more parties based on commercial activity of one of the parties. The term does not include a connection based on:

- (A) a transaction that is subject to rate or fee regulation by a federal, state, or local governmental entity or an agency of a federal, state, or local governmental entity;
- (B) a transaction conducted at a price and subject to terms available to the public; or
- (C) a purchase or lease of goods or services from a person that is chartered by a state or federal agency and that is subject to regular examination by, and reporting to, that agency.

Local Government Code § 176.003(a)(2)(A) and (B):

(a) A local government officer shall file a conflicts disclosure statement with respect to a vendor if:

(2) the vendor:

(A) has an employment or other business relationship with the local government officer or a family member of the officer that results in the officer or family member receiving taxable income, other than investment income, that exceeds \$2,500 during the 12-month period preceding the date that the officer becomes aware that

- (i) a contract between the local governmental entity and vendor has been executed;
- or
- (ii) the local governmental entity is considering entering into a contract with the vendor;

(B) has given to the local government officer or a family member of the officer one or more gifts that have an aggregate value of more than \$100 in the 12-month period preceding the date the officer becomes aware that:

- (i) a contract between the local governmental entity and vendor has been executed; or
- (ii) the local governmental entity is considering entering into a contract with the vendor.

Local Government Code § 176.006(a) and (a-1)

(a) A vendor shall file a completed conflict of interest questionnaire if the vendor has a business relationship with a local governmental entity and:

- (1) has an employment or other business relationship with a local government officer of that local governmental entity, or a family member of the officer, described by Section 176.003(a)(2)(A);
- (2) has given a local government officer of that local governmental entity, or a family member of the officer, one or more gifts with the aggregate value specified by Section 176.003(a)(2)(B), excluding any gift described by Section 176.003(a-1); or
- (3) has a family relationship with a local government officer of that local governmental entity.

(a-1) The completed conflict of interest questionnaire must be filed with the appropriate records administrator not later than the seventh business day after the later of:

(1) the date that the vendor:

- (A) begins discussions or negotiations to enter into a contract with the local governmental entity; or
- (B) submits to the local governmental entity an application, response to a request for proposals or bids, correspondence, or another writing related to a potential contract with the local governmental entity; or

(2) the date the vendor becomes aware:

- (A) of an employment or other business relationship with a local government officer, or a family member of the officer, described by Subsection (a);
- (B) that the vendor has given one or more gifts described by Subsection (a); or
- (C) of a family relationship with a local government officer.

CERTIFICATE OF INTERESTED PARTIES

FORM 1295

OFFICE USE ONLY

Complete Nos. 1 - 4 and 6 if there are interested parties.
 Complete Nos. 1, 2, 3, 5, and 6 if there are no interested parties.

1 Name of business entity filing form, and the city, state and country of the business entity's place of business.

2 Name of governmental entity or state agency that is a party to the contract for which the form is being filed.

3 Provide the identification number used by the governmental entity or state agency to track or identify the contract, and provide a description of the goods or services to be provided under the contract.

4 Name of Interested Party	City, State, Country (place of business)	Nature of Interest (check applicable)	
		Controlling	Intermediary
DO NOT COMPLETE AT THIS TIME. TO BE COMPLETED BY		AWARDED CONTRACTOR ONLY.	

5 Check only if there is NO Interested Party.

6 AFFIDAVIT I swear, or affirm, under penalty of perjury, that the above disclosure is true and correct.

 Signature of authorized agent of contracting business entity

AFFIX NOTARY STAMP / SEAL ABOVE

Sworn to and subscribed before me, by the said _____, this the _____ day of _____, 20 _____, to certify which, witness my hand and seal of office.

 Signature of officer administering oath Printed name of officer administering oath Title of officer administering oath

ADD ADDITIONAL PAGES AS NECESSARY

DISCLOSURE OF LOBBYING ACTIVITIES

Complete this form to disclose lobbying activities pursuant to 31 U.S.C. 1352

Approved by OMB

0348-0046

(See reverse for public burden disclosure.)

1. Type of Federal Action: <input type="checkbox"/> a. contract <input type="checkbox"/> b. grant <input type="checkbox"/> c. cooperative agreement <input type="checkbox"/> d. loan <input type="checkbox"/> e. loan guarantee <input type="checkbox"/> f. loan insurance	2. Status of Federal Action: <input type="checkbox"/> a. bid/offer/application <input type="checkbox"/> b. initial award <input type="checkbox"/> c. post-award	3. Report Type: <input type="checkbox"/> a. initial filing <input type="checkbox"/> b. material change For Material Change Only: year _____ quarter _____ date of last report _____
4. Name and Address of Reporting Entity: <input type="checkbox"/> Prime <input type="checkbox"/> Subawardee Tier _____, <i>if known</i> : Congressional District, if known:	5. If Reporting Entity in No. 4 is a Subawardee, Enter Name and Address of Prime: Congressional District, if known:	
6. Federal Department/Agency:	7. Federal Program Name/Description: CFDA Number, <i>if applicable</i> : _____	
8. Federal Action Number, if known:	9. Award Amount, if known: \$ _____	
10. a. Name and Address of Lobbying Registrant <i>(if individual, last name, first name, MI):</i>	b. Individuals Performing Services <i>(including address if different from No. 10a)</i> <i>(last name, first name, MI):</i>	
11. Information requested through this form is authorized by title 31 U.S.C. section 1352. This disclosure of lobbying activities is a material representation of fact upon which reliance was placed by the tier above when this transaction was made or entered into. This disclosure is required pursuant to 31 U.S.C. 1352. This information will be available for public inspection. Any person who fails to file the required disclosure shall be subject to a civil penalty of not less than \$10,000 and not more than \$100,000 for each such failure.	Signature: _____ Print Name: _____ Title: _____ Telephone No.: _____ Date: _____	
Federal Use Only:		Authorized for Local Reproduction Standard Form LLL (Rev. 7-97)

INSTRUCTIONS FOR COMPLETION OF SF-LLL, DISCLOSURE OF LOBBYING ACTIVITIES

This disclosure form shall be completed by the reporting entity, whether subawardee or prime Federal recipient, at the initiation or receipt of a covered Federal action, or a material change to a previous filing, pursuant to title 31 U.S.C. section 1352. The filing of a form is required for each payment or agreement to make payment to any lobbying entity for influencing or attempting to influence an officer or employee of any agency, a Member of Congress, an officer or employee of Congress, or an employee of a Member of Congress in connection with a covered Federal action. Complete all items that apply for both the initial filing and material change report. Refer to the implementing guidance published by the Office of Management and Budget for additional information.

1. Identify the type of covered Federal action for which lobbying activity is and/or has been secured to influence the outcome of a covered Federal action.
2. Identify the status of the covered Federal action.
3. Identify the appropriate classification of this report. If this is a followup report caused by a material change to the information previously reported, enter the year and quarter in which the change occurred. Enter the date of the last previously submitted report by this reporting entity for this covered Federal action.
4. Enter the full name, address, city, State and zip code of the reporting entity. Include Congressional District, if known. Check the appropriate classification of the reporting entity that designates if it is, or expects to be, a prime or subaward recipient. Identify the tier of the subawardee, e.g., the first subawardee of the prime is the 1st tier. Subawards include but are not limited to subcontracts, subgrants and contract awards under grants.
5. If the organization filing the report in item 4 checks "Subawardee," then enter the full name, address, city, State and zip code of the prime Federal recipient. Include Congressional District, if known.
6. Enter the name of the Federal agency making the award or loan commitment. Include at least one organizational level below agency name, if known. For example, Department of Transportation, United States Coast Guard.
7. Enter the Federal program name or description for the covered Federal action (item 1). If known, enter the full Catalog of Federal Domestic Assistance (CFDA) number for grants, cooperative agreements, loans, and loan commitments.
8. Enter the most appropriate Federal identifying number available for the Federal action identified in item 1 (e.g., Request for Proposal (RFP) number; Invitation for Bid (IFB) number; grant announcement number; the contract, grant, or loan award number; the application/proposal control number assigned by the Federal agency). Include prefixes, e.g., "RFP-DE-90-001."
9. For a covered Federal action where there has been an award or loan commitment by the Federal agency, enter the Federal amount of the award/loan commitment for the prime entity identified in item 4 or 5.
10. (a) Enter the full name, address, city, State and zip code of the lobbying registrant under the Lobbying Disclosure Act of 1995 engaged by the reporting entity identified in item 4 to influence the covered Federal action.

(b) Enter the full names of the individual(s) performing services, and include full address if different from 10 (a). Enter Last Name, First Name, and Middle Initial (MI).
11. The certifying official shall sign and date the form, print his/her name, title, and telephone number.

According to the Paperwork Reduction Act, as amended, no persons are required to respond to a collection of information unless it displays a valid OMB Control Number. The valid OMB control number for this information collection is OMB No. 0348-0046. Public reporting burden for this collection of information is estimated to average 10 minutes per response, including time for reviewing instructions, searching existing data sources, gathering and maintaining the data needed, and completing and reviewing the collection of information. Send comments regarding the burden estimate or any other aspect of this collection of information, including suggestions for reducing this burden, to the Office of Management and Budget, Paperwork Reduction Project (0348-0046), Washington, DC 20503.

Certification of Payments to Influence Federal Transactions

U.S. Department of Housing and Urban Development
Office of Public and Indian Housing

OMB Approval No. 2577-0157 (Exp. 01/31/2017)

Applicant Name

Program/Activity Receiving Federal Grant Funding

The undersigned certifies, to the best of his or her knowledge and belief, that:

(1) No Federal appropriated funds have been paid or will be paid, by or on behalf of the undersigned, to any person for influencing or attempting to influence an officer or employee of an agency, a Member of Congress, an officer or employee of Congress, or an employee of a Member of Congress in connection with the awarding of any Federal contract, the making of any Federal grant, the making of any Federal loan, the entering into of any cooperative agreement, and the extension, continuation, renewal, amendment, or modification of any Federal contract, grant, loan, or cooperative agreement.

(2) If any funds other than Federal appropriated funds have been paid or will be paid to any person for influencing or attempting to influence an officer or employee of an agency, a Member of Congress, an officer or employee of Congress, or an employee of a Member of Congress in connection with this Federal contract, grant, loan, or cooperative agreement, the undersigned shall complete and submit Standard Form-LLL, Disclosure Form to Report Lobbying, in accordance with its instructions.

(3) The undersigned shall require that the language of this certification be included in the award documents for all subawards at all tiers (including subcontracts, subgrants, and contracts under grants, loans, and cooperative agreements) and that all sub recipients shall certify and disclose accordingly.

This certification is a material representation of fact upon which reliance was placed when this transaction was made or entered into. Submission of this certification is a prerequisite for making or entering into this transaction imposed by Section 1352, Title 31, U.S. Code. Any person who fails to file the required certification shall be subject to a civil penalty of not less than \$10,000 and not more than \$100,000 for each such failure.

I hereby certify that all the information stated herein, as well as any information provided in the accompaniment herewith, is true and accurate.

Warning: HUD will prosecute false claims and statements. Conviction may result in criminal and/or civil penalties. (18 U.S.C. 1001, 1010, 1012; 31 U.S.C. 3729, 3802)

Name of Authorized Official

Title

Signature

Date (mm/dd/yyyy)

ATTACHMENT C
Profile of Firm Form
Company Biography

PROFILE OF FIRM FORM (Page 1 of 2)

(1) Prime ___ Joint Venture/Partner ___ Sub-contractor ___ (This form shall be completed by and for each).

(2) Legal Name of Firm: _____ Telephone: _____ Fax: _____
 dba if applicable: _____

(3) Street Address, City, State, Zip: _____

(4) Identify Principals/Partners in Firm

NAME	TITLE	% OF OWNERSHIP

(5) Please indicate the operating structure of your company.

- Publicly Held Corporation
 Privately Held Corporation
 Government Agency
 Non-Profit Organization
 Partnership
 Sole Proprietorship

(6) Bidder's Diversity Statement: You must check all of the following that apply to the ownership of this firm and enter where provided the correct percentage (%) of ownership of each:

{Minority (MBE), or Woman-Owned (WBE) Business Enterprises qualify by virtue of 51% or more ownership and active management in the firm.}

- African American _____%
 Native American _____%
 Hispanic American _____%
 Asian/Pacific American _____%
 Hasidic Jew _____%
 Asian/Indian American _____%

- Woman-Owned (MBE) _____%
 Woman-Owned (Caucasian) _____%
 Disabled Veteran _____%
 Caucasian American (Male) _____%
 Other (Specify): _____%

(7) Is the business 51% or more owned by a public housing resident? ___ Yes ___ No. If yes, provide name and address of the public housing facility:

Facility Name: _____

Facility Address: _____ City: _____

SWMBE Certification Number: _____

Certification Agency: _____

(NOTE: A CERTIFICATION/NUMBER IS NOT REQUIRED – ENTER IF AVAILABLE)

(8) Federal Tax ID Number: _____

(9) City of San Antonio Business License No.: _____

(10) State of Texas License Type and No.: _____

PROFILE OF FIRM FORM (Page 2 of 2)

(11) Has your firm or any member of your firm been a party to litigation with a public entity? If yes, when, with whom and state the circumstances and any resolution.

(12) Has your firm or any member of your firm ever sued or been sued by the San Antonio Housing Authority or its affiliated entities? If yes, when and state the circumstances and any resolution of the lawsuit.

(13) Has your firm or any member of your firm ever had a claim brought against because of breach of contract or nonperformance? If yes, when and state the circumstances and any resolution of the matter.

(14) Debarred Statement: Has this firm, or any principal(s) ever been debarred from providing any services by the Federal Government, any state government, the State of Texas, or any local government agency within or without the State of Texas? Yes No

Initials _____

If "Yes," please attach a full detailed explanation, including dates, circumstances and current status.

(15) Disclosure Statement: Does this firm or any principals thereof have any current, past personal or professional relationship with any Commissioner or Officer of SAHA? Yes No

Initials _____

If "Yes," please attach a full detailed explanation, including dates, circumstances and current status.

(16) Verification Statement: The undersigned Offerer hereby states that by completing and submitting this form he/she is verifying that all information provided herein is, to the best of his/her knowledge, true and accurate, and agrees that if the SAHA discovers that any information entered herein is false, that shall entitle the SAHA to not consider nor make award or to cancel any award with the undersigned party.

Initials _____

(18) In performing this contract, the contractor(s) shall comply with any and all applicable federal, state or local laws including but not limited to: Occupational Safety & Health, Equal Employment Opportunity, Immigration and Naturalization, The Americans with Disabilities Act, State Tax and Insurance Law, and the Fair Housing Act.

Initials _____

Signature

Date

Printed Name

Company

Company Biography

Company Name: _____

Headquarters Location: _____

Field Office Locations: _____

Business Specialty or Focus: _____

Number of Full Time Staff: _____

Founding Date and Brief History: _____

Texas Projects and/or Clients: _____

(past & current)

Previous Housing Authority Experience: YES NO

List the Authorities: _____

Proposed Subcontractors

Note: A completed Profile of Firm Form must be submitted for each subcontractor.

Proposed Subcontractors					
Item	Company Name	Address	Phone	Specialty	S/W/M/V BE
1					
2					
3					
4					
5					
6					
7					
8					
9					
10					
11					
12					
13					
14					
15					
16					
17					
18					
19					
20					

<p>I understand and agree that if awarded a contract as a result of this solicitation that the use of the above subcontractors is subject to the approval of SAHA and becomes a part of the contract. I further understand that any change in subcontractors also requires the pre-approval of SAHA.</p>	<p>_____</p> <p>(Signature)</p> <p>_____</p> <p>(Printed Name & Title)</p> <p>_____</p> <p>(Company Name)</p>
----------------------------------------------------------------------------------------------------------------------------------------------------------------------------------------------------------------------------------------------------------------------------------------------------------	-------------------------------------------------------------------------------------------------------------------

ATTACHMENT D
Section 3 Guidelines and Forms

SAN ANTONIO HOUSING AUTHORITY

SECTION 3 PROGRAM

CONTRACTOR COMPLIANCE GUIDE

BACKGROUND

The San Antonio Housing Authority (SAHA) adopted a formal Section 3 program, policy, and procedures on June 2, 2011 (Resolution 5164) to provide the framework for its compliance with Section 3 of the Housing and Urban Development (HUD) Act of 1968 which applies to all employment and economic projects funded in whole or in part by HUD.

Therefore, all prime contractors participating on a HUD-assisted project shall comply with all applicable sections of the SAHA Section 3 Program.

The objective of the SAHA Section 3 Program is to ensure to the greatest extent feasible that employment and other economic-related opportunities are directed to low- and very-low income individuals and businesses owned by such individuals.

SECTION 3 GUIDANCE

1. The SAHA Section 3 Program adopted on June 2, 2011 is hereby incorporated by reference as part of this Interim Section 3 Guidance. Notice is hereby given that it is the responsibility of bidder/proposer or contractor to ensure understanding and compliance with all applicable sections of the Section 3 Program. Bidders/proposers and/or prime contractors are directed to the SAHA website for more information on the Section 3 Program.
2. The Section 3 Program requirements apply to all HUD-assisted projects covered by Section 3 and are therefore applicable to SAHA bidders/proposers and recipients of contracts and subcontracts.
3. In order to achieve the Section 3 Program objectives, numerical goals for training/employment and subcontracting opportunities for Section 3 residents and Business Concerns have been established. The Section 3 goals (below) apply to the entire Section 3 covered project and represent minimum numerical goals set forth in the Section 3 Program. In the absence of evidence to the contrary, a contractor that meets the minimum numerical goals will be considered to have complied with the Section 3 Program requirements. SAHA reserves the right to increase project-specific goals as may be deemed appropriate by the SAHA representatives. Contractors are advised to read each solicitation carefully to determine the applicable goals for compliance. In the event the solicitation changes the goals listed below, Contractor must follow the stricter goals.

Employment: Thirty percent (30%) of new hires per contract should be Section 3 residents.

Contracting: Subcontract ten percent (10%) of the total value of a construction contract with Section 3 Business Concerns.

Professional Services: Subcontract three percent (3%) with Section 3 Business Concerns on non-construction contracts (professional services).

3. In order to ensure the greatest impact on employment, contracting and economic opportunities, SAHA contractors and subcontractors shall direct their efforts to Section 3 residents and Business Concerns on a “preference” tiered basis as follows:

Training/Employment

- a) Category 1: Residents of the housing development or developments for which the Section 3 covered assistance is expended.
- b) Category 2: Residents of the other housing developments managed by the housing authority that is expending the Section 3 covered assistance.
- c) Category 3: Participants in HUD Youthbuild programs being carried out in the metropolitan area in which the Section 3 covered assistance is expended.
- d) Other Section 3 residents.

Contracting Opportunities

- a) Category 1: Business Concerns that are 51 percent or more owned by residents of the housing development or developments for which the Section 3 covered assistance is expended, or whose full-time permanent workforce includes 30 percent of those persons as employees.
- b) Category 2: Business Concerns that are 51 percent or more owned by residents of other housing developments or developments managed by the housing authority that is expending the Section 3 covered assistance, or whose full-time permanent workforce includes 30 percent of those persons as employees.
- c) Category 3: HUD Youthbuild programs being carried out in the metropolitan area (or non-metropolitan county) in which the Section 3 covered assistance is expended.
- d) Category 4: Business concerns that are 51 percent or more owned by Section 3 residents or whose permanent, full-time workforce includes no less than 30 percent Section 3 residents, or that subcontract in excess of 25 percent of the total amount of subcontracts to Category 1 or 2 business concerns identified above.

4. To more effectively apply the Section 3 preferences, the following incentives shall be applicable to Section 3 HUD-assisted projects:

Solicitations Under \$50,000

On solicitations under \$50,000 and where two or more certified Section 3 Business Concerns are available to compete, SAHA will institute a “first source” solicitation initiative whereby two of the three solicited firms must be Section 3 Business Concerns.

Solicitations Greater than \$50,000

On Requests for Proposals the following incentives will be instituted:

- 1) A twenty percent (20%) preference will be instituted for Category 1 Section 3 Business Concerns bidding as prime contractors.
- 2) A fifteen percent (15%) preference will be instituted for Category 2 Section 3 Business Concerns bidding as prime contractors.
- 3) A ten percent (10%) preference will be instituted for Category 3 Section 3 Business Concerns bidding as prime contractors.
- 4) A five percent (5%) preference will be instituted for Category 4 Section 3 Business Concerns bidding as prime contractors.
- 5) A five percent (5%) preference will be provided to SAHA prime contractors that have achieved both the resident hires and business concern contracting goals in their immediate past contract performance within the last year.
- 6) A five percent (5%) preference will be provided to SAHA prime contractors participating in a SAHA approved Joint Venture or Mentor-Protégé program with an eligible Section 3 Business Concern.
- 7) A five percent (5%) preference will be provided to prime contractors that have formal apprenticeship programs approved by DOL and commit to training no less than ten (10) eligible Section 3 residents through such programs annually that provide no less than 250 hours of formal training.

On Invitations for Bids the following preference will be instituted:

- 1). Contractors who are certified as Section 3 Business Concerns and whose prices are within the independent cost estimate of the project and are both responsive and responsible, shall receive a preference according to the following table, where x is the amount by which the Section 3 Business Concern may be above the lowest responsive bid.

 x=lesser of:

When the lowest responsive bid
 is less than \$100,000 10% of that bid or \$9,000.

When the lowest responsive bid is:
 At least \$100,000, but less than \$200,000 9% of that bid, or \$16,000.
 At least \$200,000, but less than \$300,000 8% of that bid, or \$21,000.
 At least \$300,000, but less than \$400,000 7% of that bid, or \$24,000.

At least \$400,000, but less than \$500,000 6% of that bid, or \$25,000.
At least \$500,000, but less than \$1 million 5% of that bid, or \$40,000.
At least \$1 million, but less than \$2 million 4% of that bid, or \$60,000.
At least \$2 million, but less than \$4 million 3% of that bid, or \$80,000.
At least \$4 million, but less than \$7 million 2% of that bid, or \$105,000.
\$7 million or more 1½% of the lowest responsive bid, with no dollar limit.

2) Where two or more Section 3 business concerns are both responsive and responsible, the Section 3 business concern with the lowest price shall receive the contract award.

A successful contractor's usage of the above preferences shall be capped annually at \$1 million dollars in the aggregate. Once a contractor has been awarded annually \$1 million dollars in contracts as a result of a preference, the contractor is no longer eligible for the above preferences for the remainder of the calendar year.

5. Bidders/proposers must either achieve the Section 3 Program employment and subcontracting goals identified above (under number 3) or demonstrate acceptable good faith efforts to achieve the numerical goals in the proposal/bid. SAHA representatives shall review and deem acceptable, in their sole determination, a bidder or proposer's good faith efforts prior to the award of the contract. Please be advised that a contractor Section 3 performance will be considered and evaluated on future SAHA contracts and will be a factor in the selection and/or contract award.
6. To ensure that the SAHA Section 3 Program benefits individuals and businesses that are eligible Section 3 residents and Business Concerns, all Section 3 resident and Business Concerns must be deemed eligible through documentation of a "Section 3 Eligibility Form" for each eligible individual or business. Notice is hereby given that it is the responsibility of the prime contractor to ensure that all participating and eligible Section 3 residents and/or Business Concerns (vendors, suppliers or subcontractors) submit the necessary information for proper SAHA status review and credit.
7. All SAHA prime contractors must submit a Section 3 program compliance report on a monthly basis in the form and content as requested by SAHA staff. This report shall document Section 3 resident and Business Concern training, employment, and subcontracting monthly performance against goals and opportunities.
8. Failure or refusal by a SAHA bidder/proposer or contractor to satisfy or comply with the Section 3 Program requirements, either during the bid/proposal process or during the term of the SAHA agreement, shall constitute a material breach of contract whereupon the contract, at the option of SAHA, may be cancelled, terminated, or suspended in whole or in part; and, the contractor debarred from further contracts with SAHA as a non-responsible contractor. SAHA may at its discretion also declare bids/proposals not complying with the Section 3 Program requirements in whole or in part nonresponsive and eliminate them from consideration of a contract award.

INTERIM PRIME CONTRACTOR COMPLIANCE REQUIREMENTS

Prime contractors participating on SAHA Section 3 HUD-assisted projects are specifically required to address and satisfy the Section 3 Program requirements described below *prior* to the award of the contract. The Section 3 Program requirements shall be applicable throughout the duration of the contract and to any amendment and renewal.

1. In the absence of evidence to the contrary, a prime contractor that meets the minimum Section 3 Program numerical goals set forth in the solicitation will be considered to have complied with the Section 3 Program requirements. A prime contractor who meets this goal must submit with the bid/proposal a “*Good Faith Effort Compliance Plan*” (**Attachment A**) by simply completing Sections A and B which present the project and contractor information and goal commitment information respectfully.
2. In evaluating compliance, a prime contractor that *has not* met the numerical goals set forth in the solicitation has the burden of fully demonstrating its efforts to achieve the Section 3 goals through the submittal and approval of a “*Good Faith Effort Compliance Plan*” (**Attachment A**) to include completion of Sections A, B and C which must be included with the bid/proposal. SAHA representatives shall review and determine in their sole discretion whether a bidder or proposer’s (contractor) good faith effort compliance plan achieves the Section 3 Program goals and objectives. A responsive good faith effort compliance plan shall address all questions in Sections A, B and C and describe the concrete efforts that were taken and will be taken to reach numerical goals in hiring/employment, training, and contracting. The final agreed-upon plan shall become part of the SAHA contract.
3. SAHA reserves the right to disregard bids/proposals as non-responsive bids and proposals which fail to demonstrate a good faith effort towards compliance with the Section 3 Program requirements.
4. As required under the Section 3 Program’s contractual clause, prime contractors specifically agree to include the Section 3 Clause in every subcontract subject to compliance with regulations in 24 CFR Part 135, and agree to take appropriate action, as provided in an applicable provision of the subcontract or in the Section 3 Clause, upon a finding that a subcontractor is in violation of the regulations in 24 CFR Part 135. A prime contractor shall not subcontract with any subcontractor where the bidder/proposer has notice or knowledge that the subcontractor has been found in violation of the regulations in 24 CFR Part 135.
5. Prime contractors shall submit a properly completed and executed “Section 3 Eligibility Form” for all participating Section 3 residents and/or Section 3 Business Concerns (**Attachment B**). It is the responsibility of the prime contractor to ensure that eligible Section 3 residents and Business Concerns submit all necessary information for SAHA review and credit, to include an eligible Section 3 prime contractor, if applicable.

6. Prime contractors requesting a Section 3 Program preference based upon employment or ownership interest shall submit a properly completed and executed Section 3 Eligibility Forms for all employees and owners who qualify, and provide any supporting documentation that may subsequently be required by SAHA. Prime contractors and subcontractors must employ any Section 3 residents full-time for not less than one month prior to the submittal of the bid/proposal in order for the prime contractor to receive credit for employing the Section 3 resident for a preference.
7. Notwithstanding the fact that a prime contractor may have the capability to complete a total project with its own workforce and without the use of subcontractors, all SAHA prime contractors on a HUD-assisted project shall be required to achieve the Section 3 Program numerical goals or demonstrate a good faith effort to achieve those goals within the industry. Should the need arise to hire or subcontract during the term of a contract, the hiring and/or subcontracting goals shall still be applicable and the training component remains in force.
8. All changes to the original list of subcontractors submitted with the bid or proposal shall be submitted for review and approval in accordance with SAHA's procedures when adding, changing, or deleting subcontractors/sub-consultants. Prime contractors are required to make a good faith effort to replace any Section 3 Business Concern with another eligible Section 3 Business Concern. SAHA may deny such requests when it finds that a prime contractor fails to provide acceptable justification or when the effect of such change would dilute a preference received on a HUD-assisted contract.
9. All prime contractors participating on a HUD-assisted project shall submit a Section 3 Performance Report no later than the third business day of the following month detailing Section 3 employment and contracting activity not only for themselves but also all subcontractors on the project. The report is to also detail training and other economic opportunity activities by the prime contractor and subcontractors.

SAN ANTONIO HOUSING AUTHORITY SECTION 3 PROGRAM UTILIZATION PLAN

INSTRUCTION SHEET

Please read these instructions carefully before completing the required *Section 3 Utilization Plan* document. These instructions are designed to assist bidders/proposers document Section 3 Program compliance. or present a detailed explanation why, despite their best efforts the minimum numerical goals were not met. These numerical goals are **minimum** targets that must be reached in order for SAHA to consider a recipient in compliance.

Questions regarding completion of the *Section 3 Utilization Plan* document should be directed to: Section 3 Coordinator, at 210 -477 -6165 or section3@saha.org.

- Bidders/proposers are required to make sincere efforts to achieve the Section 3 Program numerical goals as specified in solicitation documents. A bidders/proposers approved Section 3 Utilization Plan will be monitored throughout the duration of the SAHA contractual term.
- Contractor shall submit a *Section 3 Utilization Plan* at the time of bid/proposal submittal in order to be considered responsive.
- This *Section 3 Utilization Plan* is subject to SAHA's review and approval. SAHA may at its sole discretion approve or disapprove the plan. SAHA's determination is administratively appealable to the CEO and to the Board of Commissioners pursuant to SAHA's Section 3 Program, Policy & Procedures.
- All bidders/proposers are to complete the following:

- _____ **Section A**, Bidder/Proposer Information
- _____ **Section B**, Contractor Commitments - New Hires
- _____ **Section C**, Contractor Commitments - Subcontractors
- _____ **Section D**, Contractor Commitments – Other Economic Opportunities
- _____ **Section E**, Good Faith Efforts
- _____ **Section F**, Section 3 Compliance Certification

Optional:

- _____ Certification for Section 3 Business Concerns
- _____ Section 3 Individual Verification Form (S3-6003b REV 2/2016)

- SAHA requires all Section 3 residents and/or Business Concerns to certify or submit evidence to SAHA, contractor, or subcontractor, that the person or business is Section 3 eligible. SAHA has developed a Certification Process for this purpose. It is the responsibility of the Contractor to submit these forms to the SAHA Section 3 Coordinator at section3@saha.org.

SECTION 3 PROGRAM UTILIZATION PLAN

Project Title: _____

SECTION A – BIDDER/PROPOSER INFORMATION

Name of Firm: _____

Contact Person: _____ Telephone: _____

Email: _____

Is your firm a "Section 3 Business Concern": Yes _____ No _____
 If "Yes"; complete the Certification for Section 3 Business Form and attach the Required Documentation.

SECTION B – CONTRACTOR COMMITMENTS – NEW HIRES (If more space is needed, please provide an attachment).

Hiring Goal: A minimum of Thirty percent (30%) of the aggregate number of new hires shall be Section 3 residents

B.1 Explain how you intend to recruit a minimum of 30% of Section 3 residents for **full-time new hires**, and what actions you will use to require subcontractors to do the same. **Note:** Section 3 individuals must work a minimum of 32 hours per week or 135 hours per month to be considered full-time employees.

B.2 Complete the table below to identify the bidder's/proposer's employee positions required for the execution of this project.

Job Category*	Number of Positions to be Filled with Section 3 Residents	Anticipated wages per hour
Professionals		
Technicians		
Office/Clerical		
Officers/Managers		
Sales		
Craft Workers (Skilled)		
Operatives (Semi-Skilled)		
Laborers (Unskilled)		
Service Workers		
Other List & describe		

B.3 The contractor has committed to employ _____ resident(s) in order to comply with its Section 3 requirements. Indicate the estimated percentage of Section 3 new hires for this project: _____

SECTION C – CONTRACTOR COMMITMENTS – SUBCONTRACTORS (If more space is needed, please provide an attachment).

Contracting Goal: A minimum of ten percent (10%) of all covered **construction** contracts shall be awarded to Section 3 business concerns. Three percent (3%) of all covered **non-construction** contracts shall be awarded to Section 3 business concerns

C.1 Describe how bids from Section 3 businesses will be solicited for subcontracting.

C.2 Complete the table below to identify the subcontractors/suppliers that will be utilized for the execution of this project.

Subcontractor/Supplier Listing

Subcontractor or Supplier/ Name and Address and phone number	Scope of Work/Product	\$ Value	Certified Section 3 Business Concern (Y/N)

(Make Additional Copies as Necessary)

C.3 The Prime Contractor will subcontract with a total of _____ Section 3 Business Concerns totaling _____% of the Contract Value. **NOTE:** *The contractual opportunity goal is a percentage of the total gross dollar value of the proposed contract awarded to a Section 3 eligible Business Concern. SAHA will only credit participation by Section 3 Business Concerns that submit documentation acceptable to SAHA certifying their Section 3 status.*

**SECTION D – CONTRACTOR COMMITMENTS – OTHER ECONOMIC OPPORTUNITIES
(If more space is needed, please provide an attachment).**

B.3 The undersigned bidder/proposer will satisfy the Section 3 *other economic opportunity* goal:
Yes _____ No _____

Please outline your plan to provide other economic opportunities to Section 3 residents. Examples of plans may include training agreements, internship programs, mentorship programs etc.

SECTION E – GOOD FAITH EFFORTS

NOTE: Fill this section only, if Plan as submitted fails to meet the employment and contractual opportunity goals as stated herein or as amended in the solicitation.

D.1 If no contracting, hiring or other economic opportunities are anticipated, briefly explain why.

SECTION F: SECTION 3 UTILIZATION PLAN CERTIFICATION

I CERTIFY THAT I HAVE REVIEWED AND FULLY UNDERSTAND SAHA'S SECTION 3 PROGRAM AND THE SECTION 3 CLAUSE INCORPORATED BY REFERENCE INTO THIS DOCUMENT. I HEREBY AFFIRM THAT THE INFORMATION SUBMITTED HEREIN IS TRUE AND COMPLETE TO THE BEST OF MY KNOWLEDGE.

I HEREBY CERTIFY THAT THE ABOVE TABLES IDENTIFY THE NUMBER OF SECTION 3 BUSINESS CONCERNS THE COMPANY WILL UTILIZE AND THE NUMBER OF SECTION 3 RESIDENTS THE COMPANY PROPOSES TO EMPLOY.

I FURTHER UNDERSTAND AND AGREE THAT, THIS DOCUMENT SHALL BE ATTACHED THERETO AND BECOME A BINDING PART OF THE SAHA CONTRACT.

NAME AND TITLE OF AUTHORIZED OFFICIAL:

SIGNATURE: _____ DATE: _____

San Antonio Housing Authority

Section 3 Individual New Hire Verification Form

NEW HIRES MUST COMPLETE THIS FORM. The Section 3 Program requires that recipients of certain HUD financial assistance, to the greatest extent feasible provide employment, training or education opportunities for low- and very-low income persons in connection with projects and activities in their neighborhood. Completion of this form helps your new employer and SAHA monitor compliance to the Section 3 program and may help in obtaining future business with the Housing Authority. Your information is kept CONFIDENTIAL and will not affect any federal subsidies you currently receive, if any.

CONTACT INFORMATION					
First Name:	Last:	M.I.:	Suffix:		
Residence Address:			City:		
State:	Zip:	County:		Phone:	
Email Address (required):				DOB:	
Date of Hire:		Company Name:			
Job Title:		Type of job:		Full-Time (32+ hours per week)	Part-Time

INCOME DISCLOSURE (CHECK ONE OPTION BELOW)

In order to be eligible as a Section 3 individual, your household income must meet the income criteria by household size. Individuals are eligible for Section 3 status if their household income is at or below 80% of Area Median Income in Bexar County during the current calendar year or be a resident of public housing or Section 8.

Option 1: I choose to disclose this information

Choose the number of individuals in your household in the chart below to determine your HUD income limit. The dollar amount below the number you indicate is your HUD income limit.

FY 2019 80% Area Median Income Limits (by Household Size)

Number of persons in household	1	2	3	4	5	6	7	8
80% of Area Median Income (FY 2019 HUD Income Limits)	\$39,800	\$45,450	\$51,150	\$56,800	\$61,350	\$65,900	\$70,450	\$75,000

YOU MUST ANSWER THE FOLLOWING QUESTIONS IF YOU ARE CLAIMING SECTION 3 ELIGIBILITY:

Is your household income at or below the HUD income limit for the current year? **Yes** **No**

If your answer is YES and you reside in Bexar County, you are a Section 3 individual, regardless of public housing status.

Are you a resident of public housing or Section 8? **Yes** **No**

If your answer is YES, you are a Section 3 individual regardless of your income.

Option 2: I choose NOT to disclose this information OR I do not qualify as a Section 3 eligible individual.

CERTIFICATION

By signing, I authorize my employer to release relevant information to the San Antonio Housing Authority (SAHA) for contract compliance purposes. I further affirm that the information on this form is to the best of my knowledge and belief true, correct, and complete.

Signature _____

DATE: _____

M/WBE UTILIZATION STATEMENT
SAN ANTONIO HOUSING AUTHORITY
M/WBE PROGRAM OFFICE

Please read these instructions carefully before completing the required Minority/Women Business Enterprise (M/WBE) Utilization Statement. These instructions are designed to assist prime contractors/consultants document M/WBE program compliance or in preparing the required detailed and complete good faith effort information.

Contractors/Consultants are required to submit detailed documentation when the contract specified M/WBE participation ranges or goals are not met. The SAHA M/WBE Program Manager will review and consider a bidder's or proposer's good faith efforts in assisting SAHA to meet its M/WBE policy and program objectives.

A. Bidders/Proposers are required to make sincere efforts in attempting to achieve the applicable SAHA M/WBE participation ranges or goals. The approved M/WBE participation ranges or goals will be monitored throughout the duration of the project;

B. All bidders/proposers are to complete Section A, Project Identification and Section B, Project M/WBE Utilization, if applicable. Should there be subcontracting/sub consulting opportunities, yet the bidder/proposer *not* achieve the project's applicable M/WBE participation range or goal, the bidder/proposer must complete all other sections of the Statement.

C. This Statement should be prepared by the company's project M/WBE Coordinator or designee. The Statement must be signed and dated by an authorized company official. The Coordinator or designee should have a working knowledge as to the project's subcontracting or sub-consulting and supplier activities (actual and anticipated). This individual shall be a key figure in directing the prime contractor's M/WBE activities.

D. The M/WBE Utilization Statement demonstrating a contractor's good faith efforts is subject to the SAHA M/WBE Program Coordinator's review and approval.

E. SAHA requires all M/WBE firms to be certified as such by an entity acceptable to SAHA for project M/WBE credit.

F. SAHA reserves the right to approve all additions or deletions of subcontractors, subconsultants, and/or major vendors. In the event that an M/WBE subcontractor, subconsultant, and/or major vendor is replaced, the contractor must make a good faith effort to involve and utilize another M/WBE subcontractor, sub consultant, and/or major vendor.

Should you have any questions or need additional information, please contact:

Charles Bode
818 S Flores
Asst. Director of Procurement
charles_bode@saha.org
210-477-6165

FOR SAHA PROCUREMENT DEPARTMENT USE ONLY

Reviewed by: _____

Date: _____

Signature of SAHA Official: _____

Recommendation: Approval: _____ Denial: _____

subject to the SAHA M/WBE Program Manager's review and approval.

M/WBE UTILIZATION STATEMENT
 SAN ANTONIO HOUSING AUTHORITY
 M/WBE PROGRAM OFFICE

SECTION A: PROJECT IDENTIFICATION

Project Number _____ Project Title _____

Contract Amount _____ Company Name _____

Project Participation Range/Goal: M/WBE ____ %

Contract Anticipated Participation Range: M/WBE ____ %

The M/WBE participation range/goal is expressed as a percentage of the total dollar amount of the prime contract awarded to M/WBEs. The goal is applicable for those areas, which the prime contractor has subcontracted, sub-consulted, and/or major supplies necessary in the performance of the contract.

SECTION B: SUBCONTRACTOR/SUB CONSULTANT/VENDOR UTILIZATION

1. List all actual *and* anticipated subcontracts, subconsultants, and/or major material purchases, include *both* M/WBE and non-M/WBE, to be utilized on the project (*use additional sheets if necessary*).

TRADE AREA	ESTIMATED AMOUNT (\$)	SUB/SUPPLIER	SUB/SUPPLIER	
			M/WBE	Yes (✓) No

2. MBE utilization in total dollars: _____ WBE utilization in total dollars: _____

3. Overall MBE utilization percentage (%): _____

4. Overall WBE utilization percentage (%): _____

5. Overall M/WBE utilization percentage (%): _____

6. Anticipated M/WBE utilization on this contract will occur:

Throughout ___ Beginning 1/3 ___ Middle 1/3 ___ Final 1/3 ___

Please Note: SAHA will credit only those M/WBEs that have been certified by an entity acceptable to SAHA. All changes, additions, or deletions occurring during the life of this contract relative to use of the listed subcontractors, sub-consultants and/or

major suppliers, M/WBE or otherwise, must be submitted to SAHA for review and approval.

If Bidder/Proposer is unable to meet the M/WBE participation range/goal, please proceed to complete Section C and submit documentation demonstrating contractual good faith efforts.

SECTION C: GOOD FAITH EFFORT

The following items are minimally considered as good faith efforts and demonstrate specific initiatives made in attempting to achieve SAHA's M/W/BE participation ranges. The bidder/proposer is not limited to these particular areas and may include other efforts deemed appropriate. Please feel free to elaborate on any question below.

Required Questions	Yes	No
1. If applicable, was your company represented at the pre-bid conference?		
2. Did your company request and obtain a copy of the certified M/WBE firms?		
3. Were M/WBE firms solicited for contract participation?		
4. Provide listing of solicited M/WBEs with whom contact was made? Please identify name of company, contact person, date, phone number and briefly describe nature of solicitation. (Include as an Attachment)		
5. Was direct contact made with SAHA's M/WBE Program Office? If yes, please identify date/person contacted and assistance sought. (Include as an Attachment)		
6. Identify all M/WBE support agencies/associations contacted for M/WBE assistance or solicitation (Minority Chamber's of Commerce, purchasing councils, contractor groups, etc.). (Please attach copies of solicitation letters of assistance and/or describe, as an Attachment to this section, the personal contact made)		
7. Were bid opportunities related to this project advertised in minority/women newspapers and trade journals? (If yes, please include a copy of the advertisement or detail the name of the publication(s), date of advertisement and describe the solicitation)		
8. Were copies of plans and specification furnished to any M/WBEs?		
9. Were subcontractors, subconsultants, and/or suppliers (if applicable) required to provide insurance or be bonded? (If yes, please detail any assistance that was provided or if they were referred, to whom)		
10. List, as an Attachment, all M/WBE bids received but rejected. Identify company name, contact person, telephone number, date, trade area, and the reason for rejecting the bid/proposal.		
11. Discuss any other effort(s) aimed at involving M/WBEs (Include as an Attachment) : (a) Identify any specific efforts to divide work, in accordance with normal industry practices, to allow maximum M/WBE participation.		

(b) Discuss joint ventures initiatives, requesting second-tier M/WBE subcontracting, etc., if any.		
(c) List all other good faith efforts employed, please elaborate.		

The undersigned acknowledges and states that all information submitted as part of this Good Faith Effort Statement is true and correct to the best of his/her knowledge. I further agree that this document shall be attached thereto and become a binding part of the SAHA contract.

Print Name

Title Date

Signature

Telephone Number

ATTACHMENT E

Wage Decision

General Decision Number: TX190011 01/04/2019 TX11

Superseded General Decision Number: TX20180021
 State: Texas Construction Type: Residential
 Counties: Bexar, Comal and Guadalupe Counties in Texas.

RESIDENTIAL CONSTRUCTION PROJECTS (consisting of single family homes and
 apartments up to and including 4 stories.)

Note: Under Executive Order (EO) 13658, an hourly minimum wage of \$10.60 for calendar year 2019 applies to all contracts subject to the Davis-Bacon Act for which the contract is awarded (and any solicitation was issued) on or after January 1, 2015. If this contract is covered by the EO, the contractor must pay all workers in any classification listed on this wage determination at least \$10.60 per hour (or the applicable wage rate listed on this wage determination, if it is higher) for all hours spent performing on the contract in calendar year 2019. If this contract is covered by the EO and a classification considered necessary for performance of work on the contract does not appear on this wage determination, the contractor must pay workers in that classification at least the wage rate determined through the conformance process set forth in 29 CFR 5.5(a)(1)(ii) (or the EO minimum wage rate, if it is higher than the conformed wage rate). The EO minimum wage rate will be adjusted annually. Please note that this EO applies to the above-mentioned types of contracts entered into by the federal government that are subject to the Davis-Bacon Act itself, but it does not apply to contracts subject only to the Davis-Bacon Related Acts, including those set forth at 29 CFR 5.1(a)(2)-(60). Additional information on contractor requirements and worker protections under the EO is available at www.dol.gov/whd/govcontracts.

Modification Number	Publication Date
0	01/04/2019

* SUTX1983-005 05/01/1983	Rates	Fringes
Air Conditioning Mechanic.....	\$ 7.25	
CARPENTER.....	\$ 7.25	
CEMENT MASON/CONCRETE FINISHER.....	\$ 7.46	
DRYWALL HANGER.....	\$ 8.73	
ELECTRICIAN.....	\$ 9.66	
IRONWORKER.....	\$ 7.25	
LABORER.....	\$ 7.25	
PAINTER (Including Drywall taping).....	\$ 8.16	
PLUMBER.....	\$ 7.70	
ROOFER, Including Built Up, Composition and Single Ply Roofs.....	\$ 7.25	

WELDERS - Receive rate prescribed for craft performing operation to which welding is incidental.

=====

Note: Executive Order (EO) 13706, Establishing Paid Sick Leave for Federal Contractors applies to all contracts subject to the Davis-Bacon Act for which the contract is awarded (and any solicitation was issued) on or after January 1, 2017. If this contract is covered by the EO, the contractor must provide employees with 1 hour of paid sick leave for every 30 hours they work, up to 56 hours of paid sick leave each year. Employees must be permitted to use paid sick leave for their own illness, injury or other health-related needs, including preventive care; to assist a family member (or person who is like family to the employee) who is ill, injured, or has other health-related needs, including preventive care; or for reasons resulting from, or to assist a family member (or person who is like family to the employee) who is a victim of, domestic violence, sexual assault, or stalking. Additional information on contractor requirements and worker protections under the EO is available at www.dol.gov/whd/govcontracts.

Unlisted classifications needed for work not included within the scope of the classifications listed may be added after award only as provided in the labor standards contract clauses (29CFR 5.5 (a) (1) (ii)).

The body of each wage determination lists the classification and wage rates that have been found to be prevailing for the cited type(s) of construction in the area covered by the wage determination. The classifications are listed in alphabetical order of "identifiers" that indicate whether the particular rate is a union rate (current union negotiated rate for local), a survey rate (weighted average rate) or a union average rate (weighted union average rate).

Union Rate Identifiers

A four letter classification abbreviation identifier enclosed in dotted lines beginning with characters other than "SU" or "UAVG" denotes that the union classification and rate were prevailing for that classification in the survey. Example: PLUM0198-005 07/01/2014. PLUM is an abbreviation identifier of the union which prevailed in the survey for this classification, which in this example would be Plumbers. 0198 indicates the local union number or district council number where applicable, i.e., Plumbers Local 0198. The next number, 005 in the example, is an internal number used in processing the wage determination. 07/01/2014 is the effective date of the most current negotiated rate, which in this example is July 1, 2014.

Union prevailing wage rates are updated to reflect all rate changes in the collective bargaining agreement (CBA) governing this classification and rate.

Survey Rate Identifiers

Classifications listed under the "SU" identifier indicate that no one rate prevailed for this classification in the survey and the published rate is derived by computing a weighted average rate based on all the rates reported in the survey for that classification. As this weighted average rate includes all rates reported in the survey, it may include both union and non-union rates. Example: SULA2012-007 5/13/2014. SU indicates the rates are survey rates based on a weighted average calculation of rates and are not majority rates. LA indicates the State of Louisiana. 2012 is the year of survey on which these classifications and rates are based. The next number, 007 in the example, is an internal number used in producing the

wage determination. 5/13/2014 indicates the survey completion date for the classifications and rates under that identifier.

Survey wage rates are not updated and remain in effect until a new survey is conducted.

Union Average Rate Identifiers

Classification(s) listed under the UAVG identifier indicate that no single majority rate prevailed for those classifications; however, 100% of the data reported for the classifications was union data. EXAMPLE: UAVG-OH-0010 08/29/2014. UAVG indicates that the rate is a weighted union average rate. OH indicates the state. The next number, 0010 in the example, is an internal number used in producing the wage determination. 08/29/2014 indicates the survey completion date for the classifications and rates under that identifier.

A UAVG rate will be updated once a year, usually in January of each year, to reflect a weighted average of the current negotiated/CBA rate of the union locals from which the rate is based.

WAGE DETERMINATION APPEALS PROCESS

1.) Has there been an initial decision in the matter? This can be:

- * an existing published wage determination
- * a survey underlying a wage determination
- * a Wage and Hour Division letter setting forth a position on a wage determination matter
- * a conformance (additional classification and rate) ruling

On survey related matters, initial contact, including requests for summaries of surveys, should be with the Wage and Hour Regional Office for the area in which the survey was conducted because those Regional Offices have responsibility for the Davis-Bacon survey program. If the response from this initial contact is not satisfactory, then the process described in 2.) and 3.) should be followed.

With regard to any other matter not yet ripe for the formal process described here, initial contact should be with the Branch of Construction Wage Determinations. Write to:

Branch of Construction Wage Determinations
Wage and Hour Division
U.S. Department of Labor
200 Constitution Avenue, N.W.
Washington, DC 20210

2.) If the answer to the question in 1.) is yes, then an interested party (those affected by the action) can request review and reconsideration from the Wage and Hour Administrator (See 29 CFR Part 1.8 and 29 CFR Part 7). Write to:

Wage and Hour Administrator
U.S. Department of Labor
200 Constitution Avenue, N.W.
Washington, DC 20210

The request should be accompanied by a full statement of the interested party's position and by any information (wage payment data, project description, area practice material, etc.) that the requestor considers relevant to the issue.

3.) If the decision of the Administrator is not favorable, an interested party may appeal directly to the Administrative Review Board (formerly the Wage Appeals Board). Write to:

Administrative Review Board
U.S. Department of Labor
200 Constitution Avenue, N.W.
Washington, DC 20210

4.) All decisions by the Administrative Review Board are final.

=====

END OF GENERAL DECISION

ATTACHMENT F
Form of Bid
Bid Fee Sheet
Bidder's Certification

FORM OF BID

(This Form must be fully completed and placed under Tab #1 of the bid submittal.)

INSTRUCTIONS: The items listed below must be completed and included in the bid unless otherwise specifically noted. Please complete this form by marking X, where provided, to indicate that the referenced information has been included. Also, complete the Section 3 Statement and the Bidder’s Statement noted on the subsequent page:

X=ITEM INCLUDED	SUBMITTAL ITEMS
_____	Tab 1 Form of Bid (Attachment F)
_____	Tab 2 HUD Forms & Conflict of Interest Questionnaire(Attachment B)
_____	Tab 3 Profile of Firm Form, Company Profile (Attachment C)
_____	Tab 4 Client Information
_____	Tab 5 Joint Venture/Partnership Information
_____	Tab 6 Subcontractor Information
_____	Tab 7 Section 3 Preference
_____	Tab 8 S/W/MBE Small Business Plan
_____	Tab 9 Section 3 Good Faith Effort Compliance Plan
_____	Tab 10 Financial Viability and Other Information

SECTION 3 STATEMENT

Are you claiming a Section 3 business preference? YES___ or NO___. If “YES,” pursuant to the documentation justifying such submitted under Tab No. 8, which category are you claiming?

- _____ Category I – Owned by a public housing resident where work is performed
- _____ Category II – Owned by any other public housing resident
- _____ Category III – HUD Youth Build Program
- _____ Category IV – 30% of workforce is Section 3 qualified or sub-contract greater than 25% of contract value to certified Section 3 Business Concern

Bid Fee Sheet

The undersigned proposer hereby states that by completing and submitting this Form and all other documents within this submittal, he/she is verifying that all information provided herein is, to the best of his/her knowledge, true and accurate, and that if SAHA discovers that any information entered herein to be false, that shall entitle SAHA to not consider or make award or to cancel any award with the undersigned party. Further, by completing and submitting the submittal, and by entering the costs where provided, the undersigned is thereby agreeing to abide by all terms and conditions pertaining to this IFB as issued by SAHA, in hard copy. Pursuant to all IFB Documents, all attachments, and all completed Documents submitted by proposer, including these forms, addendums, and all attachments, the undersigned proposes to supply SAHA with the services described herein for the fee(s) entered within the areas provided.

Base Bid:

Description	Unit	Base Cost	Days to Complete
Rehabilitation of 7 Fire and Water damaged units	Job	\$	

If the Contractor fails to list days to complete, the project must be completed in 200 days from notification to begin work.

Unit Price items: Unit price items are for unforeseen or additional requested work and are used at the sole discretion of SAHA. Quantities are estimates only and do not represent any guarantee of quantities that may be purchased. Price must be fully burdened to purchase and install (turnkey) each item unit of measure.

Landscaping	UOM	Qty	Price per unit	Extension
R&R Water Proofing as per detail #9-Pg. A8	SQ.FT.	100	\$	\$
R&R 2"x 3" Yellow Pine Framing Lumber	LF.	200	\$	\$
R&R 2"x 2" Yellow Pine Framing Lumber	LF.	200	\$	\$
R&R 2"x 4" Yellow Pine Framing Lumber	LF.	200	\$	\$
R&R 2"x 6" Yellow Pine Framing Lumber	LF.	200	\$	\$
R&R 2"x 8" Yellow Pine Framing Lumber	LF.	200	\$	\$
R&R 2"x 10" Yellow Pine Framing Lumber	LF.	200	\$	\$
R&R 1/2" Plywood (Decking)	SQ.FT.	150	\$	\$
R&R 3/4" Plywood (Decking)	SQ.FT.	175	\$	\$
R&R 5/8" Plywood (Decking)	SQ.FT.	300	\$	\$
Install 4x4x1.63 four square electrical box	EA.	10	\$	\$
C.M.U Wall Repair	SQFT	95	\$	\$
Masonry Tuck & Point	SQ.FT.	300	\$	\$
Roofing (Composition Shingle)	SQ.FT.	70	\$	\$
Roofing (Metal)	SQ.FT.	30	\$	\$
R&R Cementitious Lap Siding 8.25" Smooth	LF.	200	\$	\$
R&R 1/4 Cementitious Soffit smooth perforated	SQ.FT.	200	\$	\$
R&R 1/4 Cementitious Facia	LF.	100	\$	\$
1/2 Copper Pipe (L)	LF.	75	\$	\$
3/4 Copper Pipe (L)	LF.	90	\$	\$
Existing window repair (Glass replacement)	SQFT	60	\$	\$
Fire Caulking	LF.	200	\$	\$
Pipe Insulation 1/2	LF.	100	\$	\$
Pipe Insulation 3/4	LF.	100	\$	\$
Company Name:				

Description	UOM	Qty	Price per unit	Extension
Stair Tread replacement wood (interior)	EA.	15	\$	\$
Blocking (walls) 2x6	LF.	100	\$	\$
Base boards	LF.	200	\$	\$
Moisture resistant gypsum board 5/8	SQFT	100	\$	\$
Mold resistant gypsum board 5/8	SQFT	100	\$	\$
Covebase	LF.	200	\$	\$
Caulk	LF.	550	\$	\$
Exterior water proofing	SQFT	200	\$	\$
Tile Ceramic	SQFT	100	\$	\$
LW1216ER / LG Electronics 12,000 BTU Energy Star Window Air Conditioner w/ Remote (115V LW1216ER)	EA.	7	\$	\$

****R & R = Remove and Replace****

Addenda Acknowledgements

Addendum #1 _____ Date _____

Addendum #2 _____ Date _____

Addendum #3 _____ Date _____

_____ Signature	_____ Date
_____ Printed Name	_____ Company
_____ E-mail address if available	
_____ Phone	_____ Fax

